

Display Elektronik GmbH

DATA SHEET

LCD MODULE

DEM 16214 SYH-LY

Product specification

Version : 5

04.04.2003

GENERAL SPECIFICATION

MODULE NO. :

DEM 16214 SYH-LY

CUSTOMER P/N

VERSION NO.	CHANGE DESCRIPTION	DATE
0	ORIGINAL VERSION	2001/02/10
1	ADDING VERSION	2001/02/20
2	ADDING VERSION	2001/06/12
3	ADDING VERSION	2001/08/27
4	VIEWING DIRECTION CHANGED	2002/04/09
5	VIEWING DIRECTION CHANGED	2002/04/25

PREPARED BY: HZJ

DATE: 2002/04/25

APPROVED BY: MH

DATE: 2003/04/04

CONTENTS

1. FUNCTIONS & FEATURES----- 2

2. MECHANICAL SPECIFICATIONS ----- 2

3. BLOCK DIAGRAM ----- 2

4. EXTERNAL DIMENSIONS ----- 3

5. PIN ASSIGNMENT----- 3

6.1 PCB DRAWING AND DESCRIPTION----- 4

6.2 EXAMPLE APPLICATION----- 5

6.3 THE MODULE NO. IS PRINTED ON THE PCB----- 5

7. BACKLIGHT & SWITCH----- 6

8. DISPLAY DATA RAM (DDRAM)----- 6

9. INSTRUCTION DESCRIPTION----- 7

10. INTERFACE WITH MPU IN BUS MODE----- 11

 1) INTERFACE WITH 8-BIT MPU ----- 11

 2) INTERFACE WITH 4-BIT MPU ----- 11

11. INITIALIZING BY INSTRUCTION ----- 12

 11-1 8-BIT INTERFACE MODE ----- 12

 11-2 4-BIT INTERFACE MODE ----- 13

12. MAXIMUM ABSOLUTE POWER RATINGS ----- 14

13. ELECTRICAL CHARACTERISTICS----- 14

 13-1-1 DC CHARACTERISTICS----- 14

 13-2-1 AC CHARACTERISTICS----- 16

 13-2-2 WRITE MODE----- 17

 13-2-3 READ MODE----- 17

14. CHARACTER GENERATOR ROM (KS0070B-00)----- 18

15. FRAME FREQUENCY ----- 19

16. LCD MODULES HANDLING PRECAUTIONS ----- 20

17. OTHERS ----- 20

1. FUNCTIONS & FEATURES

- DEM 16214-Series LCD type :

MODULE-TYPE	LCD-MODEL	LCD-TYPE
DEM 16214 SYH-LY	STN Silvergrey	Transflective Positive Mode

- Viewing Direction : 6 O'clock
- Driving Scheme : 1/16 Duty Cycle, 1/5 Bias
- Power Supply Voltage : 2.7V to 5.5V (typ. 5V)
- Backlight : Yellow/Green (lightbox)
- V_{LCD} Adjustable For Best Contrast : 4.5V (typ.)
- Display Format : 16 x 2 Characters (5 x 8 dots, Format : 192 Kinds)
- Internal Memory : CGROM (8,320 bits)
: CGRAM (64 x 8 bits)
: DDRAM (80 x 8 bits for 80 Digits)
- Easy Interface with a 4-bit or 8-bit MPU

2. MECHANICAL SPECIFICATIONS

- Character Pitch : 4.82 (W) x 8.26 (H) mm
- Character Size : 4.07 (W) x 7.76 (H) mm
- Character Font : 5 x 8 dots
- Dot Size : 0.75 (W) x 0.90 (H) mm
- Dot Pitch : 0.83 (W) x 0.98 (H) mm

3. BLOCK DIAGRAM

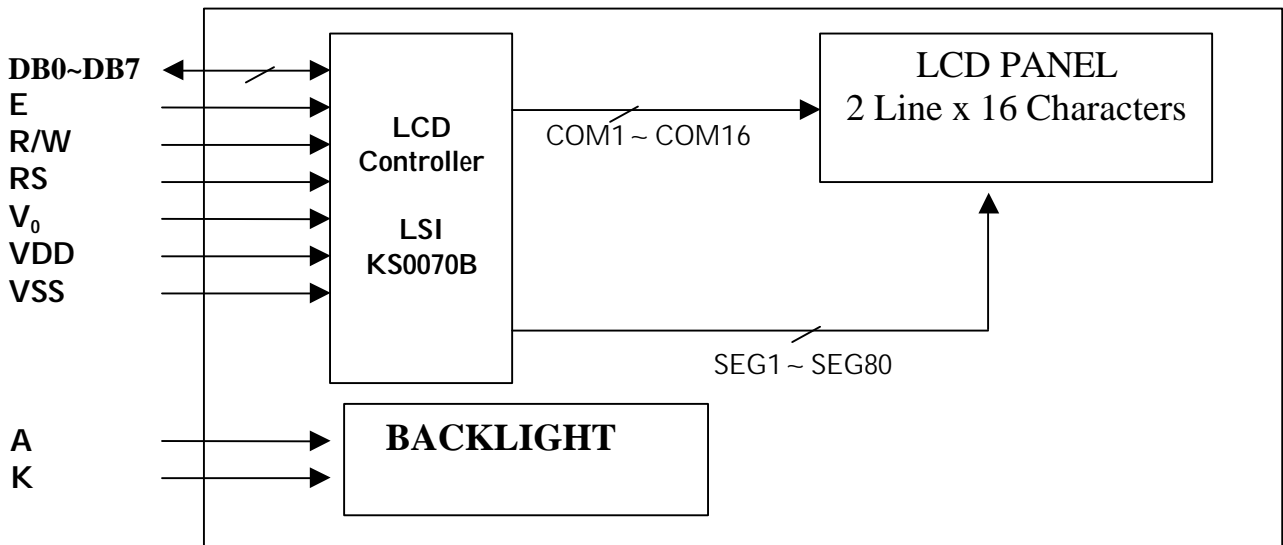

Figure 1.0

4. EXTERNAL DIMENSIONS

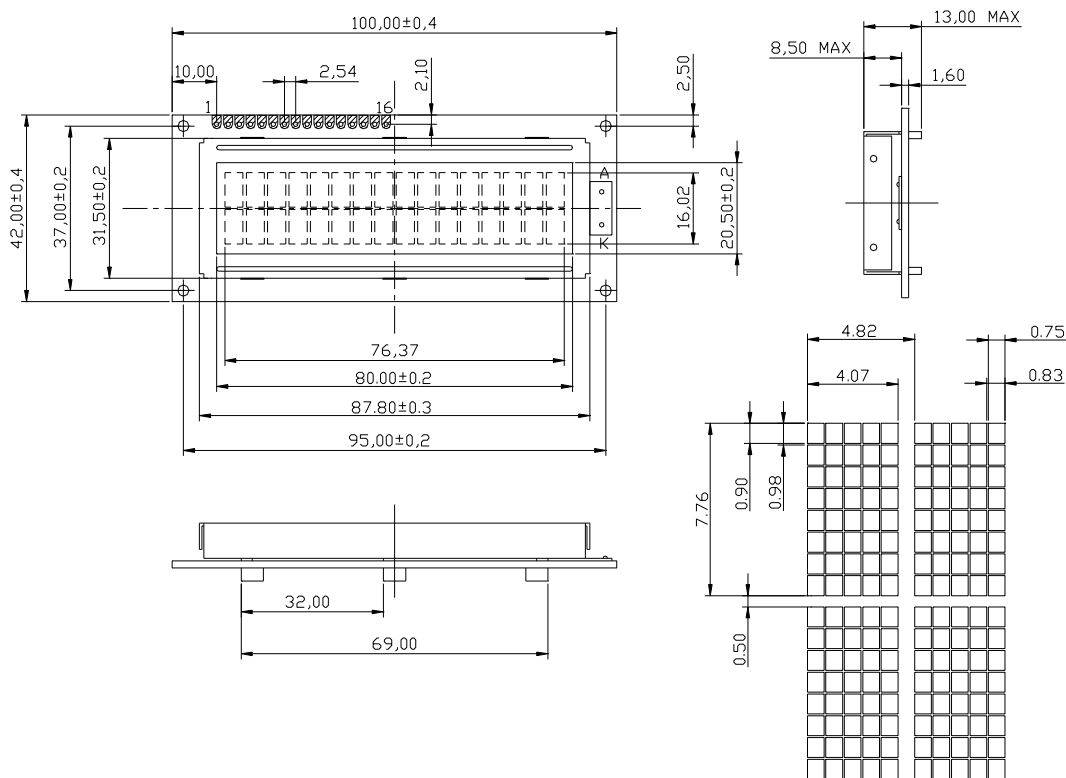

Figure 2.0

5. PIN ASSIGNMENT

Pin No.	Symbol	Function
1	VSS	Ground terminal of module.
2	VDD	Supply terminal of module 2.7V to 5.5V.
3	V0	Power Supply for liquid crystal drive.
4	RS	Register select RS = 0...Instruction register RS = 1...Data register
5	R/W	Read /Write R/W = 1...Read R/W = 0...Write
6	E	Enable
7	DB0	Bi-directional data bus, data transfer is performed once, thru DB0 to DB7, in the case of interface data. Length is 8-bits; and twice, thru DB4 to DB7 in the case of interface data length is 4-bits. Upper four bits first then lower four bits.
8	DB1	
9	DB2	
10	DB3	
11	DB4	
12	DB5	
13	DB6	
14	DB7	
15	LED – (K)	Please also refer to 6.1 PCB drawing and description.
16	LED + (A)	Please also refer to 6.1 PCB drawing and description.

6.1 PCB DRAWING AND DESCRIPTION

Top Layer:

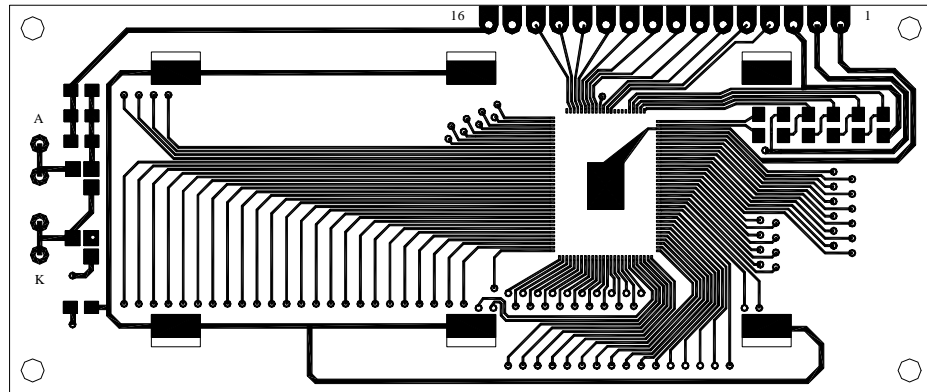

Bottom Layer:

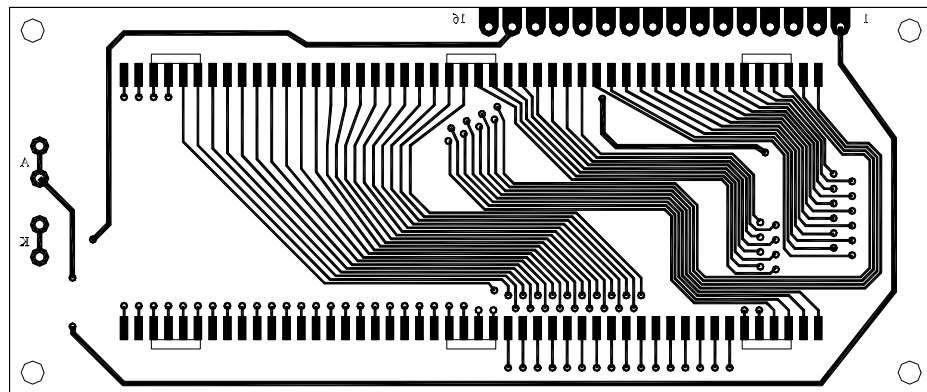

Figure 3.0

DESCRIPTION:

6-1-1. The polarity of the pin 15 and the pin 16:

symbol	symbol state	J3, J5	J2, J4	LED Polarity	
				15 Pin	16 Pin
J2, J4	Each solder-bridge	Each open	-----	Anode	Cathode
J3, J5	Each solder-bridge	-----	Each open	Cathode	Anode

6-1-2. The metal-bezel should be on ground when the J1 is solder-Bridge.

6-1-3. The LED resistor should be bridged when the J6 is solder-Bridge.

6-1-4. The R7=33 Ohm and the R8=33 Ohm are the LED resistors.

6.2 Example application

6-2-1. The LED resistor should be bridged as following.

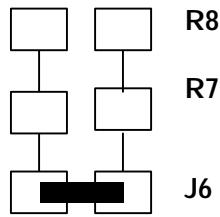

6-2-2. The 15 pin is the anode and the 16 pin is the cathode as following.



6-2-3. The 15 pin is the cathode and the 16 pin is the anode as following.



6-2-4. The metal-bezel is on ground as following.



6.3 The module No. is printed on the PCB.

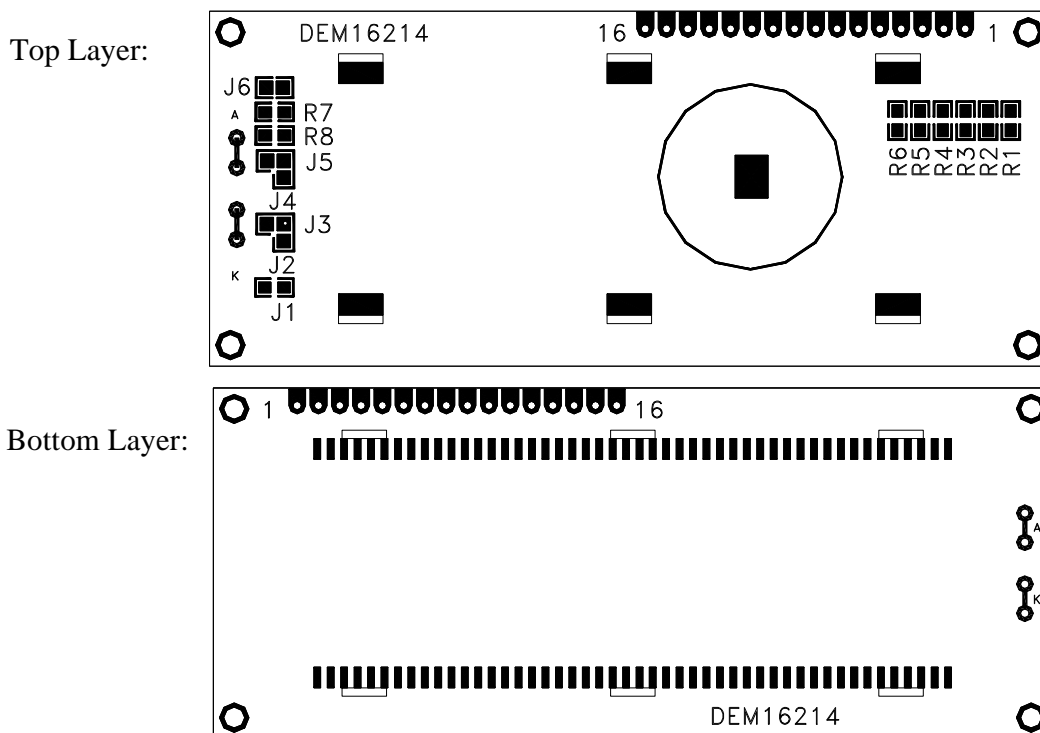

Figure 4.0

7. BACKLIGHT & SWITCH (Ta = -20 ~ +70°C)

Item	Symbol	Standard Value	Unit	Applicable Terminal
Backlight Voltage	V	5.0	V	LED+ / LED- (Pin15/16)
Backlight Current	I	55	mA	

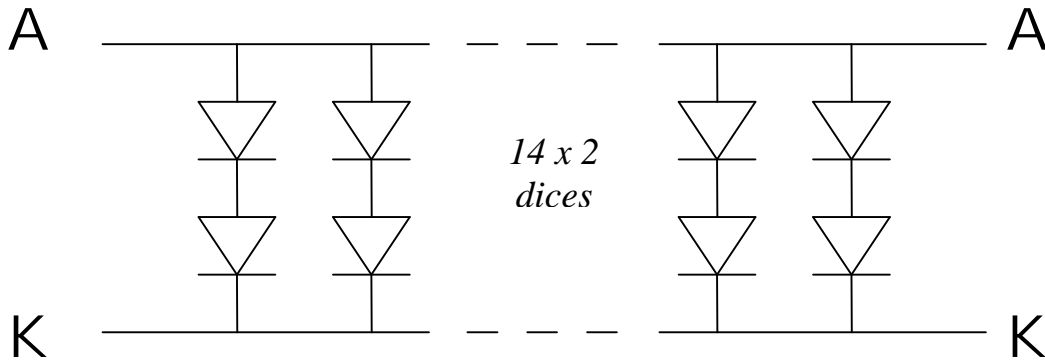

Figure 5.0

8. DISPLAY DATA RAM (DDRAM)

	1	2	3	4	5	6	7	8	9	10	11	12	13	14	15	16	← DISPLAY POSITION
FIRST LINE	00	01	02	03	04	05	06	07	08	09	0A	0B	0C	0D	0E	0F	← DDRAM ADDRESS
SECOND LINE	40	41	42	43	44	45	46	47	48	49	4A	4B	4C	4D	4E	4F	

9. INSTRUCTION DESCRIPTION

Outline

To overcome the speed difference between the internal clock of KS0070B and the MPU clock, KS0070B performs internal operations by storing control information to IR or DR. The internal operation is determined according to the signal from MPU, composed of read/write and data bus (refer to table 5.)

Instruction can be divided largely into four kinds:

- (1) KS0070B function set instructions (set display methods, set data length, etc.)
- (2) Address set instructions to internal RAM.
- (3) Data transfer instructions with internal RAM.
- (4) Others.

The address of the internal RAM is automatically increased or decreased by 1.

*NOTE: During internal operation, busy flag (DB7) is read "1". Busy flag check must be preceded by the next instruction.

When you make an MPU program with checking the busy flag (DB7), it must be necessary 1/2 fosc for executing the next instruction by falling E signal after the busy flag (DB7) goes to "0".

Contents

1) Clear display

RS	R/W	DB7	DB6	DB5	DB4	DB3	DB2	DB1	DB0
0	0	0	0	0	0	0	0	0	1

Clear all the display data by writing "20H" (space code) to all DDRAM address, and set the DDRAM addresses to "00H" in the AC (address counter). Return cursor to original status, namely, bring the cursor to the left edge on first line of the display. Make entry mode increment (I/D = "1").

2) Return home

RS	R/W	DB7	DB6	DB5	DB4	DB3	DB2	DB1	DB0
0	0	0	0	0	0	0	0	1	x

Return home is the cursor return home instruction.

Set DDRAM address to "00H" in the address counter. Return cursor to its original site and return display to its original status, if shifted. Contents of DDRAM does not change.

3) Entry mode set

RS	R/W	DB7	DB6	DB5	DB4	DB3	DB2	DB1	DB0
0	0	0	0	0	0	0	1	I/D	SH

Set the moving direction of cursor and display.

I/D: increment/decrement of DDRAM address is increased by 1.

When I/D = "1", cursor/blink moves to right and DDRAM address is increased by 1.

When I/D = "0", cursor/blink moves to left and DDRAM address is increased by 1.

CGRAM operates the same as DDRAM, when reading from or writing to CGRAM.

SH: shift of entire display

When DDRAM is in read (CGRAM read/write) operation or SH = "0", shift of entire display is not performed.

If SH = "1" and in DDRAM write operation, shift of entire display is performed according to I/D value (I/D = "1": shift left, I/D = "0": shift right).

4) Display ON/OFF control

RS	R/W	DB7	DB6	DB5	DB4	DB3	DB2	DB1	DB0
0	0	0	0	0	0	1	D	C	B

Control display/cursor/blink ON/OFF 1-bit register.

D: Display ON/OFF control bit

When D = "1", entire display is turned on.

When D = "0", display is turned off, but display data remains in DDRAM.

C: cursor or ON/OFF control bit

When C = "1", cursor is turned on.

When C = "0", cursor disappears in current display, but I/D register retains its data.

B: cursor blink ON/OFF control bit

When B = "1", cursor blink is on, which performs alternately between all the "1" data and display characters at the cursor position.

When B = "0", blink is off

5) Cursor or display shift

RS	R/W	DB7	DB6	DB5	DB4	DB3	DB2	DB1	DB0
0	0	0	0	0	1	S/C	R/L	X	X

Without writing or reading the display data, shift right/left cursor position or display.

This instruction is used to correct or search display data. (refer to table 40)

During 2-line mode display, cursor moves to the 2nd line after the 40th digit of the 1st line.

Note that display shift is performed simultaneously in all the lines.

When displayed data is shifted repeatedly, each line shifts individually.

When display shift is performed, the contents of the address counter are not changed.

Table 4. shift patterns according to S/C and R/L bits

S/C	R/L	operation
0	0	Shift cursor to the left, AC is decreased by 1
0	1	Shift cursor to the right, AC is decreased by 1
1	0	Shift all the display to the left, cursor moves according to the display
1	1	Shift all the display to the right, cursor moves according to the display

6) Function set

RS	R/W	DB7	DB6	DB5	DB4	DB3	DB2	DB1	DB0
0	0	0	0	0	DL	N	F	X	X

DL: Interface data length control bit
 When DL = "1", it means 8-bit bus mode with MPU.

When DL = "0", it means 4-bit bus mode with MPU. So to speak, DL is a signal to select 8-bit or 4-bit bus mode. When 4-bit bus mode, it needs to transfer 4-bit data in two parts.

N: display line number control bit
 When N = "0", it means 1-line display mode.
 When N = "1", it means 2-line display mode.

F: display font type control bit
 When F = "0", 5 x 7 dots format display mode.
 When F = "1", 5 x 10 dots format display mode.

7) Set CGRAM address

RS	R/W	DB7	DB6	DB5	DB4	DB3	DB2	DB1	DB0
0	0	0	1	AC5	AC4	AC3	AC2	AC1	AC0

Set CGRAM address to AC.
 THIS INSTRUCTION MAKES CGRAM data available from MPU.

8) Set DDRAM address

RS	R/W	DB7	DB6	DB5	DB4	DB3	DB2	DB1	DB0
0	0	1	AC6	AC5	AC4	AC3	AC2	AC1	AC0

Set DDRAM address to AC
 This instruction makes DDRAM data available from MPU.
 When in 1-line display mode (N=0), DDRAM address is from "00H" to "4FH".
 In 2-line display mode (N=1), DDRAM address in the 1st line is from "00H" to "27H", and DDRAM address in the 2nd line is from "40H" to "67H".

9) Read busy flab & address

RS	R/W	DB7	DB6	DB5	DB4	DB3	DB2	DB1	DB0
0	0	BF	AC6	AC5	AC4	AC3	AC2	AC1	AC0

This instruction shows whether KS0070B is in internal operation or not. If the resultant BF is "1", it means the internal operation is in progress and you have to wait until BF is low. Then the next instruction can be performed. In this instruction you can also read the value of the address counter.

10) Write data to RAM

RS	R/W	DB7	DB6	DB5	DB4	DB3	DB2	DB1	DB0
1	0	D7	D6	D5	D4	D3	D2	D1	D0

Write binary 8-bit data to DDRAM / CGRAM
 The selection of RAM from DDRAM, and CGRAM, is set by the previous address set instruction: DDRAM address set, and CGRAM address set. RAM set instruction can also determine the AC direction to RAM.
 After write operation, the address is automatically increased/decreased by 1, according to the entry mode.

11) Read data to RAM

RS	R/W	DB7	DB6	DB5	DB4	DB3	DB2	DB1	DB0
1	1	D7	D6	D5	D4	D3	D2	D1	D0

Read binary 8-bit data from DDRAM/CGRAM.

The selection of RAM is set by the previous address set instruction. If the address set instruction of RAM is not performed before this instruction, the data that is read first is invalid, because the direction of AC is not determined. If you read RAM data several times without RAM address set instruction before read operation, you can get correct RAM data. In the case of DDRAM read operation, cursor shift instruction plays the same role as DDRAM address set instruction; it also transfers RAM data to the output data register.

After read operation the address counter is automatically increased/decreased by 1 according to the entry mode. After CGRAM read operation, display shift may not be executed correctly.

In the case of RAM write operation, after this AC is increased/decreased by 1 like read operation. At his time, AC indicates the next address position, but your can read only the previous data by the read instruction.

Table 5.instruction table

Instruction	Instruction Code										Description	Execution time (fosc = 270kHz)	
	RS	R/W	DB7	DB6	DB5	DB4	DB3	DB2	DB 1	DB0			
Clear Display	0	0	0	0	0	0	0	0	0	0	1	Write "20H" to DDRAM and set DDRAM address to "00H" from AC.	1.53 ms
Return Home	0	0	0	0	0	0	0	0	0	1	x	Set DDRAM address to "00H" from AC and return cursor to its original position if shifted.	1.53ms
Entry Mode set	0	0	0	0	0	0	0	0	1	I/D	SH	Assign cursor moving direction and enable the shift of entire display.	39us
Display ON/OFF Control	0	0	0	0	0	0	0	1	D	C	B	Set display (D), cursor(C), and blinking of cursor (B) on/off control bit.	39us
Cursor or Display shift	0	0	0	0	0	0	1	S/C	R/L	X	X	Set cursor moving and display shift control bit, and the direction without changing of DDRAM data.	39us
Function set	0	0	0	0	1	DL	N	F	X	X	X	Set interface data length (DL:4-bit/8-bit), numbers of display line (N:1-line/2-line, display font type (F:0...))	39us
Set CGRAM address	0	0	0	1	AC5	AC4	AC3	AC2	AC 1	AC0	AC0	Set CGRAM address in address counter.	39us
Set CGRAM address	0	0	1	AC6	AC5	AC4	AC3	AC2	AC 1	AC0	AC0	Set DDRAM address in address counter.	39us
Read busy flag and address	0	1	BF	AC6	AC5	AC4	AC3	AC2	AC 1	AC0	AC0	Whether during internal operation or not can be known by reading BF. The contents of address counter can also be read.	0us
Write data to RAM	1	0	D7	D6	D5	D4	D3	D2	D1	D0	D0	Write data into internal RAM (DDRAM/CGRAM).	43us
Read data to RAM	1	1	D7	D6	D5	D4	D3	D2	D1	D0	D0	Read data into internal RAM (DDRAM/CGRAM).	43us

NOTE: when you make an MPU program with checking the busy flag (DB7), it must be necessary 1/2 Fosc for executing the next instruction by falling E signal after the busy flag (DB7) goes to "0".

10. INTERFACE WITH MPU IN BUS MODE

1) Interface with 8-bit MPU

When interfacing data length are 8-bit, transfer is performed all at once through 8-ports, from DB0 to DB7. An example of the timing sequence is shown below.

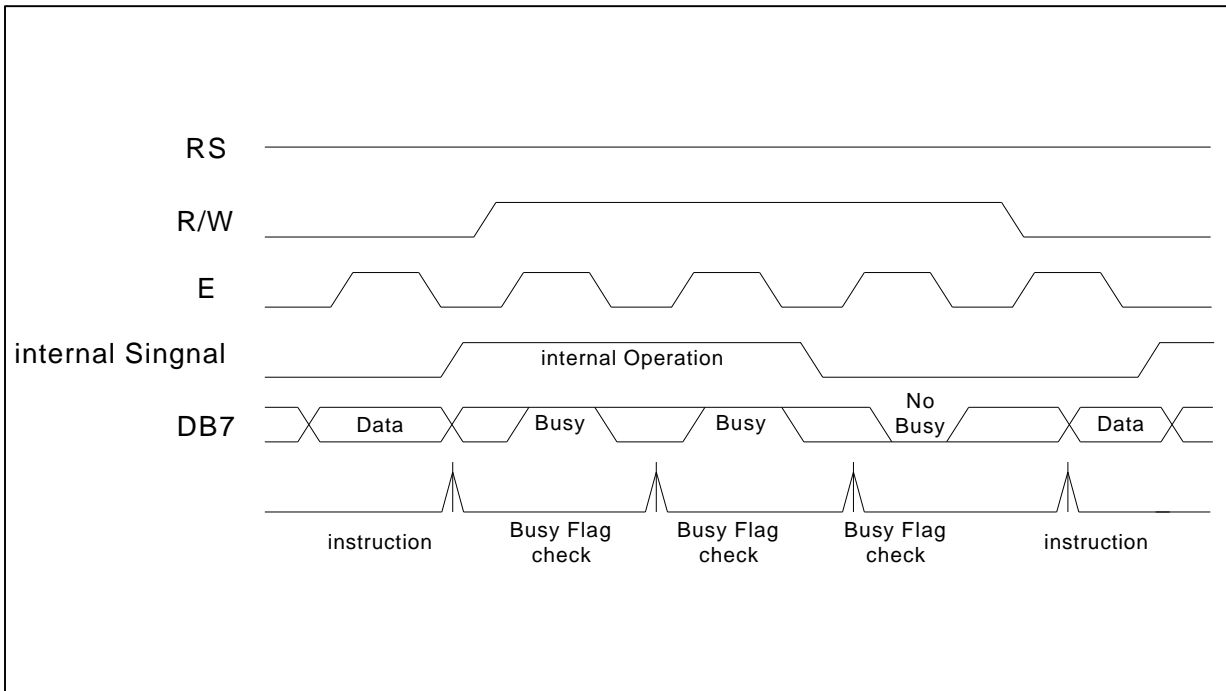

Figure 6.0 Example of 8-bit bus mode timing diagram

2) Interface with 4-bit MPU

When interfacing data length are 4-bit, only 4 ports, from DB4 to DB7, are used as data bus. At first, higher 4-bit (in case of 8-bit bus mode, the contents of DB4 to DB7) are transferred, and then the lower 4-bit (in case of 8-bit bus mode, the contents of DB0 to DB3) are transferred. So transfer is performed in two parts. Busy flag outputs "1" after the second transfer are ended. Example of timing sequence is shown below.

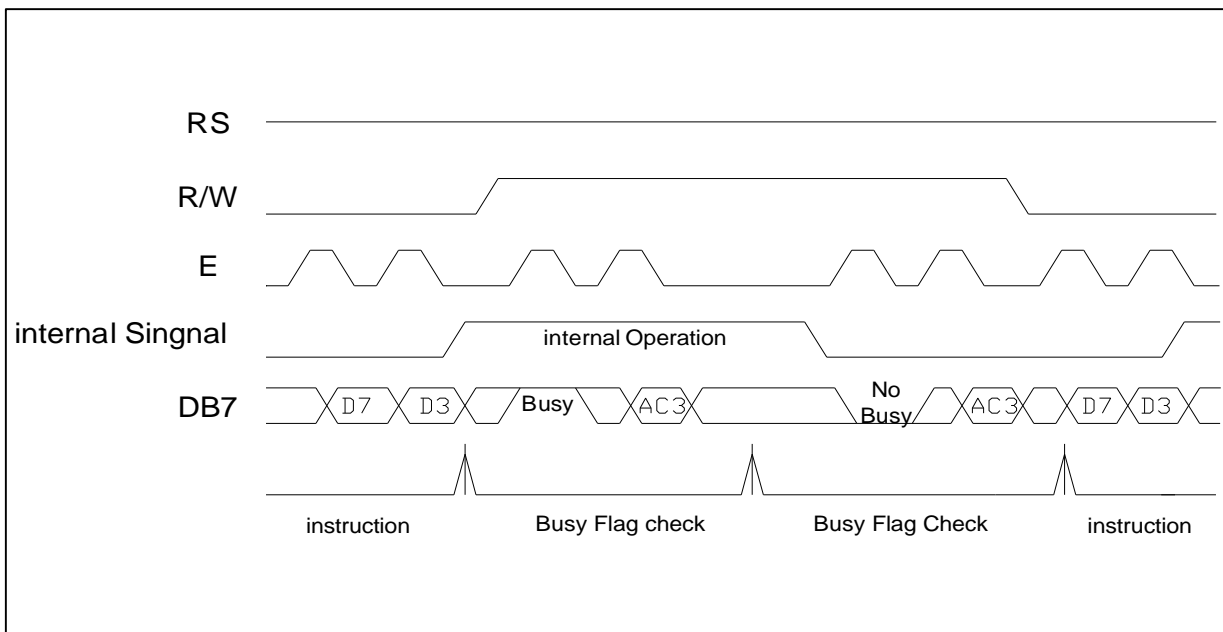
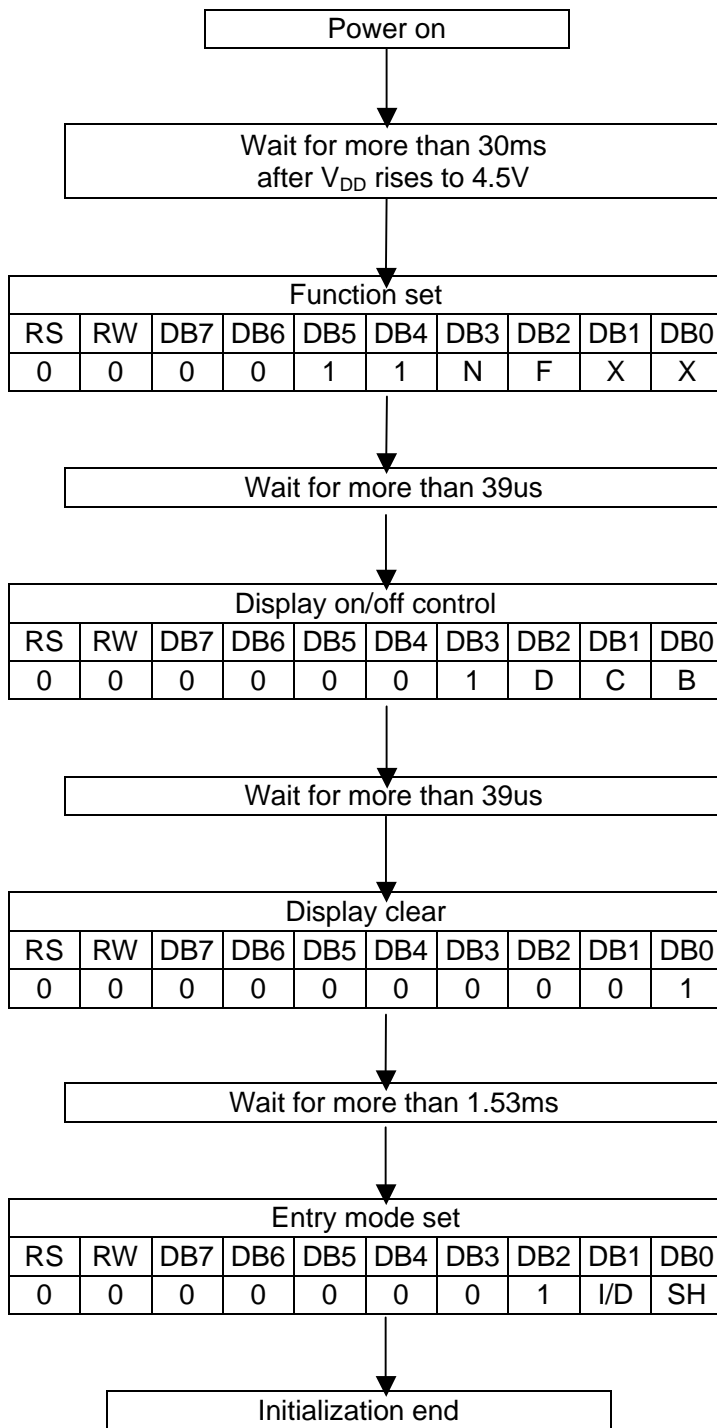

Figure 7.0 Example of 4-bit bus mode timing diagram

11. INITIALIZING BY INSTRUCTION

11-1. 8-bit interface mode



Condition : fosc=270khz

N	0	1-line mode
	1	2-line mode

F	0	5 x 7 dots
	1	5 x 10 dots

D	0	display off
	1	display on

C	0	cursor off
	1	cursor on

B	0	blink off
	1	blink on

I/D	0	decrement mode
	1	increment mode

SH	0	entire shift off
	1	entire shift on

11-2. 4-bit interface mode

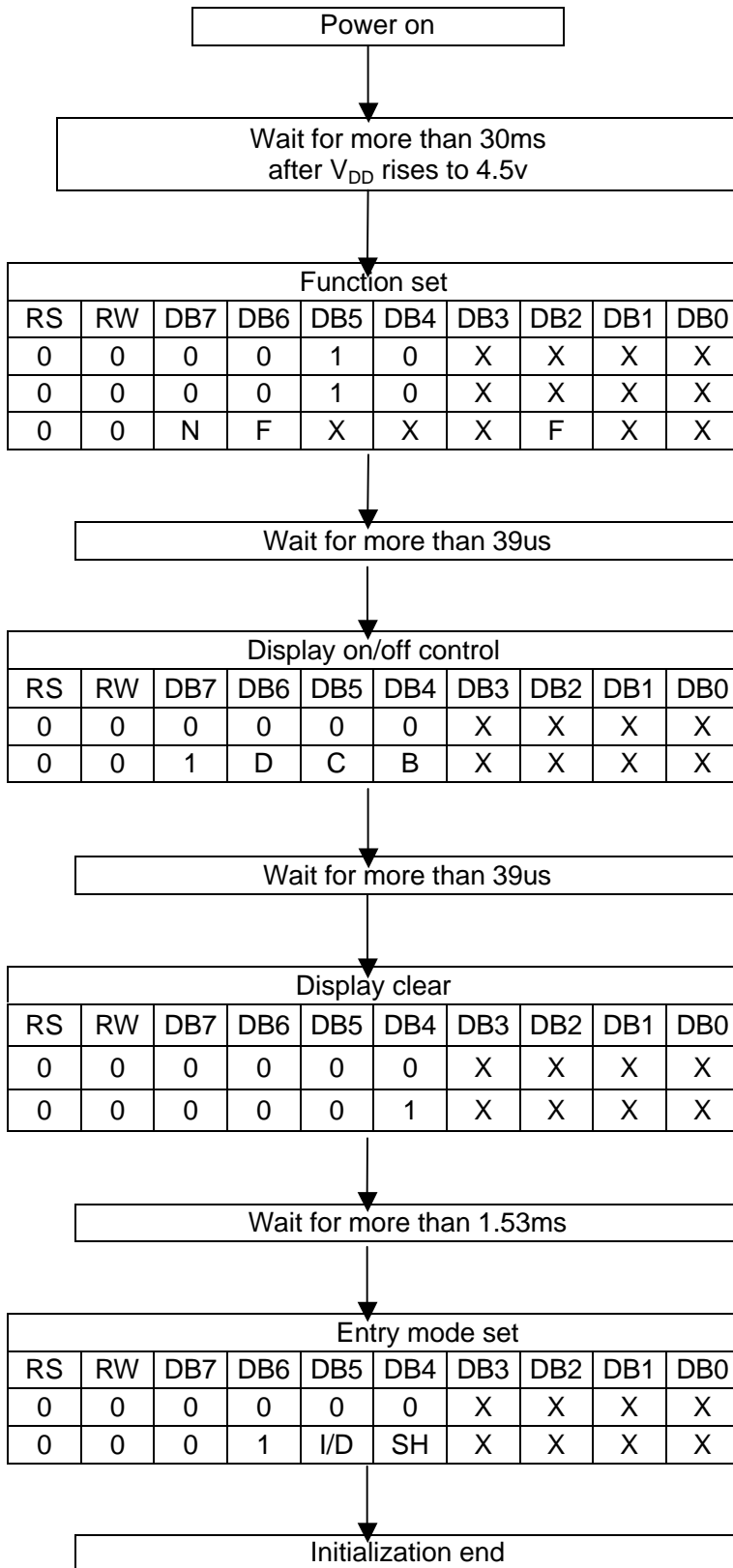

Condition : fosc=270khz

N	0	1-line mode
	1	2-line mode
F	0	5 x 7 dots
	1	5 x 10 dots

D	0	display off
	1	Display on
C	0	cursor off
	1	cursor on
B	0	blink off
	1	blink on

I/D	0	decrement mode
	1	increment mode
SH	0	entire shift off
	1	entire shift on

12. MAXIMUM ABSOLUTE POWER RATINGS (Ta = 25°C)

Item	Symbol	Standard value	Unit
Power supply voltage(1)	V _{DD}	-0.3~+7.0	V
Power supply voltage(2)	V _{LCD}	V _{DD} -15.0~V _{DD} +0.3	V
Input voltage	V _{IN}	-0.3~V _{DD} +0.3	V
Volt. For BL	V _{LED1}	4~4.5	V
Operating temperature	T _{opr}	-20~+70	°C
Storage temperature	T _{stg}	-30~+80	°C

13. ELECTRICAL CHARACTERISTICS

13-1-1 DC Characteristics (VDD = 4.5V ~ 5.5V, Ta = -20 ~ +70°C)

Item	Symbol	Standard Value			Test Condition	Unit
		MIN	TYP	MAX		
Operating Voltage	V _{DD}	4.5	---	5.5	-----	V
Supply Current	I _{DD1}	----	0.7	1.0	Ceramic oscillation fosc = 250kHz	mA
	I _{DD2}	----	0.4	0.6	Resistor oscillation external clock operation fosc = 270kHz	
Input Voltage(1) (except OSC1)	V _{IL1}	-0.3	--	0.6	-----	V
	V _{IH1}	2.2	--	V _{DD}	-----	
Input Voltage(2) (OSC1)	V _{IL2}	-0.2	--	1.0	-----	V
	V _{IH2}	V _{DD} -1.0	--	V _{DD}	-----	
Output Voltage (1) (DB0 to DB7)	V _{OL1}	---	----	0.4	I _{OL} = 1.2uA	V
	V _{OH1}	2.4	---	----	I _{OH} = -0.205mA	
Output Voltage (2) (except DB0 to DB7)	V _{OL2}	-----	---	0.1V _{DD}	I _{OL} = 40uA	V
	V _{OH2}	0.9V _{DD}	---	----	I _{OH} = -40uA	
Voltage Drop	V _{dCOM}	----	---	1	I _o = ± 0.1 mA	V
	V _{dSEG}	-----	---	1		
Input Leakage Current	I _{IL}	-1	---	1	V _{IN} = 0 V to V _{DD}	uA
Input Low Current	I _{IN}	-50	-125	-250	V _{IN} = 0V, V _{DD} = 5V(pull up)	uA
Internal Clock (external Rf)	f _{IC}	190	270	350	Rf = 91kΩ ± 2% (V _{DD} = 5V)	kHz
External Clock	f _{EC}	150	250	350	----	kHz
	Duty	45	50	55	----	%
	t _R , t _F	---	---	0.2	----	us
LCD Driving Voltage	V _{LCD}	4.6	---	10.0	V _{DD} -V ₅ (1/5, 1/4 Bias)	V

(CONTINUED)

(VDD = 2.7V ~ 4.5V, Ta = -25 ~ +75°C)

Item	Symbol	Standard Value			Test Condition	Unit
		MIN	TYP	MAX		
Operating Voltage	V _{DD}	2.7	---	4.5	-----	V
Supply Current	I _{DD1}	----	0.3	0.5	Ceramic oscillation fosc = 250kHz	mA
	I _{DD2}	----	0.17	0.3	Resistor oscillation external clock operation fosc = 270kHz	
Input Voltage(1) (except OSC1)	V _{IL1}	-0.3	--	0.4	-----	V
	V _{IH1}	0.7V _{DD}	--	V _{DD}	-----	
Input Voltage(2) (OSC1)	V _{IL2}		--	0.2V _{DD}	-----	V
	V _{IH2}	0.7V _{DD}	--	V _{DD}	-----	
Output Voltage (1) (DB0 to DB7)	V _{OL1}	---	----	0.4	I _{OL} = 0.1mA	V
	V _{OH1}	2.0	---	----	I _{OH} = -0.1mA	
Output Voltage (2) (except DB0 to DB7)	V _{OL2}	-----	---	0.2V _{DD}	I _{OL} = 40uA	V
	V _{OH2}	0.8V _{DD}	---	----	I _{OH} = -40uA	
Voltage Drop	V _{dCOM}	----	---	1	I _o = ± 0.1 mA	V
	V _{dSEG}	-----	---	1.5		
Input Leakage Current	I _{IL}	-1	---	1	V _{IN} = 0 V to V _{DD}	uA
Input Low Current	I _{IN}	-10	-50	-120	V _{IN} = 0V, V _{DD} = 3V(pull up)	uA
Internal Clock (external Rf)	f _{IC}	190	250	350	Rf = 75kΩ ± 2% (V _{DD} = 3V)	kHz
External Clock	f _{EC}	125	270	350	----	kHz
	Duty	45	50	55	----	%
	t _R , t _F	---	---	0.2	----	us
LCD Driving Voltage	V _{LCD}	3.0	---	10.0	V _{DD} - V ₅ (1/5, 1/4 Bias)	V

13-2-1 AC Characteristics

($V_{DD} = 4.5V \sim 5.5V$, $T_a = -25 \sim 75^{\circ}C$)

Mode	Item	Symbol	Min	Typ	Max	Unit
(1) Write Mode (refer to Figure 8.0)	E Cycle Time	t_C	500	---	---	ns
	E Rise/Fall Time	t_R, t_F	---	---	25	
	E Pulse Width (High, Low)	t_w	220	---	---	
	R/W and RS Setup Time	t_{su1}	40	---	---	
	R/W and RS Hold Time	t_{H1}	10	---	---	
	Data Setup Time	t_{su2}	60	---	---	
	Data Hold Time	t_{H2}	10	---	---	
(2) Read Mode (refer to Figure 9.0)	E Cycle Time	t_C	500	---	---	ns
	E Rise/Fall Time	t_R, t_F	---	---	25	
	E Pulse Width (High, Low)	t_w	220	---	---	
	R/W and RS Setup Time	t_{su}	40	---	---	
	R/W and RS Hold Time	t_H	10	---	---	
	Data Out Delay Time	t_D	---	---	120	
	Data Hold Time	t_{DH}	20	---	---	

($V_{DD} = 2.7V \sim 4.5V$, $T_a = -20 \sim +70^{\circ}C$)

Mode	Item	Symbol	Min	Typ	Max	Unit
(3) Write Mode (refer to Figure 8.0)	E Cycle Time	t_C	1400	---	---	ns
	E Rise/Fall Time	t_R, t_F	---	---	25	
	E Pulse Width (High, Low)	t_w	400	---	---	
	R/W and RS Setup Time	t_{su1}	60	---	---	
	R/W and RS Hold Time	t_{H1}	20	---	---	
	Data Setup Time	t_{su2}	140	---	---	
	Data Hold Time	t_{H2}	10	---	---	
(4) Read Mode (refer to Figure 9.0)	E Cycle Time	t_C	1400	---	---	ns
	E Rise/Fall Time	t_R, t_F	---	---	25	
	E Pulse Width (High, Low)	t_w	450	---	---	
	R/W and RS Setup Time	t_{su}	60	---	---	
	R/W and RS Hold Time	t_H	20	---	---	
	Data Out Delay Time	t_D	---	---	360	
	Data Hold Time	t_{DH}	5	---	---	

13-2-2 Write mode

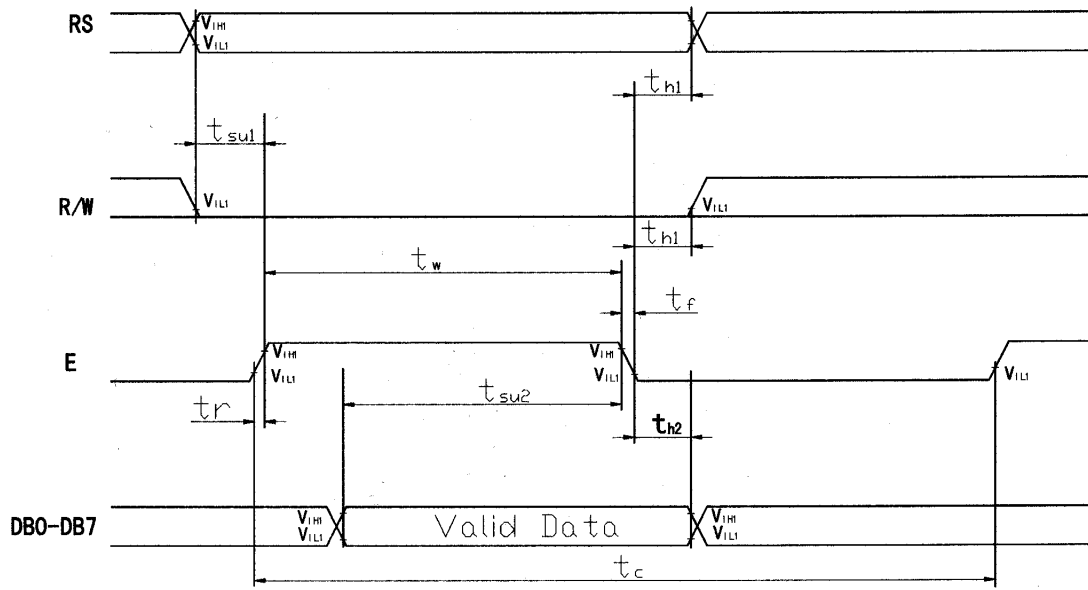

Figure 8.0

13-2-3 Read mode

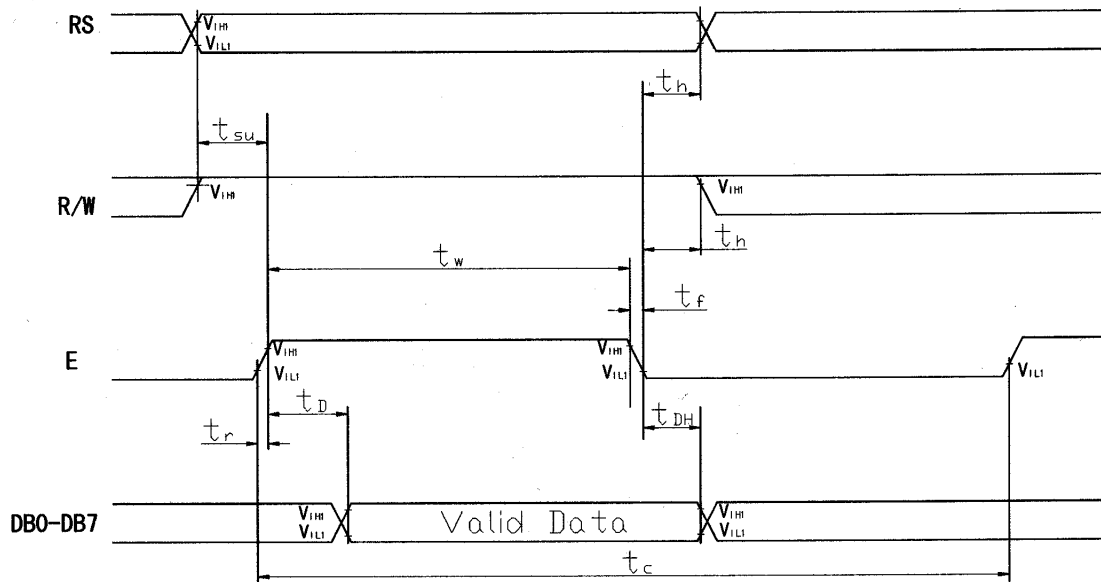

Figure 9.0

14. CHARACTER GENERATOR ROM (KS0070B-00)

Upper(4bit) \ Lower(4bit)	LLLL	LLHL	LLHH	LHLL	LHLH	LHHL	LHHH	HLLL	HLLH	HLHL	HLHH	HHLL	HHLH	HHHL	HHHH
LLLL	CG RAM (1)														
LLLH	(2)														
LLHL	(3)														
LLHH	(4)														
LHLL	(5)														
LHLH	(6)														
LHHL	(7)														
LHHH	(8)														
HLLL	(1)														
HLLH	(2)														
HLHL	(3)														
HLHH	(4)														
HHLL	(5)														
HHLH	(6)														
HHHL	(7)														
HHHH	(8)														

Table 3. Relationship Between character Code (DDRAM) and Character Pattern (CGRAM)

Character Code (DDRAM data)								CGRAM Address						CGRAM Data								Pattern number
D7	D6	D5	D4	D3	D2	D1	D0	A5	A4	A3	A2	A1	A0	P7	P6	P5	P4	P3	P2	P1	P0	
0	0	0	0	x	0	0	0	0	0	0	0	0	0	x	x	x	0				0	Pattern 1
											0	0	1					0	0	0		
											0	1	0					0	0	0		
											0	1	1					0	0	0		
											1	0	0					0	0	0		
											1	0	1					0	0	0		
											1	1	0					0	0	0		
											1	1	1				0	0	0	0	0	
0	0	0	0	x	1	1	1	1	1	1	0	0	0	x	x	x		0	0	0		Pattern 8
											0	0	1					0	0	0		
											0	1	0					0	0	0		
											0	1	1					0	0	0		
											1	0	0					0	0	0		
											1	0	1					0	0	0		
											1	1	0					0	0	0		
											1	1	1				0	0	0	0	0	

"x": don't care

15. FRAME FREQUENCY (1/16 duty cycle)

A-type Waveform

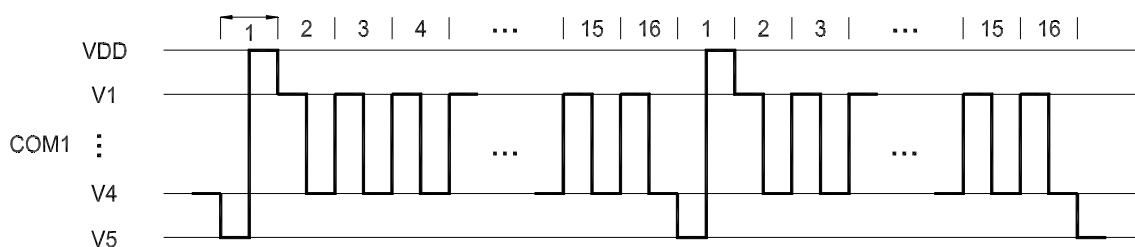

Item	Clock / Frequency
Line selection period	200 clocks
Frame frequency	84.4 Hz

* fosc = 270 kHz (1 clock = 3.7 us)

Figure 10.0

16. LCD Modules Handling Precautions

- The display panel is made of glass. Do not subject it to a mechanical shock by dropping it from a high place, etc.
- If the display panel is damaged and the liquid crystal substance inside it leaks out, do not get any in your mouth. If the substance come into contact with your skin or clothes promptly wash it off using soap and water.
- Do not apply excessive force to the display surface or the adjoining areas since this may cause the color tone to vary.
- The polarizer covering the display surface of the LCD module is soft and easily scratched. Handle this polarize carefully.
- To prevent destruction of the elements by static electricity, be careful to maintain an optimum work environment.
 - Be sure to ground the body when handling the LCD module.
 - Tools required for assembly, such as soldering irons, must be properly grounded.
 - To reduce the amount of static electricity generated, do not conduct assembly and other work under dry conditions.
 - The LCD module is coated with a film to protect the display surface. Exercise care when peeling off this protective film since static electricity may be generated.
- Storage precautions
When storing the LCD modules, avoid exposure to direct sunlight or to the light of fluorescent lamps. Keep the modules in bags designed to prevent static electricity charging under low temperature / normal humidity conditions (avoid high temperature / high humidity and low temperatures below 0°C).Whenever possible, the LCD modules should be stored in the same conditions in which they were shipped from our company.

17. Others

- Liquid crystals solidify at low temperature (below the storage temperature range) leading to defective orientation of liquid crystal or the generation of air bubbles (black or white). Air bubbles may also be generated if the module is subjected to a strong shock at a low temperature.
- If the LCD modules have been operating for a long time showing the same display patterns may remain on the screen as ghost images and a slight contrast irregularity may also appear. Abnormal operating status can be resumed to be normal condition by suspending use for some time. It should be noted that this phenomena does not adversely affect performance reliability.
- To minimize the performance degradation of the LCD modules resulting from caused by static electricity, etc. exercise care to avoid holding the following sections when handling the modules:
 - Exposed area of the printed circuit board
 - Terminal electrode sections