

SRM20256L_{10/12}

CMOS 256K-BIT STATIC RAM

DESCRIPTION

The SRM20256L_{10/12} is a 32,768 words x 8 bits asynchronous, static, random access memory fabricated using an advanced CMOS technology. Its very low standby power requirement makes it ideal for applications requiring non-volatile storage with back-up batteries. The asynchronous and static nature of the memory requires no external clock or refresh circuit. Input and output ports are TTL compatible and the three-state output allows easy expansion of memory capacity.

FEATURES

- Fast access time SRM20256L₁₀ 100ns (Max)
SRM20256L₁₂ 120ns (Max)
- Low supply current Standby : 2 μ A (Typ)
Operation: 13mA/1MHz (Typ)
- Completely static No clock required
- Single power supply 5V \pm 10%
- TTL compatible inputs and outputs
- 3-state output
- Battery back-up operation
- Package SRM20256LC_{10/12} 28-pin DIP(plastic)
SRM20256LM_{10/12} 28-pin SOP (plastic)
SRM20256LS_{10/12} 28-pin Shrink DIP (plastic)
SRM20256L_{10/12} 28-pin TSOP (plastic)

BLOCK DIAGRAM

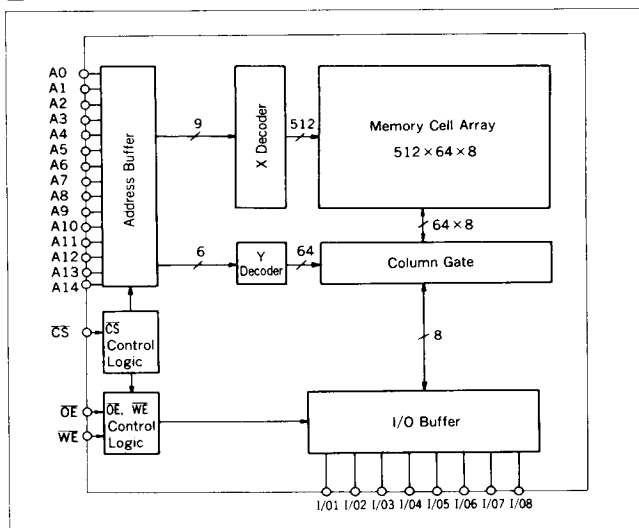

PIN CONFIGURATION

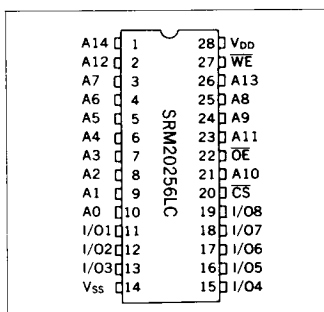

PIN DESCRIPTION

A0 to A14	Address Input
WE	Write Enable
OE	Output Enable
CS	Chip Select
I/01 to 8	Data Input/Output
V _{DD}	Power Supply (+5V)
V _{SS}	Power Supply (0V)

■ ABSOLUTE MAXIMUM RATINGS

(V_{SS} = 0V)

Parameter	Symbol	Ratings	Unit
Supply voltage	V _{DD}	-0.5 to 7.0	V
Input voltage	V _I	-0.5* to 7.0	V
Input/Output voltage	V _{I/O}	-0.5* to V _{DD} +0.3	V
Power dissipation	P _D	1.0	W
Operating temperature	T _{opr}	0 to 70	°C
Storage temperature	T _{stg}	-65 to 150	°C
Soldering temperature and time	T _{sol}	260°C, 10s (Lead only)	—

*V_I, V_{I/O}(Min) = -1.0V when pulse width is less or equal to 50ns

■ DC RECOMMENDED OPERATING CONDITIONS

(V_{SS} = 0V, T_a = 0 to 70°C)

Parameter	Symbol	Conditions	Min	Typ	Max	Unit
Supply voltage	V _{DD}		4.5	5.0	5.5	V
	V _{SS}		0	0	0	V
Input voltage	V _{IH}		2.2	3.5	V _{DD} +0.3	V
	V _{IL}		-0.3*	0	0.8	V

*V_{IL}(Min) = -1.0V when pulse width is less or equal to 50ns

■ ELECTRICAL CHARACTERISTICS

● DC Electrical Characteristics

(V_{DD} = 5V ± 10%, V_{SS} = 0V, T_a = 0 to 70°C)

Parameter	Symbol	Conditions	SRM20256LC ₁₀			SRM20256LC ₁₂			Unit
			Min	Typ*	Max	Min	Typ*	Max	
Input leakage	I _{LI}	V _I = 0 to V _{DD}	-1	—	1	-1	—	1	μA
Standby supply current	I _{DDs}	CS = V _{IH}	—	1.5	3.0	—	1.5	3.0	mA
	I _{DDs1}	CS ≥ V _{DD} - 0.2V	—	2	100	—	2	100	μA
Average operating current	I _{DDA}	V _I = V _{IL} , V _{IH} I _{I/O} = 0mA t _{cyc} = Min	—	40	70	—	37	70	mA
	I _{DDA1}	V _I = V _{IL} , V _{IH} I _{I/O} = 0mA t _{cyc} = 1μs	—	13	—	—	13	—	mA
Operating supply current	I _{DDO}	V _I = V _{IL} , V _{IH} I _{I/O} = 0mA	—	35	65	—	35	65	mA
Output leakage	I _{LO}	CS = V _{IH} or WE = V _{IL} or OE = V _{IH} V _{I/O} = 0 to V _{DD}	-1	—	1	-1	—	1	μA
High level output voltage	V _{OH}	I _{OH} = -1.0mA	2.4	V _{DD} -0.1	—	2.4	V _{DD} -0.1	—	V
Low level output voltage	V _{OL}	I _{OL} = 2.1mA	—	0.2	0.4	—	0.2	0.4	V

*Typical values are measured at T_a = 25°C and V_{DD} = 5.0V

● Terminal Capacitance

(f = 1MHz, T_a = 25°C)

Parameter	Symbol	Conditions	Min	Typ	Max	Unit
Address Capacitance	C _{ADD}	V _{ADD} = 0V	—	—	10	pF
Input Capacitance	C _I	V _I = 0V	—	—	10	pF
I/O Capacitance	C _{I/O}	V _{I/O} = 0V	—	—	10	pF

● AC Electrical Characteristics

○ Read Cycle

(V_{DD} = 5V ± 10%, V_{SS} = 0V, T_a = 0 to 70°C)

Parameter	Symbol	Conditions	SRM20256LC ₁₀		SRM20256LC ₁₂		Unit
			Min	Max	Min	Max	
Read cycle time	t _{RC}		100	—	120	—	ns
Address access time	t _{ACC}	*1	—	100	—	120	ns
CS access time	t _{ACS}		—	100	—	120	ns
OE access time	t _{OE}		—	50	—	60	ns
CS output set time	t _{CLZ}	*2	10	—	10	—	ns
CS output floating	t _{CHZ}		—	35	—	40	ns
OE output set time	t _{OLZ}		5	—	5	—	ns
OE output floating	t _{OHZ}		—	35	—	40	ns
Output hold time	t _{OH}	*1	10	—	10	—	ns

○ Write Cycle

($V_{DD} = 5V \pm 10\%$, $V_{SS} = 0V$, $T_a = 0$ to $70^\circ C$)

Parameter	Symbol	Conditions	SRM20256LC10		SRM20256LC12		Unit
			Min	Max	Min	Max	
Write cycle time	t_{wc}	* 1	100	—	120	—	ns
Chip select time	t_{cw}		80	—	85	—	ns
Address valid to end of write	t_{aw}		80	—	85	—	ns
Address setup time	t_{as}		0	—	0	—	ns
Write pulse width	t_{wp}		75	—	80	—	ns
Address hold time	t_{wr}		0	—	0	—	ns
Input data set time	t_{dw}		45	—	50	—	ns
Input data hold time	t_{dh}	0	—	0	—	ns	
Write to Output floating	t_{whz}	* 2	—	35	—	40	ns
Output Active from end of write	t_{ow}		10	—	10	—	ns

* 1 Test Conditions

1. Input pulse level : 0.6V to 2.4V
2. $t_r = t_f = 5ns$
3. Input and output timing reference levels : 1.5V
4. Output load $C_L = 100pF$

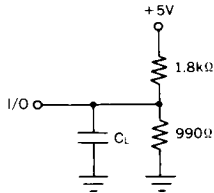

$C_L = 100pF$ (Includes Jig Capacitance)

* 2 Test Conditions

1. Input pulse level : 0.6V to 2.4V
2. $t_r = t_f = 5ns$
3. Input timing reference levels : 1.5V
4. Output timing reference levels : $\pm 200mV$ (the level displaced from stable output voltage level)
5. Output load $C_L = 5pF$

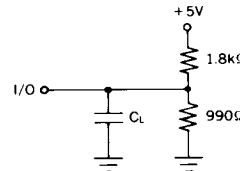

$C_L = 5pF$ (Includes Jig Capacitance)

● Timing Chart

○ Read Cycle

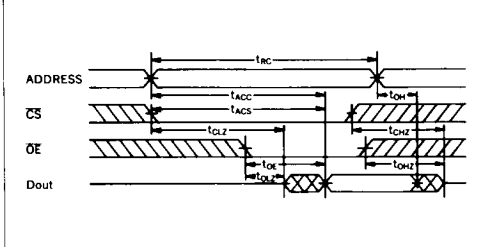

○ Write Cycle (CS Control)

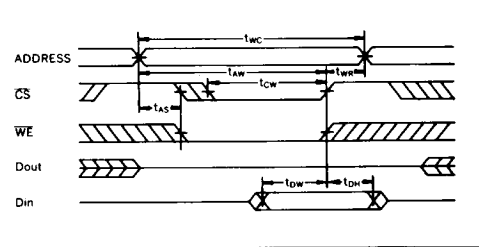

○ Write Cycle (2) (WE Control)

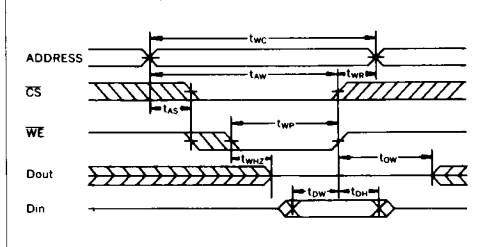

Note :

1. During read cycle time, \overline{WE} is to be "H" level.
2. During write cycle time that is controlled by \overline{CS} , Output Buffer is in high impedance state, whether \overline{OE} level is "H" or "L".
3. During write cycle time that is controlled by \overline{WE} , Output Buffer is in high impedance state if \overline{OE} is "H" level.

■ DATA RETENTION CHARACTERISTIC WITH LOW VOLTAGE POWER SUPPLY

(V_{SS}=0V, T_a=0 to 70°C)

Parameter	Symbol	Conditions	Min	Typ	Max	Unit
Data retention supply voltage	V _{DDR}		2.0	—	—	V
Data retention current	I _{DDR}	V _{DD} =3V, $\overline{CS} \geq V_{DDR} - 0.2V$	—	1	5.5	μA
Chip select data hold time	t _{CDR}		0	—	—	ns
Operation recovery time	t _R		t _{RC} *	—	—	ns

*t_{RC} = Read cycle time

Data retention timing

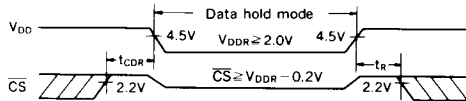

■ FUNCTIONS

● Truth Table

\overline{CS}	\overline{OE}	\overline{WE}	A0 to A14	DATA I/O	Mode	I _{DD}
H	—	—	—	Hi-Z	Standby	I _{DDs} , I _{DDs1}
L	X	L	Stable	D _{IN}	Write	I _{DDA} , I _{DDA1}
L	L	H	Stable	D _{OUT}	Read	I _{DDA} , I _{DDA1}
L	H	H	Stable	Hi-Z	Output disable	I _{DDA} , I _{DDA1}

● Read Mode

The Data appear when the address is setted while holding $\overline{CS} = "L"$, $\overline{OE} = "L"$ and $\overline{WE} = "H"$. When $\overline{OE} = "H"$, Data I/O terminals are in high impedance state, that makes circuit design and bus control easy.

● Write Mode

There are the following 3 ways of writing data into memory.

- (1) Hold $\overline{CS} = "L"$ and $\overline{WE} = "L"$, set address.
- (2) Hold $\overline{CS} = "L"$ then set address and give "L" pulse to \overline{WE} .
- (3) After setting addresses, give "L" pulse to both \overline{CS} and \overline{WE} .

In above any case data on the DATA I/O terminals are latched up into the SRM20256L10/12 when \overline{CS} or \overline{WE} is in positive-going. Since DATA I/O terminals are high impedance when \overline{CS} or $\overline{OE} = "H"$, bus contention between data driver and memory outputs can be avoided.

● Standby Mode

When \overline{CS} is "H" the SRM20256L10/12 become in the stand-by mode. In this mode, data I/O terminals are Hi-Z, and all inputs of addresses, \overline{WE} and data can be any "H" or "L". When \overline{CS} is over than V_{DD}-0.2V, the SRM20256L10/12 is in the data retention battery back-up mode, in this case, there is a small current in the SRM20256L10/12 which flow through the high resistances of the memory cells.

■ PACKAGE DIMENSIONS

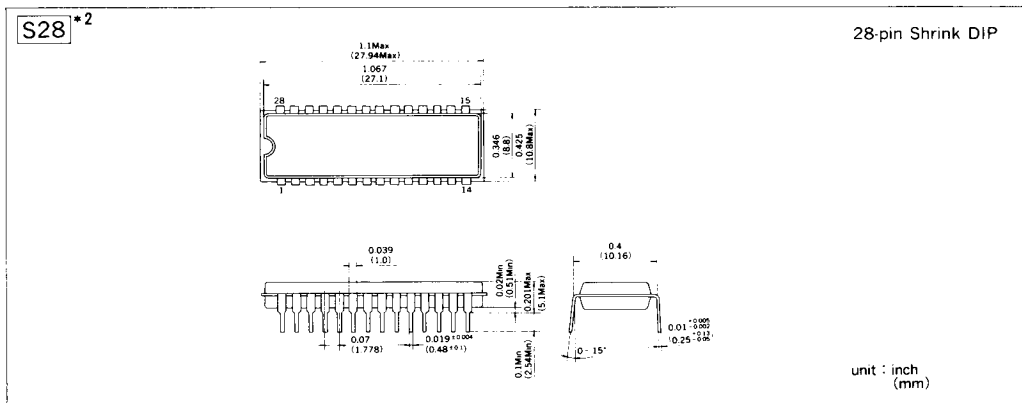
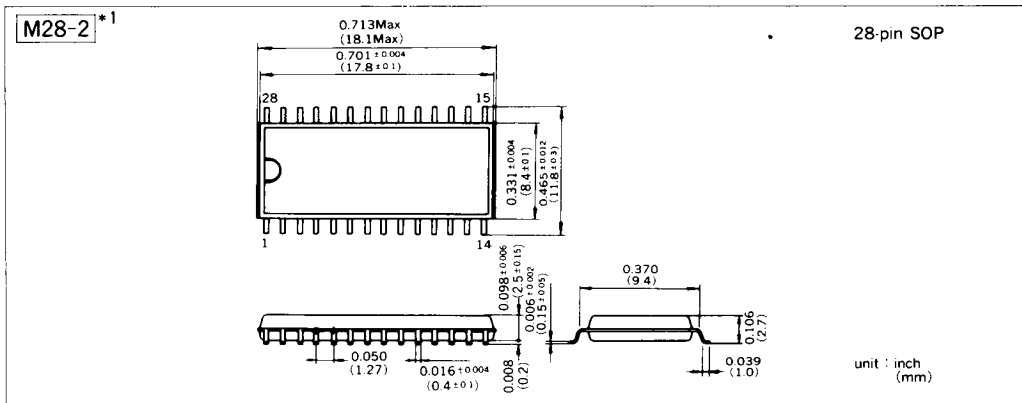
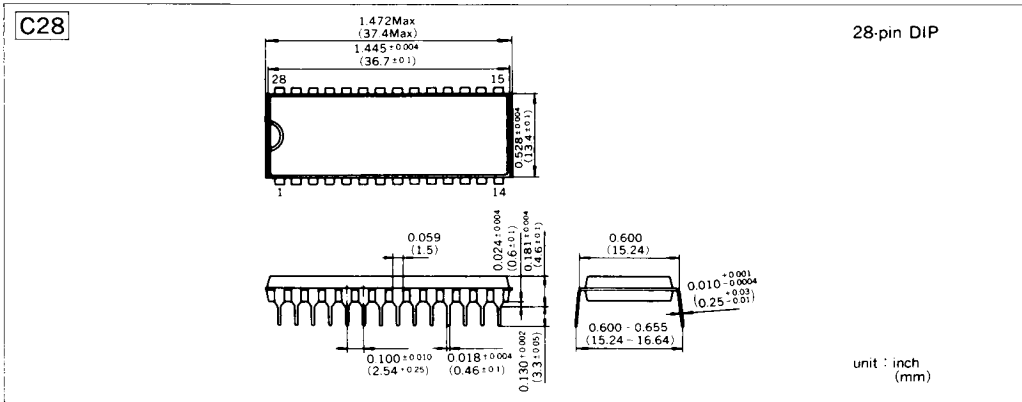

*1 Represents SRM20256LM_{10/12} that has the same electrical characteristics as SRM20256LC_{10/12}.
 *2 Represents SRM20256LS_{10/12} that has the same electrical characteristics as SRM20256LC_{10/12}.

PACKAGE DIMENSIONS

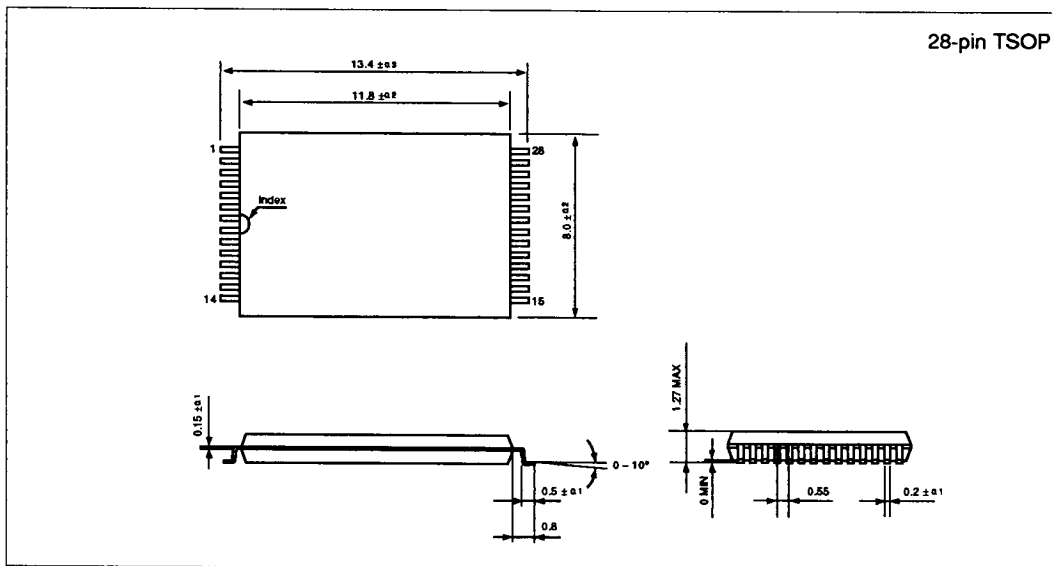

CHARACTERISTICS CURVES

