

Distributed by:

JAMECO[®]
ELECTRONICS

www.Jameco.com ♦ 1-800-831-4242

The content and copyrights of the attached
material are the property of its owner.

Jameco Part Number 43191



R650X and R651X Microprocessors (CPU)

DESCRIPTION

The 8-bit R6500 microprocessor devices are produced with N-channel, silicon gate technology. Performance speeds are enhanced by advanced system architecture. This innovative architecture results in smaller chips—the semiconductor threshold is cost-effectivity. System cost-effectivity is further enhanced by providing a family of 10 software-compatible microprocessor (CPU) devices, described in this document. Rockwell also provides single chip microcomputers, memory and peripheral devices—as well as low-cost design aids and documentation.

Ten CPU devices are available. All are software-compatible. They provide options of addressable memory, interrupt input, on-chip clock oscillators and drivers. All are bus-compatible with earlier generation microprocessors like the M6800 devices.

The R650X and R651X family includes six microprocessors with on-board clock oscillators and drivers and four microprocessors driven by external clocks. The on-chip clock versions are aimed at high performance, low cost applications where single phase inputs, crystal or RC inputs provide the time base. The external clock versions are geared for multiprocessor system applications where maximum timing control is mandatory. All R6500 microprocessors are also available in a variety of packaging (ceramic and plastic), operating frequency (1 MHz, 2 MHz and 3 MHz) and temperature (commercial and industrial) versions.

ORDERING INFORMATION

Part Number: R65XX	
Temperature Range (T_L to T_H):	
No letter = 0°C to +70°C	
E = -40°C to +85°C	
Package:	
C = Ceramic DIP	
P = Plastic DIP	
Frequency Range:	
No letter = 1 MHz	
A = 2 MHz	
B = 3 MHz	
Model Designator:	
XX = 02, 03, 04, ... 15	

FEATURES

- N-channel, silicon gate, depletion load technology
- 8-bit parallel processing
- 56 instructions
- Decimal and binary arithmetic
- Thirteen addressing modes
- True indexing capability
- Programmable stack pointer
- Variable length stack
- Interrupt request
- Non-maskable interrupt
- Use with any type of speed memory
- 8-bit bidirectional data bus
- Addressable memory range of up to 64K bytes
- "Ready" input
- Direct Memory Access capability
- Bus compatible with M6800
- 1 MHz, 2 MHz, and 3 MHz versions
- Choice of external or on-chip clocks
- On-chip clock options
 - External single clock input
 - Crystal time base input
- Commercial and industrial temperature versions
- Pipeline architecture
- Single +5V supply

2

R6500 CPU FAMILY MEMBERS

Microprocessors with Internal Two Phase Clock Generator

Model	No. Pins	Addressable Memory
R6502	40	64K Bytes
R6503	28	4K Bytes
R6504	28	8K Bytes
R6505	28	4K Bytes
R6506	28	4K Bytes
R6507	28	8K Bytes

Microprocessors with External Two Phase Clock Input

Model	No. Pins	Addressable Memory
R6512	40	64K Bytes
R6513	28	4K Bytes
R6514	28	8K Bytes
R6515	28	4K Bytes

7-49-17-06

R650X, R651X**R6500 Microprocessors (CPU)****INTERFACE SIGNAL DESCRIPTIONS****CLOCKS ($\phi 1$, $\phi 2$)**

The R651X requires a two phase non-overlapping clock that runs at the V_{CC} voltage level. The R650X clocks are supplied with an internal clock generator. The frequency of these clocks is externally controlled.

ADDRESS BUS (A0-A15)

The address line outputs access data in memory device locations or cells, access data in I/O device registers and/or effect logical operations in I/O or controller devices depending on system design. The addressing range is determined by the number of address lines available on the particular CPU device. The R6502 and R6512 can address 64K bytes with a 16-bit address bus (A0-A15); the R6504, R6507, and the R6514 can address 8K bytes with a 13-bit address bus (A0-A12); and the R6503, R6505, R6506, R6513, and R6515 can address 4K bytes with a 12-bit address bus (A0-A11). These outputs are TTL-compatible and are capable of driving one standard TTL load and 130 pF.

DATA BUS (D0-D7)

The data lines (D0-D7) form an 8-bit bidirectional data bus which transfers data between the CPU and memory or peripheral devices. The outputs are tri-state buffers capable of driving one standard TTL load and 130 pF.

DATA BUS ENABLE (DBE, R6512 ONLY)

The TTL-compatible DBE input allows external control of the tri-state data output buffers and will enable the microprocessor bus driver when in the high state. In normal operation DBE is driven by the phase two ($\phi 2$) clock, thus allowing data output from microprocessor only during $\phi 2$. During the read cycle, the data bus drivers are internally disabled, becoming essentially an open circuit. To disable data bus drivers externally, DBE should be held low.

READY (RDY)

The Ready input signal allows the user to halt or single cycle the microprocessor on all cycles except write cycles. A negative transition to the low state during or coincident with phase one ($\phi 1$) will halt the microprocessor with the output address lines reflecting the current address being fetched. If Ready is low during a write cycle, it is ignored until the following read operation. This condition will remain through a subsequent phase two ($\phi 2$) in which the Ready signal is low. This feature allows microprocessor interfacing with the low speed PROMs as well as Direct Memory Access (DMA).

INTERRUPT REQUEST (\overline{IRQ})

The TTL level active-low \overline{IRQ} input requests that an interrupt sequence begin within the microprocessor. The microprocessor will complete the current instruction being executed before recognizing the request. At that time, the interrupt mask bit in the Processor Status Register will be examined. If the interrupt mask flag is not set, the microprocessor will begin an interrupt sequence. The Program Counter and Processor Status Register

are stored in the stack. The microprocessor will then set the interrupt mask flag high so that no further interrupts can occur. At the end of this cycle, the program counter low will be loaded from address FFFE, and program counter high from location FFFF, therefore transferring program control to the memory vector located at these addresses. The RDY signal must be in the high state for any interrupt to be recognized. A 3K Ω external resistor should be used for proper wire-OR operation.

NON-MASKABLE INTERRUPT (\overline{NMI})

A negative going edge on the \overline{NMI} input requests that a non-maskable interrupt sequence be generated within the microprocessor.

\overline{NMI} is an unconditional interrupt. Following completion of the current instruction, the sequence of operations defined for \overline{IRQ} will be performed, regardless of the state interrupt mask flag. The vector address loaded into the program counter, low and high, are locations FFFA and FFFB respectively, thereby transferring program control to the memory vector located at these addresses. The instructions loaded at these locations cause the microprocessor to branch to a non-maskable interrupt routine in memory.

\overline{NMI} also requires an external 3K Ω register to V_{CC} for proper wire-OR operations.

Inputs \overline{IRQ} and \overline{NMI} are hardware interrupts lines that are sampled during $\phi 2$ (phase 2) and will begin the appropriate interrupt routine on the $\phi 1$ (phase 1) following the completion of the current instruction.

SET OVERFLOW FLAG (\overline{SO})

A negative going edge on the \overline{SO} input sets the overflow bit in the Processor Status Register. This signal is sampled on the trailing edge of $\phi 1$ and must be externally synchronized.

SYNC

The SYNC output line identifies those cycles in which the microprocessor is doing an OP CODE fetch. The SYNC line goes high during $\phi 1$ of an OP CODE fetch and stays high for the remainder of that cycle. If the RDY line is pulled low during the $\phi 1$ clock pulse in which SYNC went high, the processor will stop in its current state and will remain in the state until the RDY line goes high. In this manner, the SYNC signal can be used to control RDY to cause single instruction execution.

RESET (\overline{RES})

The active low \overline{RES} resets, or starts, the microprocessor from a power down or restart condition. During the time that this line is held low, writing to or from the microprocessor is inhibited. When a positive edge is detected on the input, the microprocessor will immediately begin the reset sequence.

After a system initialization time of six clock cycles, the mask interrupt flag is set and the microprocessor loads the program counter from the memory vector locations FFFC and FFFD. This is the start location for program control.

After V_{CC} reaches 4.75 volts in a power up routine, reset must be held low for at least two clock cycles. At this time the R/W and SYNC signals become valid.

R650X, R651X

R6500 Microprocessors (CPU)

T-49-17-06

2

<p>R6502 FEATURES</p> <ul style="list-style-type: none"> • 64K addressable bytes of memory (A0-A15) • On-chip clock TTL-level single phase input RC time base input crystal time base input • Two phase output clock for timing of support chips • $\overline{\text{IRQ}}$ interrupt • $\overline{\text{NMI}}$ interrupt • RDY signal • SYNC signal (can be used for single instruction execution) • 40-pin DIP 	
<p>R6503 FEATURES</p> <ul style="list-style-type: none"> • 4K addressable bytes of memory (A0-A11) • On-chip clock • $\overline{\text{IRQ}}$ interrupt • $\overline{\text{NMI}}$ interrupt • 28-pin DIP 	
<p>R6504 FEATURES</p> <ul style="list-style-type: none"> • 8K addressable bytes of memory (A0-A12) • On-chip clock • $\overline{\text{IRQ}}$ interrupt • 28-pin DIP 	
<p>R6505 FEATURES</p> <ul style="list-style-type: none"> • 4K addressable bytes of memory (A0-A11) • On-chip clock • $\overline{\text{IRQ}}$ interrupt • RDY signal • 28-pin DIP 	

R650X, R651X

R6500 Microprocessors (CPU)

T-49-17-06

R6506 FEATURES

- 4K addressable bytes of memory (A0-A11)
- On-chip clock
- Two phase output clock for timing of support chips
- $\overline{\text{IRQ}}$ interrupt
- 28-pin DIP

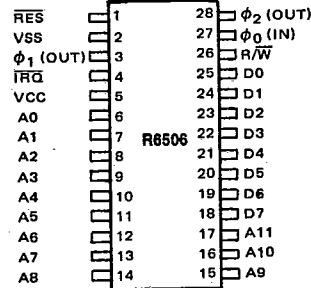

R6507 FEATURES

- 8K addressable bytes of memory (A0-A12)
- On-chip clock
- RDY signal
- 28-pin DIP

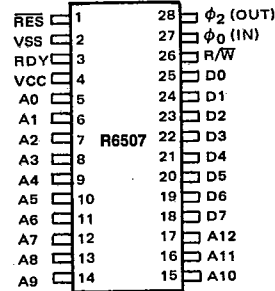

R6512 FEATURES

- 64K addressable bytes of memory (A0-A15)
- Two phase clock input
- $\overline{\text{IRQ}}$ interrupt
- $\overline{\text{NMI}}$ interrupt
- RDY signal
- SYNC signal
- Data Bus Enable
- 40-pin DIP

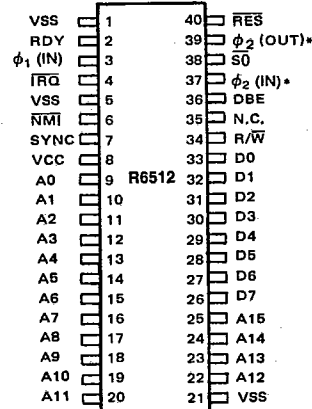

*Pins 37 and 39 are connected internally

R650X, R651X

R6500 Microprocessors (CPU)

T-49-17-06

2

R6513 FEATURES

- 4K addressable bytes of memory (A0-A11)
- Two phase clock input
- $\overline{\text{IRQ}}$ interrupt
- $\overline{\text{NMI}}$ interrupt
- 28-pin DIP

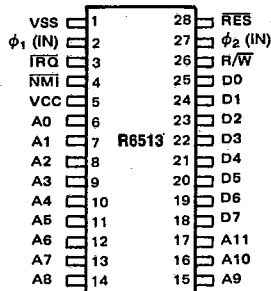

R6514 FEATURES

- 8K addressable bytes of memory (A0-A12)
- Two phase clock input
- $\overline{\text{IRQ}}$ interrupt
- 28-pin DIP

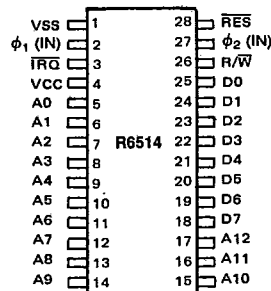

R6515 FEATURES

- 4K addressable bytes of memory (A0-A11)
- Two phase clock input
- $\overline{\text{IRQ}}$ interrupt
- RDY signal
- 28-pin DIP

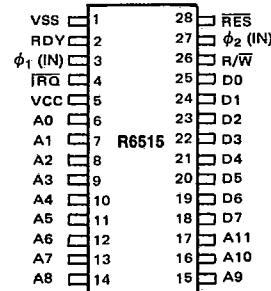

R650X, R651X**R6500 Microprocessors (CPU)**

7-49-17-06

FUNCTIONAL DESCRIPTION

The internal organization of all R6500 CPUs is identical except for some variations in clock interface, the number of address output lines, and some unique input/output lines between versions.

CLOCK GENERATOR

The clock generator develops all internal clock signals, and (where applicable) external clock signals, associated with the device. It is the clock generator that drives the timing control unit and the external timing for slave mode operations.

TIMING CONTROL

The timing control unit keeps track of the instruction cycle being monitored. The unit is set to zero each time an instruction fetch is executed and is advanced at the beginning of each phase one clock pulse for as many cycles as is required to complete the instruction. Each data transfer which takes place between the registers depends upon decoding the contents of both the instruction register and the timing control unit.

PROGRAM COUNTER

The 16-bit program counter provides the addresses which step the microprocessor through sequential instructions in a program.

Each time the microprocessor fetches an instruction from program memory, the lower byte of the program counter (PCL) is placed on the low-order bits of the address bus and the higher byte of the program counter (PCH) is placed on the high-order 8 bits. The counter is incremented each time an instruction or data is fetched from program memory.

INSTRUCTION REGISTER AND DECODE

Instructions fetched from memory are gated onto the internal data bus. These instructions are latched into the instruction register, then decoded, along with timing and interrupt signals, to generate control signals for the various registers.

ARITHMETIC AND LOGIC UNIT (ALU)

All arithmetic and logic operations take place in the ALU including incrementing and decrementing internal registers (except the program counter). The ALU has no internal memory and is used only to perform logical and transient numerical operations.

ACCUMULATOR

The accumulator is a general purpose 8-bit register that stores the results of most arithmetic and logic operations, and in addition, the accumulator usually contains one of the two data words used in these operations.

INDEX REGISTERS

There are two 8-bit index registers (X and Y), which may be used to count program steps or to provide an index value to be used in generating an effective address.

When executing an instruction which specifies indexed addressing, the CPU fetches the op code and the base address, and modifies the address by adding the index register to it prior to performing the desired operation. Pre- or post-indexing of indirect addresses is possible (see addressing modes).

STACK POINTER

The stack pointer is an 8-bit register used to control the addressing of the variable-length stack on page one. The stack pointer is automatically incremented and decremented under control of the microprocessor to perform stack manipulations under direction of either the program or interrupts (NMI) and (IRQ). The stack allows simple implementation of nested subroutines and multiple level interrupts. The stack pointer should be initialized before any interrupts or stack operations occur.

PROCESSOR STATUS REGISTER

The 8-bit processor status register contains seven status flags. Some of the flags are controlled by the program, others may be controlled both by the program and the CPU.

R650X, R651X

R6500 Microprocessors (CPU)

T-49-17-06

2

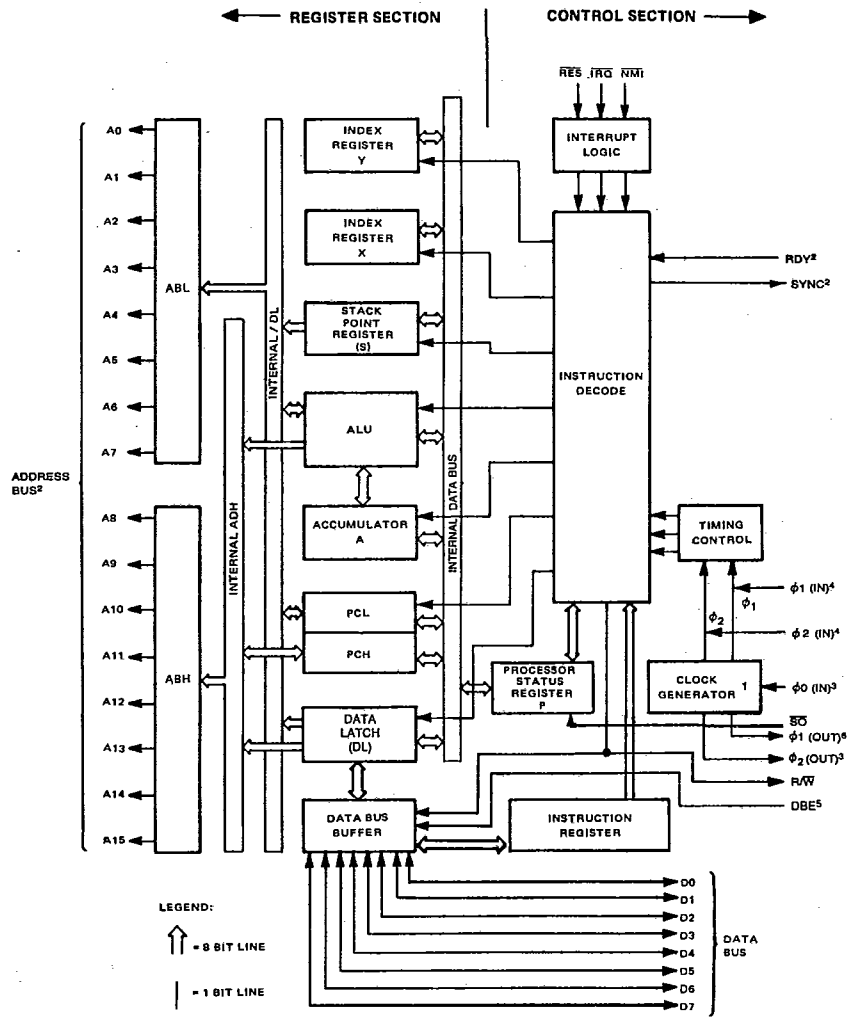

- NOTE**
1. CLOCK GENERATOR IS NOT INCLUDED ON R6512, R6513, R6514 AND R6515.
 2. ADDRESSING CAPABILITY AND CONTROL OPTIONS VARY WITH EACH OF THE CPUs.
 3. R6502, R6503, R6504, R6505, R6506 AND R6507.
 4. R6512, R6513, R6514 AND R6515.
 5. R6512 ONLY.
 6. R6502 AND R6506.

R650X and R651X Internal Architecture

T-49-17-06

R650X, R651X

R6500 Microprocessors (CPU)

INSTRUCTION SET

The R6500 CPU has 56 instruction types which are enhanced by up to 13 addressing modes for each instruction. The

Accumulator, index registers, Program Counter, Stack Pointer and Processor Status Register are illustrated below.

Alphabetic Listing of Instruction Set

Mnemonic	Function	Mnemonic	Function
ADC	Add Memory to Accumulator with Carry	JMP	Jump to New Location
AND	"AND" Memory with Accumulator	JSR	Jump to New Location Saving Return Address
ASL	Shift Left One Bit (Memory or Accumulator)	LDA	Load Accumulator with Memory
BCC	Branch on Carry Clear	LDX	Load Index X with Memory
BCS	Branch on Carry Set	LDY	Load Index Y with Memory
BEQ	Branch on Result Zero	LSR	Shift One Bit Right (Memory or Accumulator)
BIT	Test Bits in Memory with Accumulator	NOB	No Operation
BMI	Branch on Result Minus	ORA	"OR" Memory with Accumulator
BNE	Branch on Result not Zero	PHA	Push Accumulator on Stack
BPL	Branch on Result Plus	PHP	Push Processor Status on Stack
BRK	Force Break	PLA	Pull Accumulator from Stack
BVC	Branch on Overflow Clear	PLP	Pull Processor Status from Stack
BVS	Branch on Overflow Set	ROL	Rotate One Bit Left (Memory or Accumulator)
CLC	Clear Carry Flag	ROR	Rotate One Bit Right (Memory or Accumulator)
CLD	Clear Decimal Mode	RTI	Return from Interrupt
CLI	Clear Interrupt Disable Bit	RTS	Return from Subroutine
CLV	Clear Overflow Flag	SBC	Subtract Memory from Accumulator with Borrow
CMP	Compare Memory and Accumulator	SEC	Set Carry Flag
CPX	Compare Memory and Index X	SED	Set Decimal Mode
CPY	Compare Memory and Index Y	SEI	Set Interrupt Disable Status
DEC	Decrement Memory by One	STA	Store Accumulator in Memory
DEX	Decrement Index X by One	STX	Store Index X in Memory
DEY	Decrement Index Y by One	STY	Store Index Y in Memory
EOR	"Exclusive-OR" Memory with Accumulator	TAX	Transfer Accumulator to Index X
INC	Increment Memory by One	TAY	Transfer Accumulator to Index Y
INX	Increment Index X by One	TSX	Transfer Stack Pointer to Index X
INY	Increment Index Y by One	TXA	Transfer Index X to Accumulator
		TXS	Transfer Index X to Stack Register
		TYA	Transfer Index Y to Accumulator

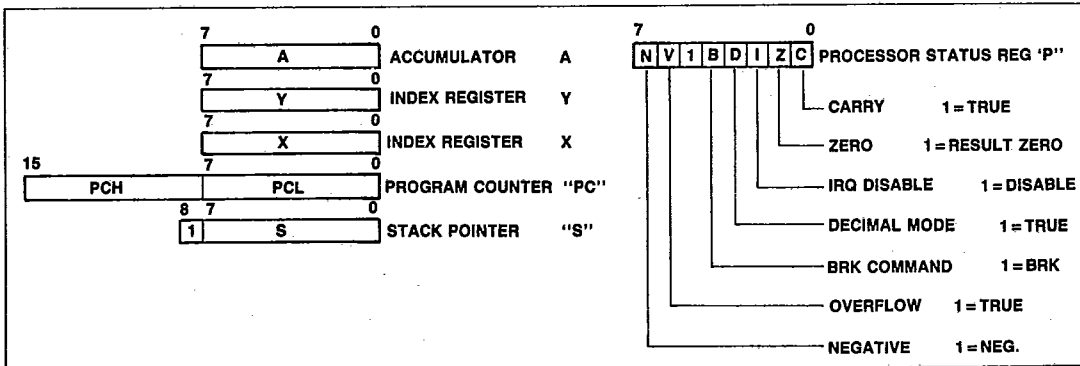

Programming Model

7-49-17-06

R650X, R651X**R6500 Microprocessor (CPU)****ADDRESSING MODES**

The R6500 CPU family has 13 addressing modes. In the following discussion of these addressing modes, a bracketed expression follows the title of the mode. This expression is the term used in the Instruction Set Op Code Matrix table (later in this product description) to make it easier to identify the actual addressing mode used by the instruction.

ACCUMULATOR ADDRESSING [Accum]—This form of addressing is represented with a one byte instruction, implying an operation on the accumulator.

IMMEDIATE ADDRESS [IMM]—In immediate addressing, the second byte of the instruction contains the operand, with no further memory addressing required.

ABSOLUTE ADDRESSING [Absolute]—In absolute addressing, the second byte of the instruction specifies the eight low order bits of the effective address while the third byte specifies the eight high order bits. Thus, the absolute addressing mode allows access to the entire 64K bytes of addressable memory.

ZERO PAGE ADDRESSING [ZP]—The zero page instructions allow for shorter code and execution times by fetching only the second byte of the instruction and assuming a zero high address byte. Careful use of the zero page can result in significant increase in code efficiency.

INDEXED ZERO PAGE ADDRESSING [ZP, X or Y]—This form of addressing is used with the index register and is referred to as "Zero Page, X" or "Zero Page, Y". The effective address is calculated by adding the second byte to the contents of the index register. Since this is a form of "Zero Page" addressing, the content of the second byte references a location in page zero. Additionally, due to the "Zero Page" addressing nature of this mode, no carry is added to the high order eight bits of memory and crossing of page boundaries does not occur.

INDEXED ABSOLUTE ADDRESSING [ABS, X or Y]—This form of addressing is used in conjunction with X and Y index register and is referred to as "Absolute, X" and "Absolute, Y." The effective address is formed by adding the contents of X or Y to the address contained in the second and third bytes of the instruction. This mode allows the index register to contain the index or count value and the instruction to contain the base

address. This type of indexing allows referencing of any location and the index may modify multiple fields, resulting in reduced coding and execution time.

IMPLIED ADDRESSING [Implied]—In the implied addressing mode, the address containing the operand is implicitly stated in the operation code of the instruction.

RELATIVE ADDRESSING [Relative]—Relative addressing is used only with branch instructions and establishes a destination for the conditional branch.

The second byte of the instruction is an operand. This operand is an offset which is added to the program counter when the counter is set at the next instruction. The range of the offset is -128 to +127 bytes.

INDEXED INDIRECT ADDRESSING [(IND, X)]—In indexed indirect addressing (referred to as (Indirect, X)), the second byte of the instruction is added to the contents of index register X discarding the carry. The result of this addition points to a memory location on page zero which contains the low order byte of the effective address. The next memory location in page zero contains the high order byte of the effective address. Both memory locations specifying the effective address must be in page zero.

INDIRECT INDEXED ADDRESSING [(IND), Y]—In indirect indexed addressing (referred to as (Indirect), Y), the second byte of the instruction points to a memory location in page zero. The contents of this memory location are added to the contents of index register Y. The result is the low order byte of the effective address. The carry from this addition is added to the contents of the next page zero memory location, to form the high order byte of the effective address.

ABSOLUTE INDIRECT [Indirect]—The second byte of the instruction contains the low order byte of a memory location. The high order eight bits of that memory location are contained in the third byte of the instruction. The contents of the fully specified memory location are the low order byte of the effective address. The next memory location contains the high order byte of the effective address which is loaded into the sixteen bits of the program counter. (JMP (IND) only)

2

R650X, R651X

R6500 Microprocessors (CPU)

T-49-17-06

INSTRUCTION SET OP CODE MATRIX

The following matrix shows the Op Codes associated with the R6500 family of CPU devices. The matrix identifies the hexadecimal code, the mnemonic code, the addressing mode, the

number of instruction bytes, and the number of machine cycles associated with each Op Code. Also, refer to the instruction set summary for additional information on these Op Codes.

MSD	LSD															
	0	1	2	3	4	5	6	7	8	9	A	B	C	D	E	F
0	BRK Implied 1 7	ORA (IND, X) 2 6				ORA ZP 2 3	ASL ZP 2 5		PHP Implied 1 3	ORA IMM 2 2	ASL Accum 1 2			ORA ABS 3 4	ASL ABS 3 6	
1	BPL Relative 2 2**	ORA (IND), Y 2 5*				ORA ZP, X 2 4	ASL ZP, X 2 6		CLC Implied 1 2	ORA ABS, Y 3 4*				ORA ABS, X 3 4*	ASL ABS, X 3 7	
2	JSR Absolute 3 6	AND (IND, X) 2 6			BIT ZP 2, 3	AND ZP 2 3	ROL ZP 2 5		PLP Implied 1 4	AND IMM 2 2	ROL Accum 1 2		BIT ABS 3 4	AND ABS 3 4	ROL ABS 3 6	
3	BMI Relative 2 2**	AND (IND), Y 2 5*				AND ZP, X 2 4	ROL ZP, X 2 6		SEC Implied 1 2	AND ABS, Y 3 4*				AND ABS, X 3 4*	ROL ABS, X 3 7	
4	RTI Implied 1 6	EOR (IND, X) 2 6				EOR ZP 2 3	LSR ZP 2 5		PHA Implied 1 3	EOR IMM 2 2	LSR Accum 1 2		JMP ABS 3 3	EOR ABS 3 4	LSR ABS 3 6	
5	BVC Relative 2 2**	EOR (IND), Y 2 5*				EOR ZP, X 2 4	LSR ZP, X 2 6		CLI Implied 1 2	EOR ABS, Y 3 4*				EOR ABS, X 3 4*	LSR ABS, X 3 7	
6	RTS Implied 1 6	ADC (IND, X) 2 6				ADC ZP 2 3	ROR ZP 2 5		PLA Implied 1 4	ADC IMM 2 2	ROR Accum 1 2		JMP Indirect 3 5	ADC ABS 3 4	ROR ABS 3 6	
7	BVS Relative 2 2**	ADC (IND), Y 2 5*				ADC ZP, X 2 4	ROR ZP, X 2 6		SEI Implied 1 2	ADC ABS, Y 3 4*				ADC ABS, X 3 4*	ROR ABS, X 3 7	
8		STA (IND, X) 2 6			STY ZP 2 3	STA ZP 2 3	STX ZP 2 3		DEY Implied 1 2		TXA Implied 1 2		STY ABS 3 4	STA ABS 3 4	STX ABS 3 4	
9	BCC Relative 2 2**	STA (IND), Y 2 6			STY ZP, X 2 4	STA ZP, X 2 4	STX ZP, Y 2 4		TYA Implied 1 2	STA ABS, Y 3 5	TXS Implied 1 2			STA ABS, X 3 5		
A	LDY IMM 2 2	LDA (IND, X) 2 6	LDX IMM 2 2		LDY ZP 2 3	LDA ZP 2 3	LDX ZP 2 3		TAY Implied 1 2	LDA IMM 2 2	TAX Implied 1 2		LDY ABS 3 4	LDA ABS 3 4	LDX ABS 3 4	
B	BCS Relative 2 2**	LDA (IND), Y 2 5*			LDY ZP, X 2 4	LDA ZP, X 2 4	LDX ZP, Y 2 4		CLV Implied 1 2	LDA ABS, Y 3 4*	TSX Implied 1 2		LDY ABS, X 3 4*	LDA ABS, X 3 4*	LDX ABS, Y 3 4*	
C	CPY IMM 2 2	CMP (IND, X) 2 6			CPY ZP 2 3	CMP ZP 2 3	DEC ZP 2 5		INY Implied 1 2	CMP IMM 2 2	DEX Implied 1 2		CPY ABS 3 4	CMP ABS 3 4	DEC ABS 3 6	
D	BNE Relative 2 2**	CMP (IND), Y 2 5*				CMP ZP, X 2 4	DEC ZP, X 2 6		CLD Implied 1 2	CMP ABS, Y 3 4*				CMP ABS, X 3 4*	DEC ABS, X 3 7	
E	CPX IMM 2 2	SBC (IND, X) 2 6			CPX ZP 2 3	SBC ZP 2 3	INC ZP 2 5		INX Implied 1 2	SBC IMM 2 2	NOP Implied 1 2		CPX ABS 3 4	SBC ABS 3 4	INC ABS 3 6	
F	BEQ Relative 2 2**	SBC (IND), Y 2 5*				SBC ZP, X 2 4	INC ZP, X 2 6		SED Implied 1 2	SBC ABS, Y 3 4*				SBC ABS, X 3 4*	INC ABS, X 3 7	

0

BRK	—OP Code
Implied	—Addressing Mode
1 7	—Instruction Bytes; Machine Cycles

*Add 1 to N if page boundary is crossed.
 **Add 1 to N if branch occurs to same page;
 add 2 to N if branch occurs to different page.

R650X, R651X

R6500 Microprocessors (CPU)

T-49-17-06

R650X CLOCK TIMING

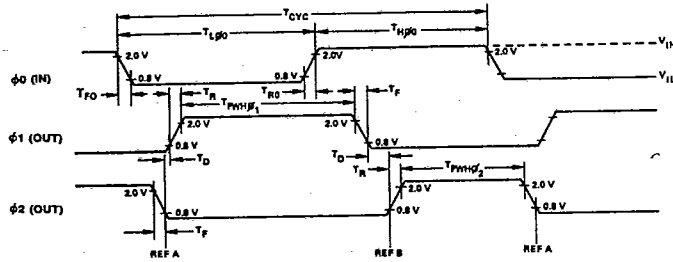

R651X CLOCK TIMING

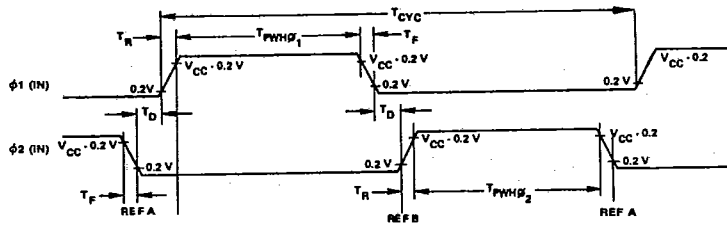

R65XX READ WRITE TIMING

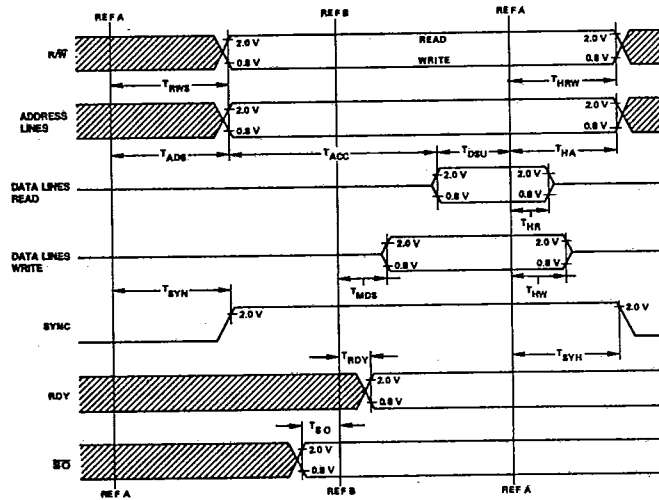

T-49-17-06

R650X, R651X

R6500 Microprocessors (CPU)

AC CHARACTERISTICS

Characteristic	Symbol	R65XX (1 MHz)		R65XXA (2 MHz)		R65XXB (3 MHz)		Unit
		Min	Max	Min	Max	Min	Max	

R650X CLOCK TIMING

Clock Cycle Time	T _{CYC}	1.0	10	0.5	10	0.33	10	μs
φ0 (IN) Low Pulse Width	T _{Lφ0}	480	—	240	—	160	—	ns
φ0 (IN) High Pulse Width	T _{Hφ0}	480	—	240	—	160	—	ns
φ0 (IN) Rise and Fall Time ^{1, 2}	T _{RO, TFO}	—	10	—	10	—	10	ns
φ1 (OUT) High Pulse Width	T _{PWHφ1}	460	—	235	—	155	—	ns
φ2 (OUT) High Pulse Width	T _{PWHφ2}	460	—	240	—	160	—	ns
Delay Between φ1 (OUT) and φ2 (OUT)	T _D	0	—	0	—	0	—	ns
φ1 (OUT), φ2 (OUT) Rise and Fall Time ^{1, 2}	T _{R, T_F}	—	25	—	25	—	15	ns

R651X CLOCK TIMING

Clock Cycle Time	T _{CYC}	1.0	10	0.5	10	0.33	10	μs
φ1 (IN) High Pulse Width	T _{PWHφ1}	430	—	215	—	150	—	ns
φ2 (IN) High Pulse Width	T _{PWHφ2}	470	—	235	—	160	—	ns
Delay Between φ1 and φ2	T _D	0	—	0	—	0	—	ns
φ1 (IN), φ2 (IN) Rise and Fall Time ^{1, 3}	T _{R, T_F}	—	25	—	20	—	15	ns

R65XX READ/WRITE TIMING

R/W Setup Time	T _{RWS}	—	225	—	140	—	110	ns
R/W Hold Time	T _{HRW}	30	—	30	—	15	—	ns
Address Setup Time	T _{ADS}	—	225	—	140	—	110	ns
Address Hold Time	T _{HA}	30	—	30	—	15	—	ns
Read Access Time	T _{ACC}	—	650	—	310	—	170	ns
Read Data Setup Time	T _{DSU}	100	—	50	—	50	—	ns
Read Data Hold Time	T _{HR}	10	—	10	—	10	—	ns
Write Data Setup Time	T _{MDS}	—	175	—	100	—	85	ns
Write Data Hold Time	T _{HW}	30	—	30	—	15	—	ns
SYNC Hold Time	T _{SYH}	30	—	30	—	15	—	ns
RDY Setup Time	T _{RDY}	100	—	50	—	35	—	ns
SO Setup Time	T _{SO}	100	—	50	—	35	—	ns
SYNC Setup Time	T _{SYN}	—	225	—	140	—	110	ns

Notes:

1. Loads: All output except clocks = 1 TTL + 130 pF. Clock outputs = 1 TTL + 30 pF.
2. Measured between 0.8 and 2.0 points on waveform load.
3. Measured between 10% and 90% points on waveforms.
4. *RDY must never switch states within T_{RDY} to end of φ2.

2

R650X, R651X

R6500 Microprocessors (CPU)

T-49-17-06

EXAMPLE OF TIME BASE GENERATION FOR R6502

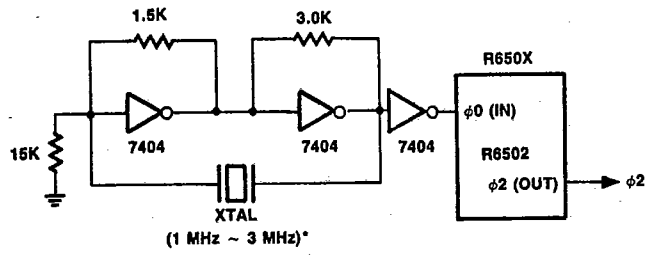

*CRYSTAL: CTS KNIGHTS MP SERIES, OR EQUIVALENT

R650X, R651X

R6500 Microprocessor (CPU)

T-49-17-06

ABSOLUTE MAXIMUM RATINGS*

Parameter	Symbol	Value	Unit
Supply Voltage	V _{CC}	-0.3 to +7.0	Vdc
Input Voltage	V _{IN}	-0.3 to +7.0	Vdc
Operating Temperature Range Commercial Industrial	T _A	-40 to +85	°C
Storage Temperature	T _{STG}	-55 to +150	°C

*NOTE: Stresses above those listed may cause permanent damage to the device. This is a stress rating only and functional operation of the device at these or any other conditions above those indicated in the other sections of this document is not implied. Exposure to absolute maximum rating conditions for extended periods may affect device reliability.

OPERATING CONDITIONS

Parameter	Symbol	Value
Supply Voltage	V _{CC}	5V ±5%
Temperature Range Commercial Industrial	T _A	0°C to +70°C -40°C to +85°C

DC CHARACTERISTICS

(V_{CC} = 5.0V ±5%, V_{SS} = 0; T_A = T_L to T_H, unless otherwise noted)

Parameter	Symbol	Min.	Typ. ⁵	Max.	Unit ¹	Test Conditions
Input High Voltage Logic Ø0 (IN) Ø1 (IN), Ø2 (IN)	V _{IH}	2.0 2.4 V _{CC} - 0.3	— — —	V _{CC} V _{CC} V _{CC} + 0.25	V	
Input Low Voltage Logic Ø0 (IN), Ø1 (IN), Ø2 (IN)	V _{IL}	-0.3 -0.3	— —	0.8 0.4	V	
Input Leakage Current Logic (Excl. RDY, SO) Ø1 (IN), Ø2 (IN) Ø0 (IN)	I _{IN}	— — —	— — —	2.5 100 10	µA	V _{IN} = 0V to 5.25V V _C = 0V
Input Leakage Current for Three State Off D0-D7	I _{TSI}	—	—	10	µA	V _{IN} = 0.4V to 2.4V V _{CC} = 5.25V
Output High Voltage SYNC, D0-D7, A0-A15, R _W , Ø1 (OUT), Ø2 (OUT)	V _{OH}	+2.4	—	—	V	I _{LOAD} = -100 µA V _{CC} = 4.75V
Output Low Voltage SYNC, D0-D7, A0-A15, R _W , Ø1 (OUT), Ø2 (OUT)	V _{OL}	—	—	+0.4	V	I _{LOAD} = 1.6 ma V _{CC} = 4.75V
Power Dissipation 1 and 2 MHz 3 MHz	P _D	— —	450 500	700 800	mW	
Capacitance Logic D0-D7 A0-A15, R _W , SYNC Ø0 (IN) Ø1 (IN) Ø2 (IN)	C C _{IN} C _{OUT} C _{Ø(IN)} C _{Ø1} C _{Ø2}	— — — — — —	— — — — 30 50	10 15 — 15 50 80	pF	V _{CC} = 5.0V V _{IN} = 0V f = 1 MHz T _A = 25°C

Notes:

- All units are direct current (dc) except for capacitance.
- Negative sign indicates outward current flow, positive indicates inward flow.
- IRQ and NMI require 3K pull-up resistor.
- Ø1 (IN) and Ø2 (IN) apply to R6512, 13, 14, and 15; Ø0 (IN) applies to R6502, 03, 04, 05, 06 and 07.
- Typical values shown for V_{CC} = 5.0V and T_A = 25°C.

2