

INTELLIGENT POWER LOW SIDE SWITCH

Features

- Over temperature shutdown
- Over current shutdown
- Active clamp
- Low current & logic level input
- ESD protection
- Optimized Turn On/Off for EMI
- Diagnostic on the input current

Description

The IPS2041(R)(L)PbF is a three terminal Intelligent Power Switch (IPS) that features a low side MOSFET with over-current, over-temperature, ESD protection and drain to source active clamp. This device offers protections and the high reliability required in harsh environments. The switch provides efficient protection by turning OFF the power MOSFET when the temperature exceeds 165°C or when the drain current reaches 5A. The device restarts once the input is cycled. A serial resistance connected to the input provides the diagnostic. The avalanche capability is significantly enhanced by the active clamp and covers most inductive load demagnetizations.

Product Summary

Rds(on)	130mΩ (max.)
Vclamp	68V
Ishutdown	5A (typ.)

Packages

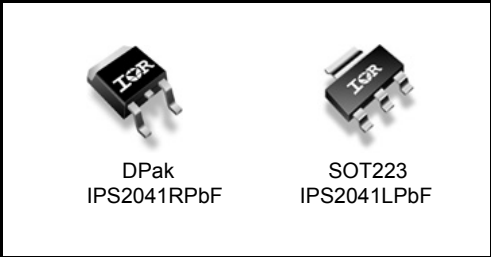

Typical Connection

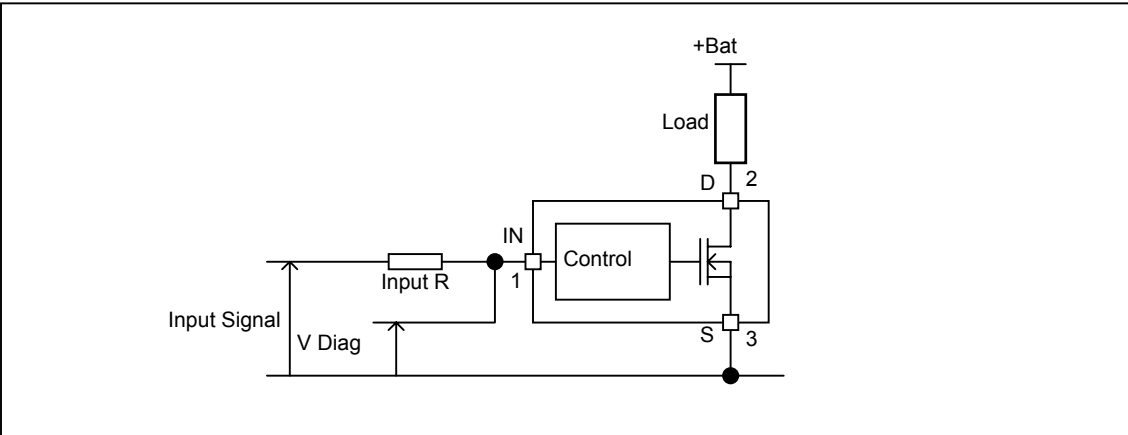

Absolute Maximum Ratings

Absolute maximum ratings indicate sustained limits beyond which damage to the device may occur. All voltage parameters are referenced to Ground lead. (Tambient=25°C unless otherwise specified).

Symbol	Parameter	Min.	Max.	Units
Vds	Maximum drain to source voltage	-0.3	60	V
Vds cont.	Maximum continuous drain to source voltage	-	35	V
Vin	Maximum input voltage	-0.3	6	V
Isd cont.	Max diode continuous current (limited by thermal dissipation) Rth=125°C/W	—	1.4	A
Pd	Maximum power dissipation (internally limited by thermal protection) Rth=125°C/W	—	1	W
ESD	Electrostatic discharge voltage (Human body) C=100pF, R=1500Ω Between drain and source	—	4	kV
	Other combinations	—	3	
	Electrostatic discharge voltage (Machine Model) C=200pF, R=0Ω Between drain and source	—	0.5	
	Other combinations	—	0.3	
Tj max.	Max. storage & operating temperature junction temperature	-40	150	°C

Thermal Characteristics

Symbol	Parameter	Typ.	Max.	Units
Rth1	Thermal resistance junction to ambient IPS2041L	100	—	°C/W
Rth2	Thermal resistance junction to ambient with 1" square footprint	50	—	
Rth1	Thermal resistance junction to ambient IPS2041R D-Pak std. footprint	70	—	
Rth2	Thermal resistance junction to ambient IPS2041R D-Pak 1" sq. footprint	50	—	
Rth3	Thermal resistance junction to case IPS2041R D-Pak	4	—	

Recommended Operating Conditions

These values are given for a quick design. For operation outside these conditions, please consult the application notes.

Symbol	Parameter	Min.	Max.	Units
VIH	High level input voltage	4	5.5	
VIL	Low level input voltage	0	0.5	
Ids	Continuous drain current, Tambient=85°C, Tj=125°C, Vin=5V, Rth=100°C/W	—	1.4	A
Rin	Recommended resistor in series with IN pin to generate a diagnostic	0.5	5	kΩ
Max L	Max recommended load inductance (including line inductance) (1)	—	10	mH
Max. t rise	Max. input rising time	—	1	µs

(1) Higher inductance is possible if maximum load current is limited - see figure 11

Static Electrical Characteristics

T_J=25°C, V_{CC}=14V (unless otherwise specified)

Symbol	Parameter	Min.	Typ.	Max.	Units	Test Conditions
R _{ds(on)}	ON state resistance T _J =25°C	—	100	130	mΩ	V _{in} =5V, I _{ds} =1A
	ON state resistance T _J =150°C(2)	—	180	240		
I _{dss1}	Drain to source leakage current	—	0.01	1	μA	V _{CC} =14V, T _J =25°C
I _{dss2}	Drain to source leakage current	—	0.04	2		V _{CC} =50V, T _J =25°C
V _{clamp1}	Drain to source clamp voltage 1	63	68	—	V	I _d =20mA See fig. 3 & 4
V _{clamp2}	Drain to source clamp voltage 2	—	68	75		
V _{in clamp}	IN to source pin clamp voltage	5.5	6.2	7.5		
V _{th}	Input threshold voltage	1.1	2	2.7		
I _{in, on}	ON state IN positive current	15	40	80		
I _{in, off}	OFF state IN positive current (after protection latched)	150	250	350	μA	V _{in} =5V

Switching Electrical Characteristics

V_{CC}=14V, Resistive load=10Ω, R_{input}=50Ω, V_{in}=5V, T_J=25°C

Symbol	Parameter	Min.	Typ.	Max.	Units	Test Conditions
T _{don}	Turn-on delay time to 20%	0.4	1.3	4	μs	See figure 2
T _r	Rise time 20% to 80%	0.2	0.9	2		
T _{doff}	Turn-off delay time to 80%	1	3	8		
T _f	Fall time 80% to 20%	0.3	1.3	3		
E _{on} + E _{off}	Turn on and off energy	—	12	—	μJ	

Protection Characteristics

Symbol	Parameter	Min.	Typ.	Max.	Units	Test Conditions
T _{sd}	Over temperature threshold	150(2)	165	—	°C	See figure 1
I _{sd}	Over current threshold	4	5.5	7	A	See figure 1
OV	Over voltage protection (not active when the device is ON)	52	55	—	V	
V _{reset}	IN protection reset threshold	1.1	1.6	2	V	
T _{reset}	Time to reset protection	15(2)	50	500	μs	V _{in} =0V, T _J =25°C

(2) Guaranteed by design

Lead Assignments

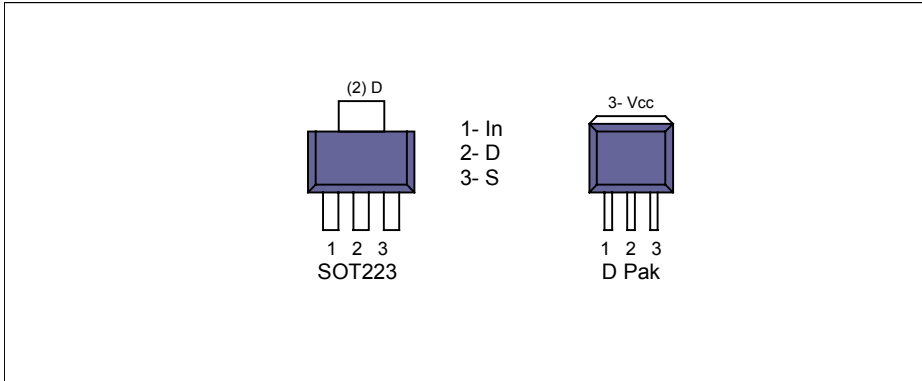

Functional Block Diagram

All values are typical

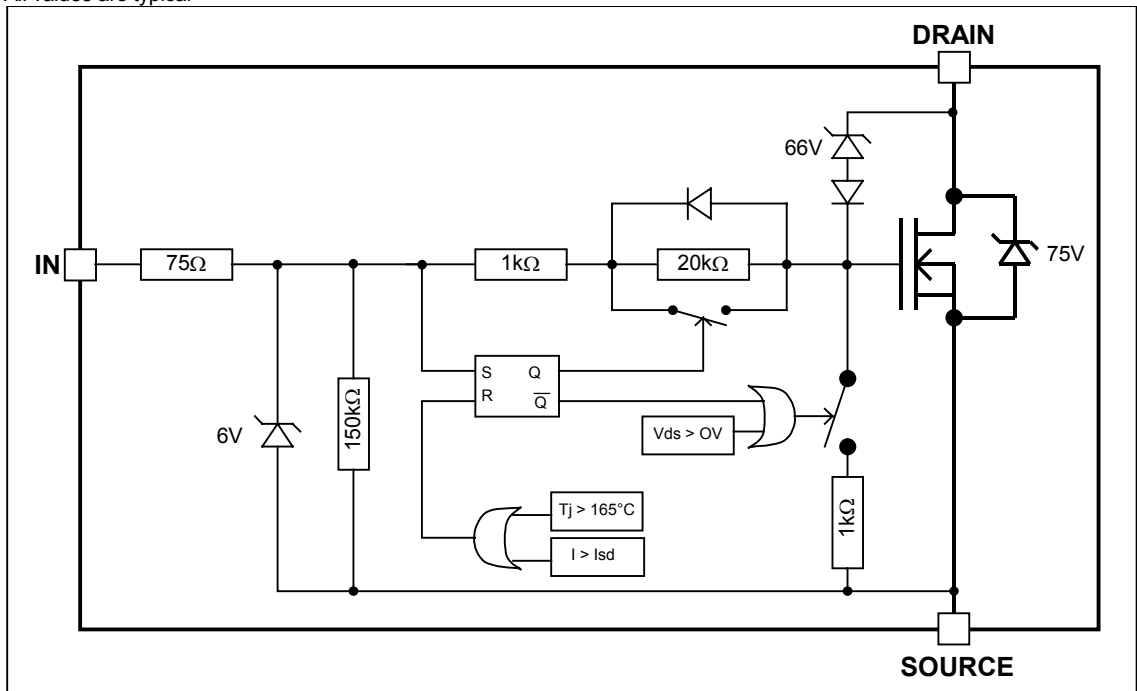

All curves are typical values. Operating in the shaded area is not recommended.

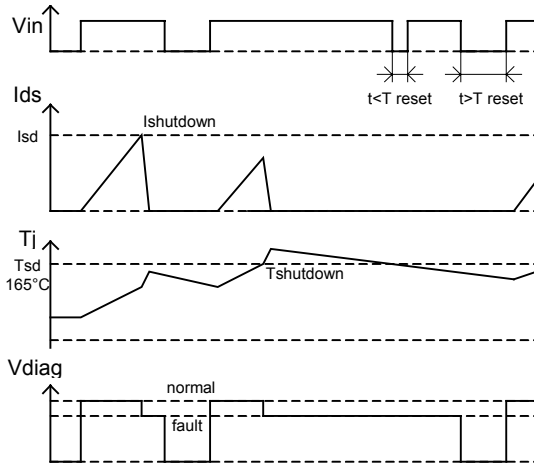

Figure 1 – Timing diagram

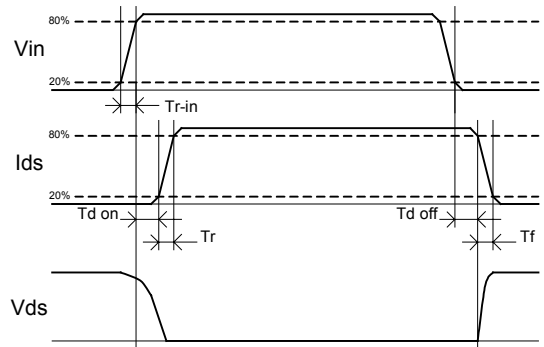

Figure 2 – IN rise time & switching definitions

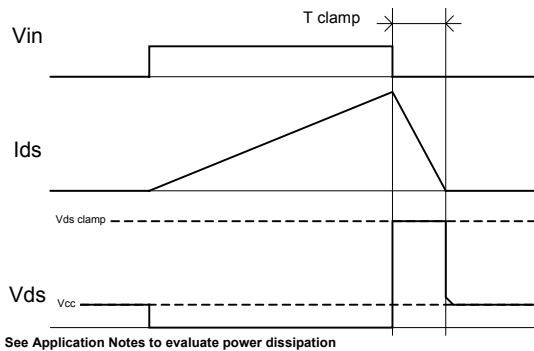

Figure 3 – Active clamp waveforms

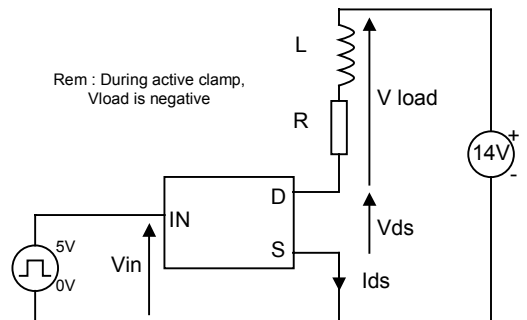

Figure 4 – Active clamp test circuit

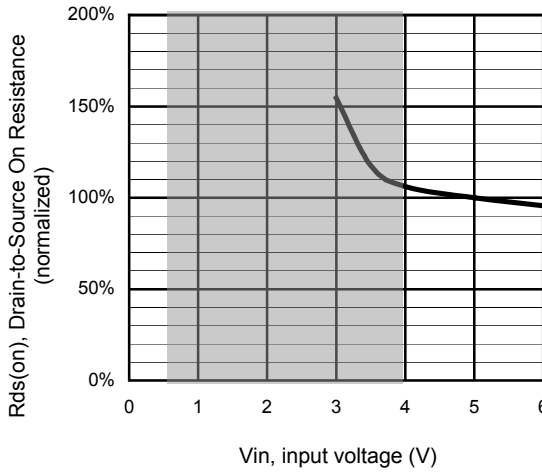

Figure 5 – Normalized R_{ds(on)} (%) Vs Input voltage (V)

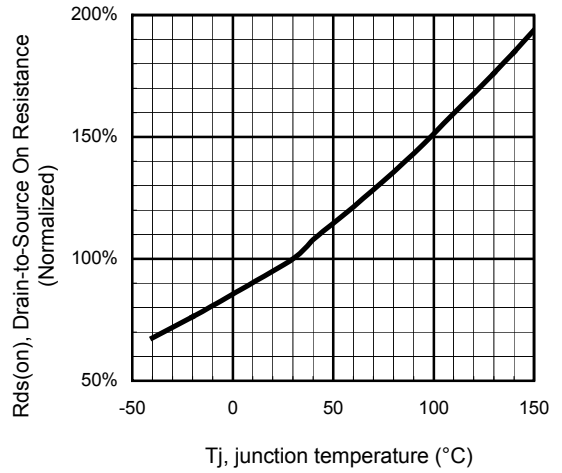

Figure 6 - Normalized R_{ds(on)} (%) Vs T_j (°C)

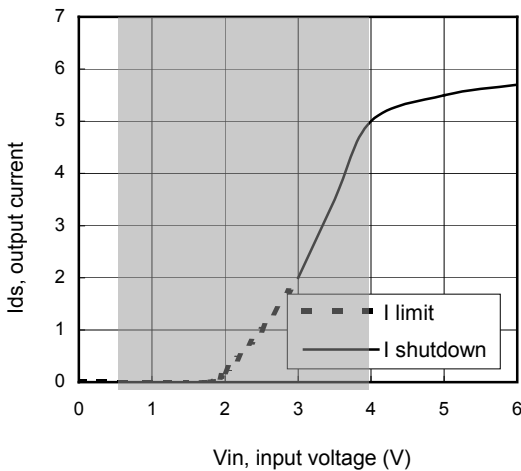

Figure 7 – Current limitation and current shutdown Vs Input voltage (V)

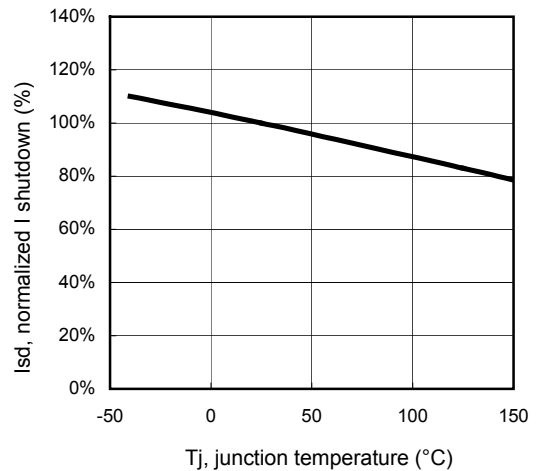

Figure 8 – Normalized I shutdown (%) Vs junction temperature (°C)

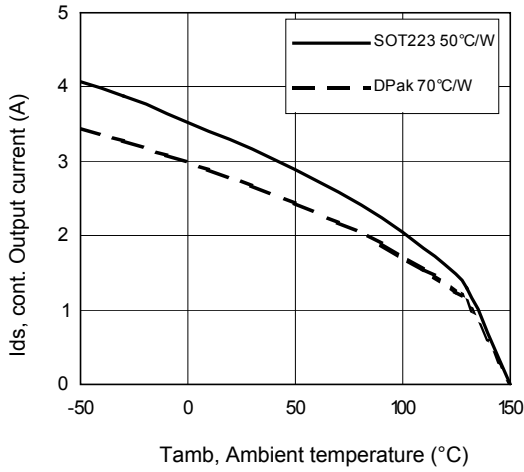

Figure 9 – Max. continuous output current (A) Vs Ambient temperature (°C)

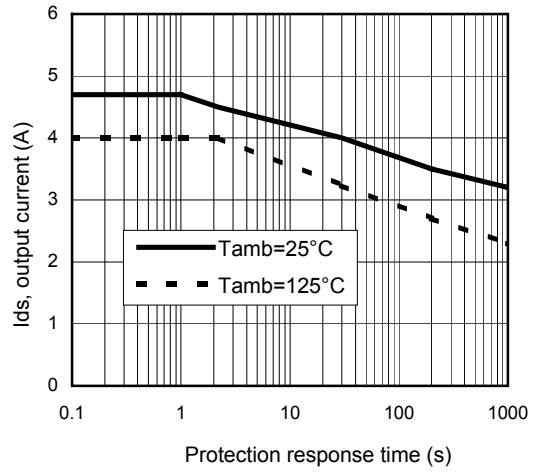

Figure 10 – Ids (A) Vs over temperature protection response time (s)

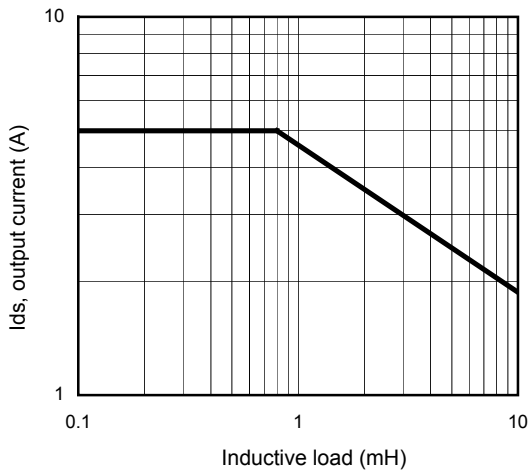

Figure 11 – Max. output current (A) Vs Inductive load (mH)

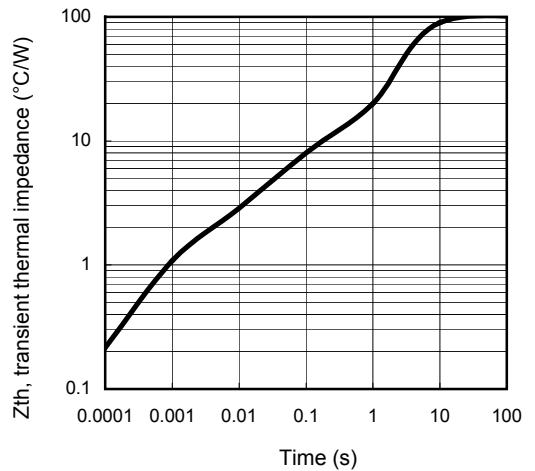

Figure 12 – Transient thermal impedance (°C/W) Vs time (s)

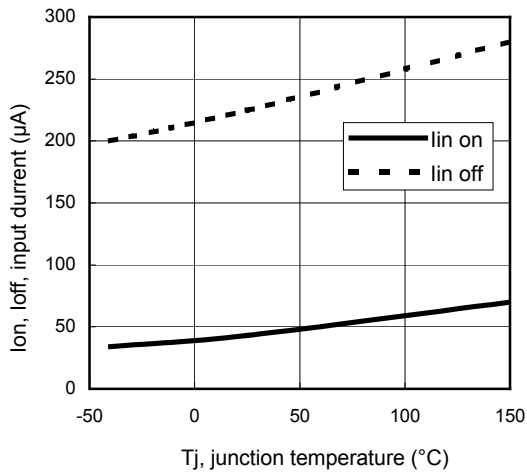

Figure 13 – Input current (µA) On and Off Vs junction temperature (°C)

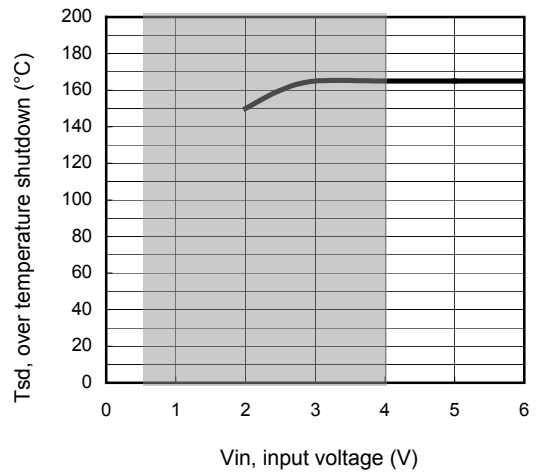
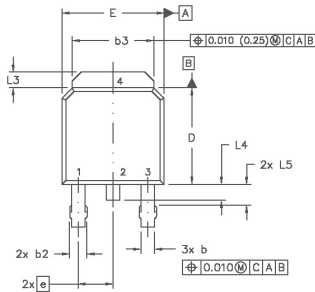
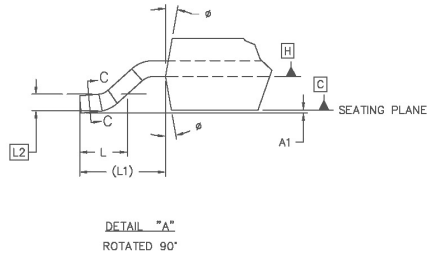
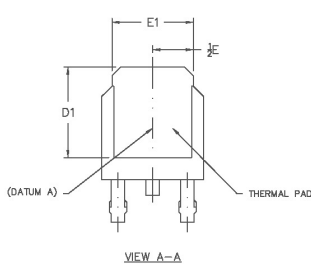
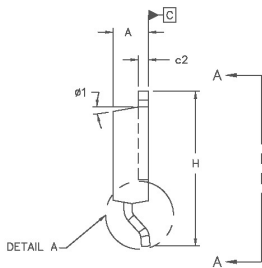
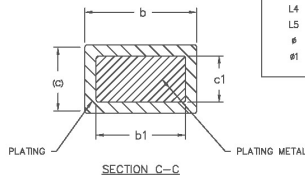

Figure 14 – Over temperature shutdown (°C) Vs input voltage (V)

Case outline – Dpak - Automotive Q100 PbF MSL1 qualified



SYMBOL	DIMENSIONS				NOTES
	MILLIMETERS		INCHES		
	MIN.	MAX.	MIN.	MAX.	
A	2.18	2.39	.086	.094	
A1		0.13		.005	
b	0.84	0.89	.025	.035	5
b1	0.84	0.79	.025	0.031	5
b2	0.76	1.14	.030	.045	
b3	4.95	5.46	.195	.215	
c	0.46	0.61	.018	.024	5
c1	0.41	0.56	.016	.022	5
c2	.046	0.89	.018	.035	5
D	5.97	6.22	.235	.245	6
D1	5.21	-	.205	-	4
E	8.35	6.73	.250	.265	6
E1	4.32	-	.170	-	4
e	2.29		.090 BSC		
H	9.40	10.41	.370	.410	
L	1.40	1.78	.055	.070	
L1	2.74 REF.		.108 REF.		
L2	0.051 BSC		.020 BSC		
L3	0.89	1.27	.035	.050	
L4		1.02		.040	
L5	1.14	1.52	.045	.060	
φ	0"	10"	0"	10"	
φ1	0"	15"	0"	15"	3



- NOTES:
- 1.0 DIMENSIONING AND TOLERANCING PER ASME Y14.5 M- 1994.
 - 2.0 DIMENSIONS ARE SHOWN IN INCHES [MILLIMETERS].
 - 3.0 LEAD DIMENSION UNCONTROLLED IN L5
 - 4.0 DIMENSION D1 AND E1 ESTABLISH A MINIMUM MOUNTING SURFACE FOR THERMAL PAD.
 - 5.0 SECTION C-C DIMENSIONS APPLY TO THE FLAT SECTION OF THE LEAD BETWEEN .005 [0.127] AND .010 [0.2540] FROM THE LEAD TIP.
 - 6.0 DIMENSION D & E DO NOT INCLUDE MOLD FLASH. MOLD FLASH SHALL NOT EXCEED .005" (0.127) PER SIDE. THESE DIMENSIONS ARE MEASURED AT THE OUTERMOST EXTREMES OF THE PLASTIC BODY.
 - 7.0 OUTLINE CONFORMS TO JEDEC OUTLINE TO-252AA.
 - 8.0 LEADS AND DRAIN ARE PLATED WITH 100% Sn

Tape & Reel – Dpak

Dimensions are shown in millimeters (inches)

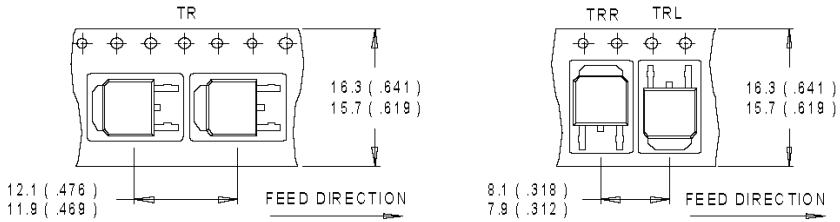

NOTES :

1. CONTROLLING DIMENSION : MILLIMETER.
2. ALL DIMENSIONS ARE SHOWN IN MILLIMETERS (INCHES).
3. OUTLINE CONFORMS TO EIA-481 & EIA-541.

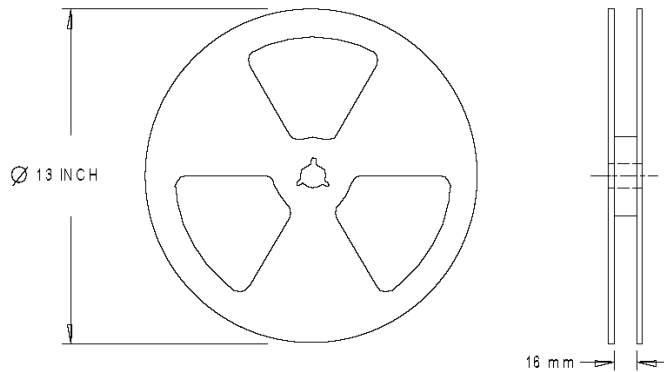

NOTES :

1. OUTLINE CONFORMS TO EIA-481.

Case Outline - SOT-223 - Automotive Q100 PbF MSL2 qualified

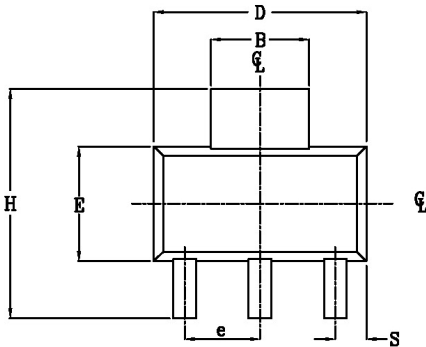

POS	MILLIMETERS		INCHES	
	MAX	MIN	MAX	MIN
1				
A	1.70	1.50	.067	.060
A1	0.10	0.02	.004	.0008
B	3.15	2.95	.124	.116
B1	0.85	0.65	.033	.028
C	0.35	0.25	.014	.010
D	6.70	6.30	.264	.248
e	2.30 NOM		.0905 NOM	
e1	4.60 NOM		.181 NOM	
E	3.70	3.30	.146	.130
H	7.30	6.70	.287	.264
S	1.05	0.85	.041	.033
t	1.30	1.10	.051	.043
∅	10° MAX		10° MAX	
∅1	16°	10°	16°	10°
∅2	16°	10°	16°	10°
L		0.75 MIN		0.0295 MIN

NOTE:
 1. PACKAGE OUTLINE EXCLUSIVE OF ANY MOLD FLASHES DIMENSION.
 2. PACKAGE OUTLINE EXCLUSIVE OF BURR DIMENSION.

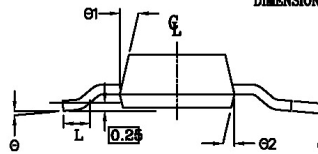
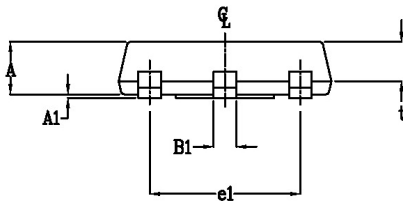

Leads and drain are plated with 100% Sn

Tape & Reel - SOT-223

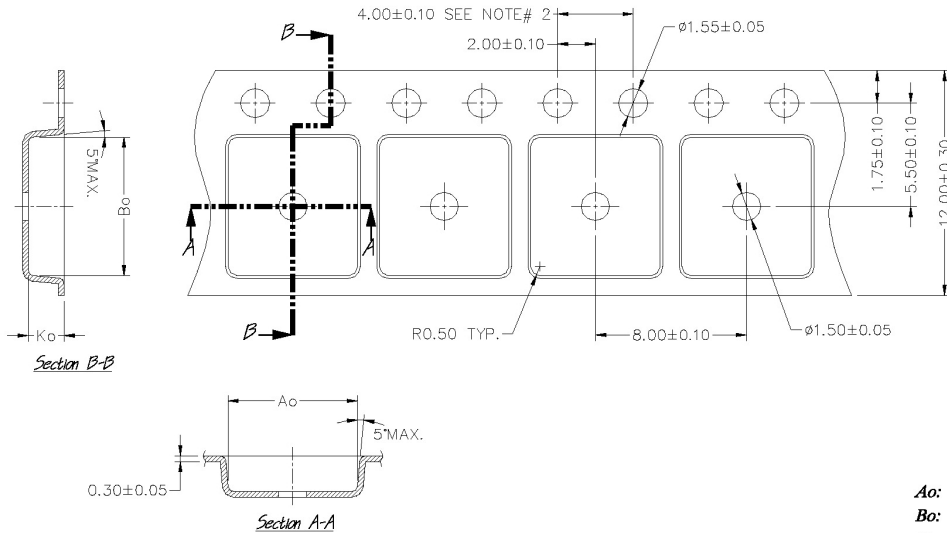

Ao:	6.85
Bo:	7.40
Ko:	1.90
Pitch:	8.00
Width:	12.00

NOTES:

1. A_o & B_o are measured at 0.3mm above base of pocket.
2. 10 pitches cumulative tol. ±0.2mm.

Note: For the most current drawings please refer to the IR website at:
<http://www.irf.com/package/>