



# 2764A 64K (8K x 8) UV ERASABLE PROMs

- Fast Access Time—HMOS\* II E  
— 180 ns Cerdip D2764A-1
- Moisture Resistant
- Two-line Control
- intelligent Identifier™ Mode
- Industry Standard Pinout ... JEDEC Approved ... 28 Lead Package  
(See Packaging Spec, Order #231369)

The Intel 2764A is a 5V only, 65,536-bit electrically programmable read-only memory (EPROM). The 2764A is fabricated with Intel's HMOSII-E technology which significantly reduces die size and greatly improves the device's performance, power consumption, reliability and producibility.

The 2764A provides access times to 180 ns (2764A-1). This is compatible with high-performance microprocessors, such as Intel's 8 MHz iAPX 186 allowing full speed operation without the addition of WAIT states. The 2764A is also directly compatible with the 12 MHz 8051 family.

Two-line control and JEDEC-approved, 28 pin packaging are standard features of Intel higher density EPROMs. This assures easy microprocessor interfacing and minimum design efforts when upgrading, adding, or choosing between non-volatile memory alternatives.

\*HMOS is a patented process of Intel Corporation.

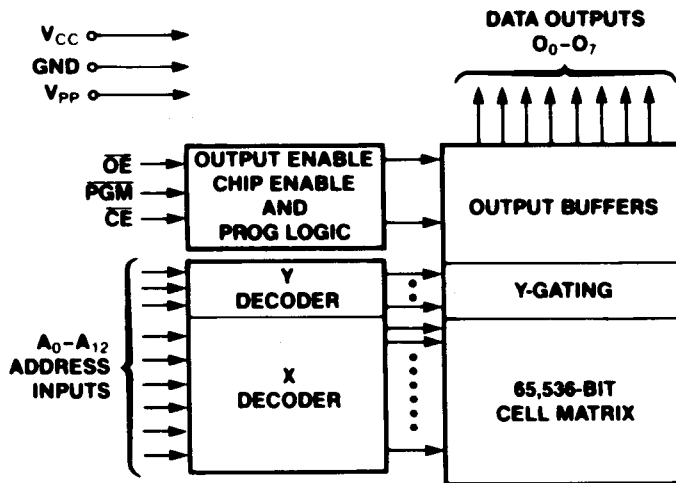

230864-1

Figure 1. Block Diagram

Pin Names

A <sub>0</sub> -A <sub>12</sub>	Addresses
CE	Chip Enable
OE	Output Enable
O <sub>0</sub> -O <sub>7</sub>	Outputs
PGM	Program
N.C.	No Connect

27512 27C512	27256 27C256	27128A 27C128	2732A	2716
A <sub>15</sub>	V <sub>PP</sub>	V <sub>PP</sub>		
A <sub>12</sub>	A <sub>12</sub>	A <sub>12</sub>		
A <sub>7</sub>	A <sub>7</sub>	A <sub>7</sub>	A <sub>7</sub>	A <sub>7</sub>
A <sub>6</sub>	A <sub>6</sub>	A <sub>6</sub>	A <sub>6</sub>	A <sub>6</sub>
A <sub>5</sub>	A <sub>5</sub>	A <sub>5</sub>	A <sub>5</sub>	A <sub>5</sub>
A <sub>4</sub>	A <sub>4</sub>	A <sub>4</sub>	A <sub>4</sub>	A <sub>4</sub>
A <sub>3</sub>	A <sub>3</sub>	A <sub>3</sub>	A <sub>3</sub>	A <sub>3</sub>
A <sub>2</sub>	A <sub>2</sub>	A <sub>2</sub>	A <sub>2</sub>	A <sub>2</sub>
A <sub>1</sub>	A <sub>1</sub>	A <sub>1</sub>	A <sub>1</sub>	A <sub>1</sub>
A <sub>0</sub>	A <sub>0</sub>	A <sub>0</sub>	A <sub>0</sub>	A <sub>0</sub>
O <sub>0</sub>	O <sub>0</sub>	O <sub>0</sub>	O <sub>0</sub>	O <sub>0</sub>
O <sub>1</sub>	O <sub>1</sub>	O <sub>1</sub>	O <sub>1</sub>	O <sub>1</sub>
O <sub>2</sub>	O <sub>2</sub>	O <sub>2</sub>	O <sub>2</sub>	O <sub>2</sub>
GND	GND	GND	GND	GND

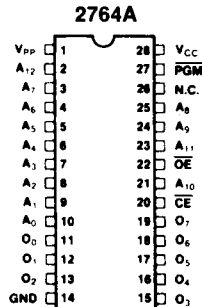

2716	2732A	27128A 27C128	27256 27C256	27512 27C512
		V <sub>CC</sub>	V <sub>CC</sub>	V <sub>CC</sub>
V <sub>CC</sub>	V <sub>CC</sub>	PGM	A <sub>14</sub>	A <sub>14</sub>
A <sub>8</sub>	A <sub>8</sub>	A <sub>13</sub>	A <sub>13</sub>	A <sub>13</sub>
A <sub>9</sub>	A <sub>9</sub>	A <sub>9</sub>	A <sub>9</sub>	A <sub>9</sub>
V <sub>PP</sub>	A <sub>11</sub>	A <sub>11</sub>	A <sub>11</sub>	A <sub>11</sub>
OE	OE/V <sub>PP</sub>	OE	OE	OE/V <sub>PP</sub>
A <sub>10</sub>	A <sub>10</sub>	A <sub>10</sub>	A <sub>10</sub>	A <sub>10</sub>
CE	CE	CE	CE	CE
O <sub>7</sub>	O <sub>7</sub>	O <sub>7</sub>	O <sub>7</sub>	O <sub>7</sub>
O <sub>6</sub>	O <sub>6</sub>	O <sub>6</sub>	O <sub>6</sub>	O <sub>6</sub>
O <sub>5</sub>	O <sub>5</sub>	O <sub>5</sub>	O <sub>5</sub>	O <sub>5</sub>
O <sub>4</sub>	O <sub>4</sub>	O <sub>4</sub>	O <sub>4</sub>	O <sub>4</sub>
O <sub>3</sub>	O <sub>3</sub>	O <sub>3</sub>	O <sub>3</sub>	O <sub>3</sub>

230864-2

NOTE:

Intel "Universal Site"-Compatible EPROM pin configurations are shown in the blocks adjacent to the 2764A pins.

Figure 2. Cerdip Pin Configuration

### EXTENDED TEMPERATURE (EXPRESS) EPROMs

The Intel EXPRESS EPROM family is a series of electrically programmable read only memories which have received additional processing to enhance product characteristics. EXPRESS processing is available for several densities of EPROM, allowing the choice of appropriate memory size to match system applications. EXPRESS EPROM products are

available with 168 ± 8 hour, 125°C dynamic burn-in using Intel's standard bias configuration. This process exceeds or meets most industry specifications of burn-in. The standard EXPRESS EPROM operating temperature range is 0°C to 70°C. Extended operating temperature range (-40°C to +85°C) EXPRESS products are available. Like all Intel EPROMs, the EXPRESS EPROM family is inspected to 0.1% electrical AQL. This may allow the user to reduce or eliminate incoming inspection testing.

### EXPRESS EPROM PRODUCT FAMILY

#### PRODUCT DEFINITIONS

Type	Operating Temperature	Burn-in 125°C (hr)
Q	0°C to +70°C	168 ± 8
T	-40°C to +85°C	None
L	-40°C to +85°C	168 ± 8

### EXPRESS OPTIONS

#### 2764A VERSIONS

Packaging Options	
Speed Versions	Cerdip
-20	Q, T, L

### READ OPERATION

#### D.C. CHARACTERISTICS

Electrical parameters of EXPRESS EPROM products are identical to standard EPROM parameters except for:

Symbol	Parameter	TD2764A LD2764A		Test Conditions
		Min	Max	
I <sub>SB</sub>	V <sub>CC</sub> Standby Current (mA)		40	$\overline{CE} = V_{IH}, \overline{OE} = V_{IL}$
I <sub>CC1</sub> (1)	V <sub>CC</sub> Active Current (mA)		100	$\overline{OE} = \overline{CE} = V_{IL}$
	V <sub>CC</sub> Active Current at High Temperature (mA)		75	$\overline{OE} = \overline{CE} = V_{IL}$ V <sub>PP</sub> = V <sub>CC</sub> , T <sub>Ambient</sub> = 85°C

#### NOTE:

1. The maximum current value is with outputs O<sub>0</sub> to O<sub>7</sub> unloaded.

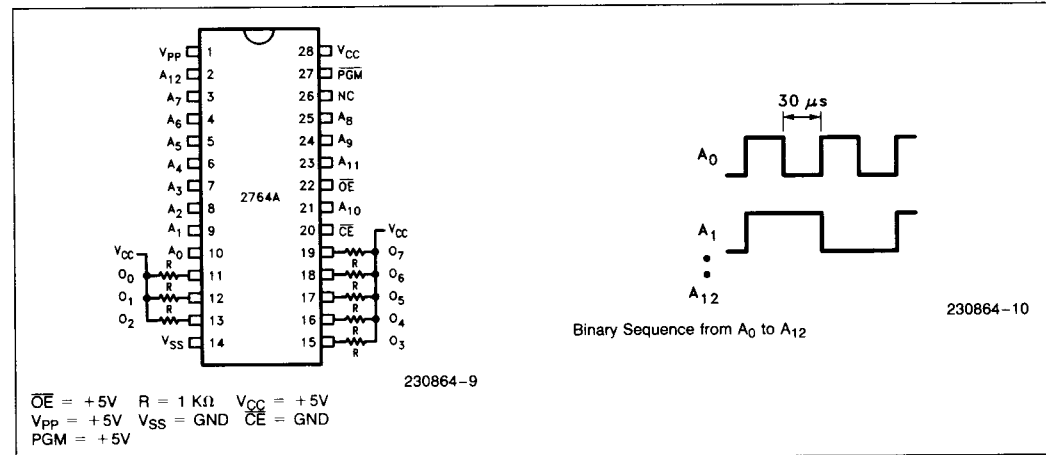

Burn-in Bias and Timing Diagrams

**ABSOLUTE MAXIMUM RATINGS\***

Operating Temperature	.....0°C to +70°C
During Read	.....0°C to +70°C
Temperature Under Bias	.....-10°C to +80°C
Storage Temperature	.....-65°C to +125°C
All Inputs or Output Voltages with	
Respect to Ground	.....-0.6V to +6.25V
Voltage on Pin 24 with	
Respect to Ground	.....-0.6V to +13.5V
V <sub>PP</sub> Supply Voltage with	
Respect to Ground	
During Programming	.....-0.6V to +14.0V

V<sub>CC</sub> Supply Voltage with Respect  
to Ground ..... -0.6V to +7.0V

NOTICE: This is a production data sheet. The specifications are subject to change without notice.

\*WARNING: Stressing the device beyond the "Absolute Maximum Ratings" may cause permanent damage. These are stress ratings only. Operation beyond the "Operating Conditions" is not recommended and extended exposure beyond the "Operating Conditions" may affect device reliability.

**READ OPERATION**
**D.C. CHARACTERISTICS** 0°C ≤ T<sub>A</sub> ≤ +70°C

Symbol	Parameter	Limits			Conditions
		Min	Max	Unit	
I <sub>LI</sub>	Input Load Current		10	μA	V <sub>IN</sub> = 0V to V <sub>CC</sub>
I <sub>LO</sub>	Output Leakage Current		10	μA	V <sub>OUT</sub> = 0V to V <sub>CC</sub>
I <sub>PP</sub> (2)	V <sub>PP</sub> Current Read		5	mA	V <sub>PP</sub> = 5.5V
I <sub>SB</sub>	V <sub>CC</sub> Current Standby		35	mA	$\overline{CE} = V_{IH}$
I <sub>CC</sub> (2)	V <sub>CC</sub> Current Active		75	mA	$\overline{CE} = \overline{OE} = V_{IL}$
V <sub>IL</sub>	Input Low Voltage	-0.1	+0.8	V	
V <sub>IH</sub>	Input High Voltage	2.0	V <sub>CC</sub> + 1	V	
V <sub>OL</sub>	Output Low Voltage		0.45	V	I <sub>OL</sub> = 2.1 mA
V <sub>OH</sub>	Output High Voltage	2.4		V	I <sub>OH</sub> = -400 μA
V <sub>PP</sub> (2)	V <sub>PP</sub> Read Voltage	3.8	V <sub>CC</sub>	V	V <sub>CC</sub> = 5.0V ± 0.25V

5

**A.C. CHARACTERISTICS** 0°C ≤ T<sub>A</sub> ≤ +70°C

Versions(4)	V <sub>CC</sub> ± 5%	2764A-1		2764A-2		2764A		Unit	Test Conditions
	V <sub>CC</sub> ± 10%	2764A-20		2764A-25					
Symbol	Parameter	Min	Max	Min	Max	Min	Max		
t <sub>ACC</sub>	Address to Output Delay		180		200		250	ns	$\overline{CE} = \overline{OE} = V_{IL}$
t <sub>CE</sub>	$\overline{CE}$ to Output Delay		180		200		250	ns	$\overline{OE} = V_{IL}$
t <sub>OE</sub>	$\overline{OE}$ to Output Delay		65		75		100	ns	$\overline{CE} = V_{IL}$
t <sub>DF</sub> (3)	$\overline{OE}$ High to Output Float	0	55	0	55	0	60	ns	$\overline{CE} = V_{IL}$
t <sub>OH</sub> (3)	Output Hold from Address, $\overline{CE}$ or $\overline{OE}$ Whichever Occurred First	0		0		0		ns	$\overline{CE} = \overline{OE} = V_{IL}$

**NOTES:**

- V<sub>CC</sub> must be applied simultaneously or before V<sub>PP</sub> and removed simultaneously or after V<sub>PP</sub>.
- V<sub>PP</sub> may be connected directly to V<sub>CC</sub> except during programming. The supply current would then be the sum of I<sub>CC</sub> and I<sub>PP</sub>. The maximum current value is with outputs O<sub>0</sub> to O<sub>7</sub> unloaded.
- This parameter is only sampled and is not 100% tested. Output Data Float is defined as the point where data is no longer driven—see timing diagram on the following page.
- Model Number Prefixes: No prefix = CERDIP.

**CAPACITANCE(2)** ( $T_A = 25^\circ\text{C}$ ,  $f = 1\text{ MHz}$ )

Symbol	Parameter	Typ (1)	Max	Unit	Conditions
$C_{IN}$	Input Capacitance	4	6	pF	$V_{IN} = 0V$
$C_{OUT}$	Output Capacitance	8	12	pF	$V_{OUT} = 0V$

**A.C. TESTING INPUT/OUTPUT WAVEFORM**

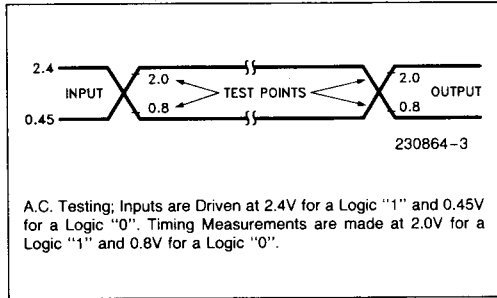

**A.C. TESTING LOAD CIRCUIT**

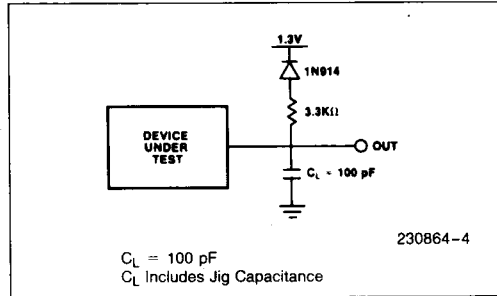

**A.C. WAVEFORMS**

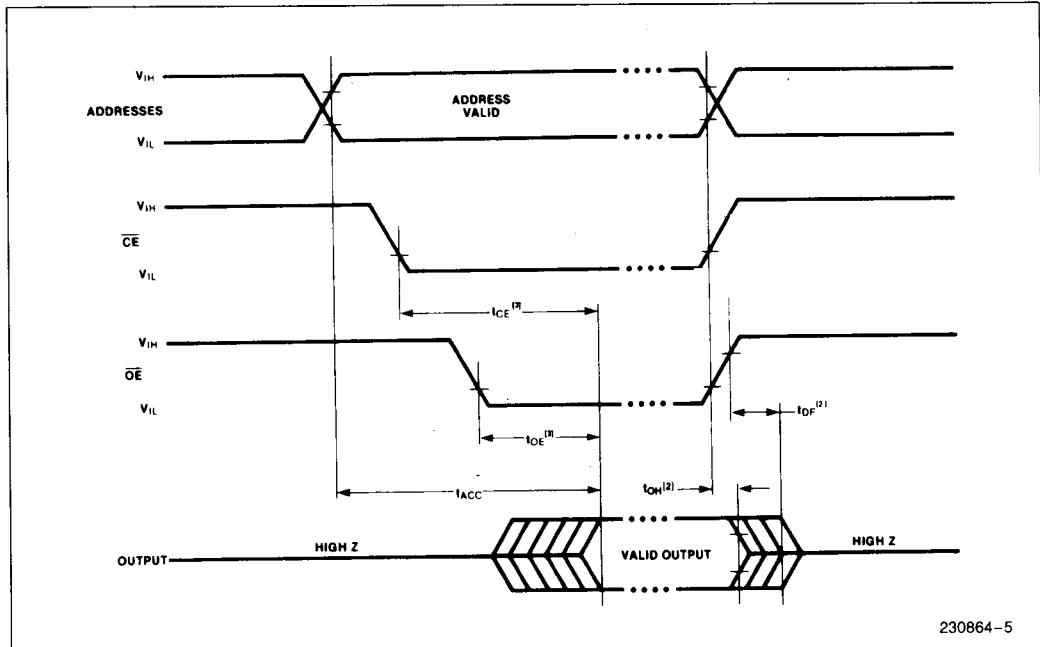

**NOTES:**

1. Typical values are for  $T_A = 25^\circ\text{C}$  and nominal supply voltages.
2. This parameter is only sampled and is not 100% tested.
3.  $\overline{OE}$  may be delayed up to  $t_{CE} - t_{OE}$  after the falling edge of  $\overline{CE}$  without impact on  $t_{CE}$ .

## DEVICE OPERATION

The modes of operation of the 2764A are listed in Table 1. A single 5V power supply is required in the read mode. All inputs are TTL levels except for  $V_{PP}$  and 12V on  $A_9$  for intelligent identifier mode.

Table 1. Mode Selection

	Pins								
Mode	$\overline{CE}$	$\overline{OE}$	PGM	$A_9$	$A_0$	$V_{PP}$	$V_{CC}$	Outputs	
Read	$V_{IL}$	$V_{IL}$	$V_{IH}$	X <sup>(1)</sup>	X	$V_{CC}$	5.0V	D <sub>OUT</sub>	
Output Disable	$V_{IL}$	$V_{IH}$	$V_{IH}$	X	X	$V_{CC}$	5.0V	High Z	
Standby	$V_{IH}$	X	X	X	X	$V_{CC}$	5.0V	High Z	
Programming	$V_{IL}$	$V_{IH}$	$V_{IL}$	X	X	(4)	(4)	D <sub>IN</sub>	
Program Verify	$V_{IL}$	$V_{IL}$	$V_{IH}$	X	X	(4)	(4)	D <sub>OUT</sub>	
Program Inhibit	$V_{IH}$	X	X	X	X	(4)	(4)	High Z	
intelligent Identifier <sup>(3)</sup>									
—manufacturer	$V_{IL}$	$V_{IL}$	$V_{IH}$	$V_{H(2)}$	$V_{IL}$	$V_{CC}$	5.0V	89H	
—device	$V_{IL}$	$V_{IL}$	$V_{IH}$	$V_{H(2)}$	$V_{IH}$	$V_{CC}$	5.0V	08H	

### NOTES:

1. X can be  $V_{IH}$  or  $V_{IL}$ .
2.  $V_H = 12.0V \pm 0.5V$ .
3.  $A_1-A_8, A_{10}-A_{12} = V_{IL}$ .
4. See Table 2 for  $V_{CC}$  and  $V_{PP}$  voltages.

## Read Mode

The 2764A has two control functions, both of which must be logically active in order to obtain data at the outputs. Chip Enable ( $\overline{CE}$ ) is the power control and should be used for device selection. Output Enable ( $\overline{OE}$ ) is the output control and should be used to gate data from the output pins, independent of device selection. Assuming that addresses are stable, the address access time ( $t_{ACC}$ ) is equal to the delay from  $\overline{CE}$  to output ( $t_{CE}$ ). Data is available at the outputs after a delay of  $t_{OE}$  from the falling edge of  $\overline{OE}$ , assuming that  $\overline{CE}$  has been low and addresses have been stable for at least  $t_{ACC}-t_{OE}$ .

## Standby Mode

EPROMs can be placed in a standby mode which reduces the maximum current of the devices by applying a TTL-high signal to the  $\overline{CE}$  input. When in the standby mode, the outputs are in a high impedance state, independent of the  $\overline{OE}$  input.

## Two Line Output Control

Because EPROMs are usually used in larger memory arrays, Intel has provided 2 control lines which accommodate this multiple memory connection. The two control lines allow for:

- a) the lowest possible memory power dissipation, and
- b) complete assurance that output bus contention will not occur.

To use these two control lines most efficiently,  $\overline{CE}$  should be decoded and used as the primary device selecting function, while  $\overline{OE}$  should be made a common connection to all devices in the array and connected to the READ line from the system control bus. This assures that all deselected memory devices are in their low power standby mode and that the output pins are active only when data is desired from a particular memory device.

## SYSTEM CONSIDERATIONS

The power switching characteristics of EPROMs require careful decoupling of the devices. The supply current,  $I_{CC}$ , has three segments that are of interest to the system designer—the standby current level, the active current level, and the transient current peaks that are produced by the falling and rising edges of Chip Enable. The magnitude of these transient current peaks is dependent on the output capacitive and inductive loading of the device. The associated transient voltage peaks can be suppressed by complying with Intel's Two-Line Control and by properly selected decoupling capacitors. It is recommended that a 0.1  $\mu F$  ceramic capacitor be used on every device between  $V_{CC}$  and GND. This should be a high frequency capacitor of low inherent inductance and should be placed as close to the device as possible. In addition, a 4.7  $\mu F$  bulk electrolytic capacitor should be used between  $V_{CC}$  and GND for every eight devices. The bulk capacitor should be located near where the power supply is connected to the array. The purpose of the bulk capacitor is to overcome the voltage droop caused by the inductive effect of PC board-traces.

5

## PROGRAMMING MODES

**Caution: Exceeding 14V on  $V_{PP}$  will permanently damage the device.**

Initially, all bits of the EPROM are in the "1" state. Data is introduced by selectively programming "0s" into the desired bit locations. Although only "0s" will be programmed, both "1s" and "0s" can be present in the data word. The only way to change a "0" to a "1" is by ultraviolet light exposure (Cerdip EPROMs).

The device is in the programming mode when  $V_{PP}$  is raised to its programming voltage (see Table 2) and  $\overline{CE}$  and PGM are both at TTL-low. The data to be programmed is applied 8 bits in parallel to the data output pins. The levels required for the address and data inputs are TTL.

## Program Inhibit

Programming of multiple EPROMs in parallel with different data is easily accomplished by using the Program Inhibit mode. A high-level  $\overline{CE}$  or  $\overline{PGM}$  input inhibits the other devices from being programmed.

Except for  $\overline{CE}$ , all like inputs (including  $\overline{OE}$ ) of the parallel EPROMs may be common. A TTL low-level pulse applied to the  $\overline{CE}$  input with  $V_{PP}$  at its programming voltage (see Table 2) will program the selected device.

## Program Verify

A verify should be performed on the programmed bits to determine that they have been correctly programmed. The verify is performed with  $\overline{OE}$  at  $V_{IL}$ ,  $\overline{PGM}$  at  $V_{IH}$  and  $V_{PP}$  and  $V_{CC}$  at their programming voltages.

## intelligent Identifier™ Mode

The intelligent Identifier Mode allows the reading out of a binary code from an EPROM that will identify its manufacturer and type. This mode is intended for use by programming equipment for the purpose of automatically matching the device to be programmed with its corresponding programming algorithm. This mode is functional in the  $25^{\circ}\text{C} \pm 5^{\circ}\text{C}$  ambient temperature range that is required when programming the device.

To activate this mode, the programming equipment must force 11.5V to 12.5V on address line A9 of the EPROM. Two identifier bytes may then be sequenced from the device outputs by toggling ad-

dress line A0 from  $V_{IL}$  to  $V_{IH}$ . All other address lines must be held at  $V_{IL}$  during intelligent Identifier Mode.

Byte 0 ( $A0 = V_{IL}$ ) represents the manufacturer code and byte 1 ( $A0 = V_{IH}$ ) the device identifier code. These two identifier bytes are given in Table 1.

## ERASURE CHARACTERISTICS

The erasure characteristics are such that erasure begins to occur upon exposure to light with wavelengths shorter than approximately 4000 Angstroms ( $\text{\AA}$ ). It should be noted that sunlight and certain types of fluorescent lamps have wavelengths in the 3000–4000  $\text{\AA}$  range. Data shows that constant exposure to room level fluorescent lighting could erase the EPROM in approximately three years, while it would take approximately one week to cause erasure when exposed to direct sunlight. If the EPROM is to be exposed to these types of lighting conditions for extended periods of time, opaque labels should be placed over the window to prevent unintentional erasure.

The recommended erasure procedure is exposure to shortwave ultraviolet light which has a wavelength of 2537 Angstroms ( $\text{\AA}$ ). The integrated dose (i.e., UV intensity  $\times$  exposure time) for erasure should be a minimum of fifteen (15) Wsec/cm<sup>2</sup>. The erasure time with this dosage is approximately 15 to 20 minutes using an ultraviolet lamp with a 12,000  $\mu\text{W}/\text{cm}^2$  power rating. The EPROM should be placed within one inch of the lamp tubes during erasure. The maximum integrated dose an EPROM can be exposed to without damage is 7258 Wsec/cm<sup>2</sup> (1 week @ 12000  $\mu\text{W}/\text{cm}^2$ ). Exposure of the EPROM to high intensity UV light for longer periods may cause permanent damage.

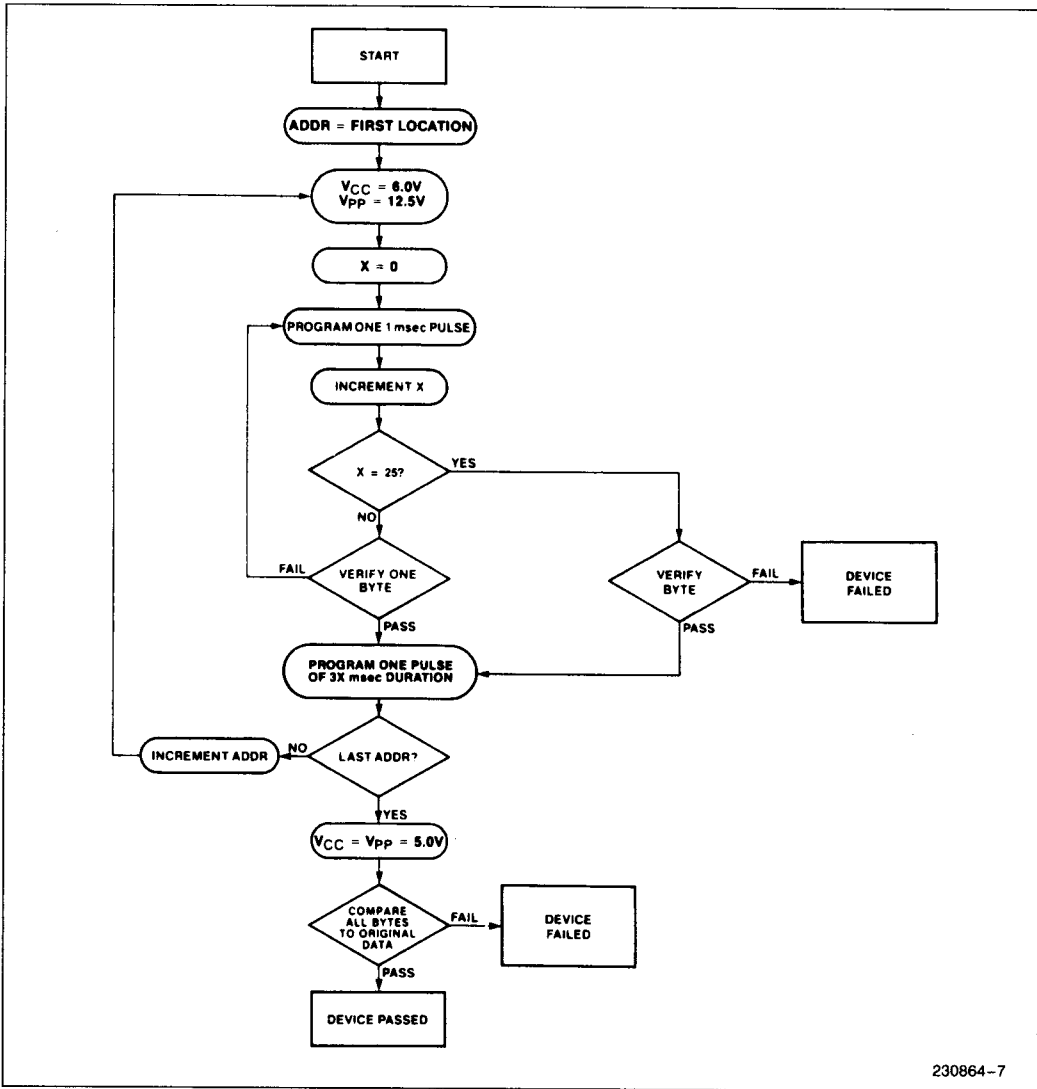

Figure 3. intelligent Programming™ Flowchart

### intelligent Programming™ Algorithm

The intelligent Programming Algorithm, a standard in the industry for the past few years, is required for all of Intel's 12.5V CERDIP EPROMs. Plastic EPROMs may also be programmed using this method. A flowchart of the intelligent Programming Algorithm is shown in Figure 3.

The intelligent Programming Algorithm utilizes two different pulse types: initial and overprogram. The duration of the initial PGM pulse(s) is one millisecond, which will then be followed by a longer overpro-

gram pulse of length 3X msec. X is an iteration counter and is equal to the number of the initial one millisecond pulses applied to a particular location, before a correct verify occurs. Up to 25 one-millisecond pulses per byte are provided for before the overprogram pulse is applied.

**The entire sequence of program pulses and byte verifications is performed at  $V_{CC} = 6.0V$  and  $V_{pp} = 12.5V$ .** When the intelligent Programming cycle has been completed, all bytes should be compared to the original data with  $V_{CC} = V_{pp} = 5.0V$ .



Table 2

**D.C. PROGRAMMING CHARACTERISTICS**  $T_A = 25^\circ\text{C} \pm 5^\circ\text{C}$ 

Symbol	Parameter	Limits			Test Conditions (see Note 1)
		Min	Max	Unit	
$I_{LI}$	Input Current (All Inputs)		10	$\mu\text{A}$	$V_{IN} = V_{IL}$ or $V_{IH}$
$V_{IL}$	Input Low Level (All Inputs)	-0.1	0.8	V	
$V_{IH}$	Input High Level	2.0	$V_{CC}$	V	
$V_{OL}$	Output Low Voltage During Verify		0.45	V	$I_{OL} = 2.1\text{ mA}$
$V_{OH}$	Output High Voltage During Verify	2.4		V	$I_{OH} = -400\ \mu\text{A}$
$I_{CC2}^{(4)}$	$V_{CC}$ Supply Current (Program & Verify)		75	mA	
$I_{PP2}^{(4)}$	$V_{PP}$ Supply Current (Program)		50	mA	$\overline{CE} = V_{IL}$
$V_{ID}$	$A_9$ intelligent Identifier Voltage	11.5	12.5	V	
$V_{PP}$	intelligent Programming Algorithm	12.0	13.0	V	$\overline{CE} = \text{PGM} = V_{IL}$
$V_{CC}$	intelligent Programming Algorithm	5.75	6.25	V	

**A.C. PROGRAMMING CHARACTERISTICS**
 $T_A = 25^\circ\text{C} \pm 5^\circ\text{C}$  (see table 2 for  $V_{CC}$  and  $V_{PP}$  voltages)

Symbol	Parameter	Limits				Test Conditions* (see Note 1)
		Min	Typ	Max	Unit	
$t_{AS}$	Address Setup Time	2			$\mu\text{s}$	
$t_{OES}$	$\overline{OE}$ Setup Time	2			$\mu\text{s}$	
$t_{DS}$	Data Setup Time	2			$\mu\text{s}$	
$t_{AH}$	Address Hold Time	0			$\mu\text{s}$	
$t_{DH}$	Data Hold Time	2			$\mu\text{s}$	
$t_{DFP}$	$\overline{OE}$ High to Output Float Delay	0		130	ns	(See Note 3)
$t_{VPS}$	$V_{PP}$ Setup Time	2			$\mu\text{s}$	
$t_{VCS}$	$V_{CC}$ Setup Time	2			$\mu\text{s}$	
$t_{CES}$	$\overline{CE}$ Setup Time	2			$\mu\text{s}$	
$t_{PW}$	PGM Initial Program Pulse Width	0.95	1.0	1.05	ms	
$t_{OPW}$	PGM Overprogram Pulse Width	2.85		78.75	ms	(see Note 2)
$t_{OE}$	Data Valid from $\overline{OE}$			150	ns	

**\*A.C. CONDITIONS OF TEST**

Input Rise and Fall Times  
 (10% to 90%) ..... 20 ns  
 Input Pulse Levels ..... 0.45V to 2.4V  
 Input Timing Reference Level ..... 0.8V and 2.0V  
 Output Timing Reference Level ..... 0.8V and 2.0V

**NOTES:**

- $V_{CC}$  must be applied simultaneously or before  $V_{PP}$  and removed simultaneously or after  $V_{PP}$ .
- The length of the overprogram pulse may vary from 2.85 msec to 78.75 msec as a function of the iteration counter value X.
- This parameter is only sampled and is not 100% tested. Output Float is defined as the point where data is no longer driven—see timing diagram.
- The maximum current value is with Outputs  $O_0$  to  $O_7$  unloaded.

**PROGRAMMING WAVEFORMS**

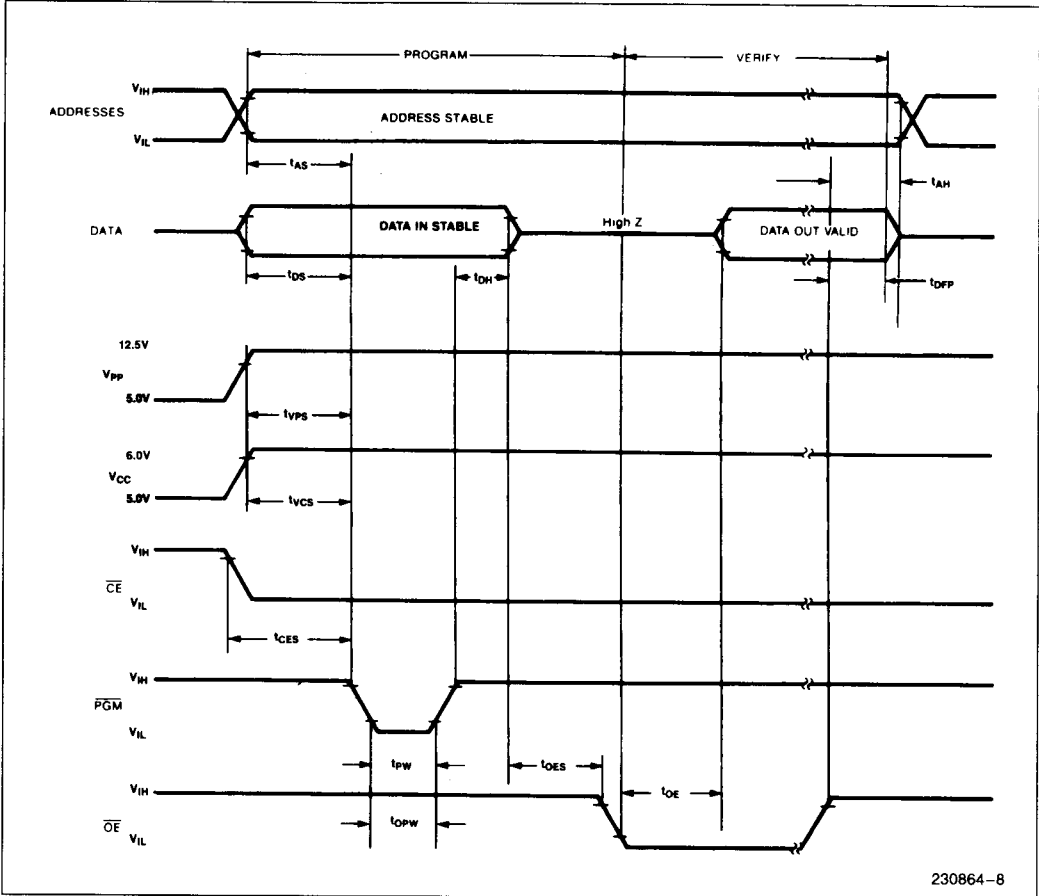

230864-8

5

**NOTES:**

1. The input timing reference level is 0.8V for V<sub>IL</sub> and 2V for a V<sub>IH</sub>.
2. t<sub>OE</sub> and t<sub>DFP</sub> are characteristics of the device but must be accommodated by the programmer.
3. When programming the 2764A, a 0.1 μF capacitor is required across V<sub>PP</sub> and ground to suppress spurious voltage transients which can damage the device.

**REVISION HISTORY**

Number	Description
06	Deleted Plastic DIP package. Deleted QuickPulse sections. Revised Pin Configuration. Revised Express options. Deleted -3, -30, -4 and -45 speed bins. D.C. Characteristics - I <sub>LI</sub> Conditions are V <sub>IN</sub> = 0V to V <sub>CC</sub> D.C. Characteristics - I <sub>LO</sub> Conditions are V <sub>OUT</sub> = 0V to V <sub>CC</sub>