

UEP for Video Transmission in Space-Time Coded OFDM Systems

Guang-Hua Yang, Dongxu Shen, Victor O.K. Li
Department of Electrical and Electronic Engineering
The University of Hong Kong
Pokfulam Road, Hong Kong
Email: {ghyang, dxshen, vli}@eee.hku.hk

Abstract— In this paper, we provide a sub-channel partitioning based unequal error protection (UEP) scheme for a space-time block coded orthogonal frequency division multiplexing (STBC-OFDM) system. In such a scheme, video data is partitioned into high-priority (HP) and low-priority (LP) layers according to the importance of the data. At the receiver side, OFDM sub-channels are partitioned into high-quality (HQ) and low-quality (LQ) groups according to the estimated channel qualities. Based on the feedback of sub-channel partitioning results, the transmitter assigns HP and LP video data to the corresponding HQ and LQ sub-channels. Through theoretical analysis, we show there is indeed a significant BER difference between the HQ and LQ sub-channels, which can be exploited by UEP. Based on the analysis, we provide a criterion for determining the appropriate transmission power. Through computer simulations, we show that the proposed scheme offers significant performance gain compared to conventional methods. We also demonstrate that the scheme is the least sensitive to channel estimation errors among all compared schemes, and is hardly influenced by the Doppler spread. The feedback overhead can also be reduced with almost no performance penalty by bundling several neighboring sub-channels together and assigning them to the same group.

I. INTRODUCTION

Providing high-quality video services is an important task for future wireless broadband communication systems [1]. The main challenge is to efficiently transmit high rate error-sensitive video data over error-prone wireless channels. In this work, we propose an unequal error protection (UEP) scheme by exploiting the features of space-time block coded orthogonal frequency division multiplexing (STBC-OFDM) systems through sub-channel partitioning.

OFDM [2] is particularly suitable for high data rate transmission, in which a wideband frequency selective fading channel is transformed into multiple narrow-band flat fading sub-channels. With a sufficiently long prefix, inter-symbol interference (ISI) can be completely avoided, thus accommodating high data rate transmission. The performance of OFDM can be greatly enhanced by STBC [3] through the employment of transmit diversity.

UEP is an effective method for video transmission in error-prone environments. It provides different levels of protection to different parts of video data which have unequal degrees of importance. Basically, UEP changes the distribution of errors without incurring extra resource consumption. Less bit errors are suffered by more important data. To achieve UEP, video data has to be divided into two or more layers of different priorities. With two layers, for example, the high-priority (HP) layer carries more vital data and can be decoded by itself to reconstruct the video with acceptable quality; the low-priority (LP) layer carries less important data which is used to improve the video quality. Errors in the HP layer have detrimental effects on the reconstructed video quality and should thus be avoided as much as possible. On the other hand, errors in the LP layer are more tolerable. Therefore, UEP targets to provide the best possible protection to the HP layer to achieve good video quality. Currently, layered coding is supported by major video compression standards, such as MPEG-2 and H.263++.

A common approach for UEP is based on forward error correction (FEC) [4]. The idea is to provide different degrees of FEC protection to video data of different priorities. This scheme is originally proposed for single-carrier systems and could be easily extended to multi-carrier systems.

In multi-carrier systems, such as OFDM, the sub-channels undergo different levels of fading, which can be exploited to achieve UEP. In [5], an UEP method is proposed for an OFDM system by grouping sub-channels according to their channel gains, and power control is employed so that the sub-channels belonging to the same group have the same signal-to-noise ratio (SNR). However, the achievement of such power control is not very practical, since the channel profile (or the transmission power) on all sub-channels need to be fed back from the receiver to the transmitter. An explicit illustration of the feedback scheme is not provided in [5], nor is the overhead issue discussed. Further, many other factors, such as channel estimation errors and channel variations, are also not considered in [5].

In this work, we propose an UEP scheme for STBC-OFDM systems through sub-channel partitioning. In such systems, channel estimation is essential at the receiver, and utilized to classify the sub-channels into groups. The group membership of all sub-channels are represented by a bit vector, named partition vector (PV). With two groups, say, a high quality (HQ) and a low quality (LQ) group, only a single bit is needed for each sub-channel and the length of the PV just equals the number of sub-channels. The PV is then fed back to the transmitter. Obviously, this feedback overhead is acceptable when there is a limited number of sub-channels, and can be further reduced if several neighboring sub-channels are bundled and assigned to the same group. At the transmitter, video data is also partitioned into layers. Corresponding to the partitioning at the receiver, we assume there are two layers, an HP layer and an LP layer. According to the fed back PV, the HP and LP data are assigned to the corresponding HQ and LQ sub-channels for transmission. Through theoretical analysis, we show there is indeed a significant BER difference between the HQ and LQ sub-channel groups. Further, based on the analysis, we provide a method to determine the appropriate transmission power. Some performance related factors for our UEP scheme are also discussed. Through computer simulations, we show that the proposed scheme exhibits consistently better performance than the commonly used FEC-based UEP scheme for different configurations. We also show that the proposed scheme is robust against channel estimation errors, channel variations, and variations in sub-channel bundle size.

This paper is organized as follows. In Section II, we provide the backgrounds of layered video coding, UEP, and STBC-OFDM. In Section III, we present our sub-channel partitioning based UEP scheme. In Section IV, we analyze the proposed scheme and discuss the performance related factors. In Section V, we provide simulation results. Conclusion is given in Section VI.

II. BACKGROUND

A. UEP and Data Partitioning

UEP is based on layered video coding. Data partitioning is the simplest form of layered coding. Compared with single-layer schemes, data partitioning combined with UEP provides considerably more error resilience with little extra complexity and overhead.

In this paper, data partitioning on MPEG-2 video is adopted. Fig. 1 presents the data structure of MPEG-2 compressed video [6], which consists of a sequence of pictures (frames). These pictures are divided into groups, namely, group of pictures (GOPs). One GOP is a self-decodable set of frames containing I, P and B pictures. Each picture consists of a number of slices. One slice has 16 lines of pixels divided into macro-blocks

(MBs). An MB represents a block of 16×16 pixels. For a 4 : 2 : 0 format MB, there are 6 blocks, four for luminance and two for chrominance. The chrominance blocks are half sampled with respect to the luminance blocks. Discrete cosine transform (DCT) is applied to each block and the output is quantized. Then the non-zero DCT coefficients, except the lowest one, are 'zigzag' scanned and run-level coded into variable length codes (VLCs) [6].

The structure of the coded bit-stream is also shown in Fig. 1. The headers of different levels (sequence, GOPs, pictures, slices, MBs, etc.) carry critical information and are used for synchronization. Errors in headers will render the current level undecodable. For example, the decoder will skip a picture if the picture header contains errors. VLCs are also sensitive to errors. One bit error and/or bit loss in VLCs may cause the loss of synchronization, which leads to undecodable bit strings until the synchronization marker carried by the next header is found. On the other hand, VLCs of different orders have different importance. Lower order VLCs are more important to the final video quality than higher order ones. The above properties of video data make UEP suitable for video transmission.

Data partitioning can be realized without the need to modify the original single-layer encoder. After partitioning, the bit stream from a single-layer encoder is divided into two layers, say, an HP and an LP layer, according to the different importance of data. Data partitioning can be done at different levels. Usually, partitioning is performed on the block level, in which VLCs in each block are partitioned into different layers. The HP layer includes the most vital data, such as all the headers, motion vectors, and low order VLCs; the LP layer contains the rest of the VLCs and the redundancy copies of certain headers. The number of VLCs partitioned into the HP layer is determined by the priority break point (PBP). PBP may be fixed, or varied to control the data rate ratio of the two layers. In Fig. 1, an example of data partitioning is shown, in which two VLCs of each block are placed in the HP layer.

B. Space-time block coded OFDM system

Space-time coding (STC) achieves diversity gain through transmit diversity. An important class of STC is the space-time block code (STBC) which is proposed by Alamouti [3] and generalized by Tarokh [7]. The employment of STBC requires the channel to be flat. Thus, OFDM is particularly suitable for employing STBC over broadband frequency selective fading channels. The STBC-OFDM system we study is depicted in Fig. 2.

In such a system, there are two transmit antennas and a number of receive antennas. For simplicity, we assume there is

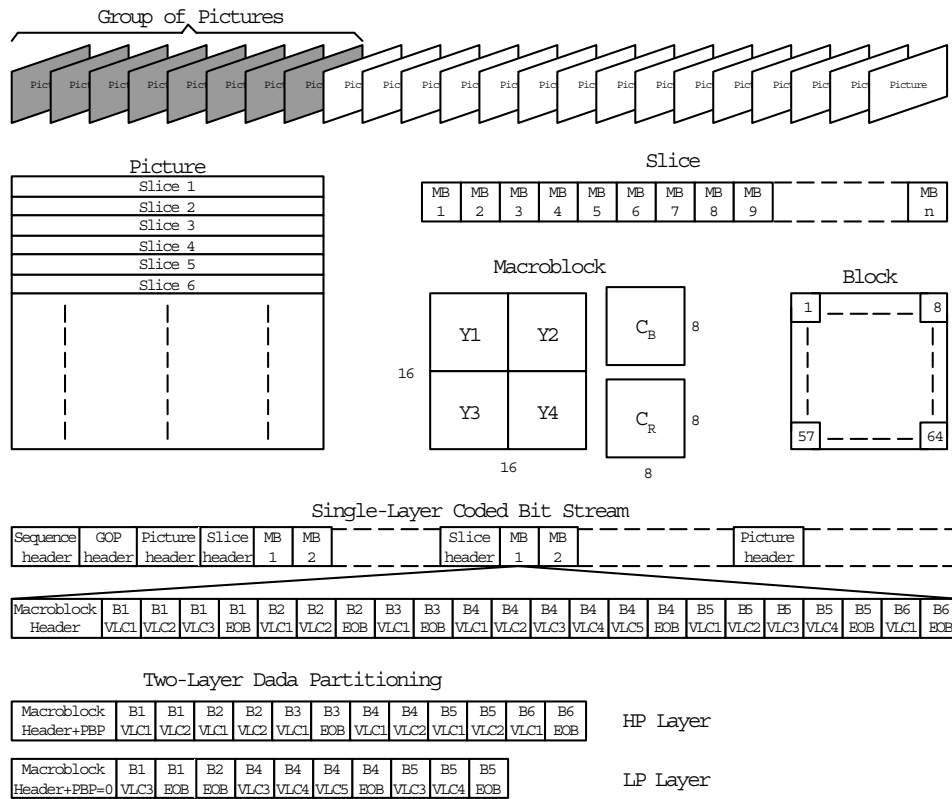

Fig. 1. Structure of MPEG data and data partitioning.

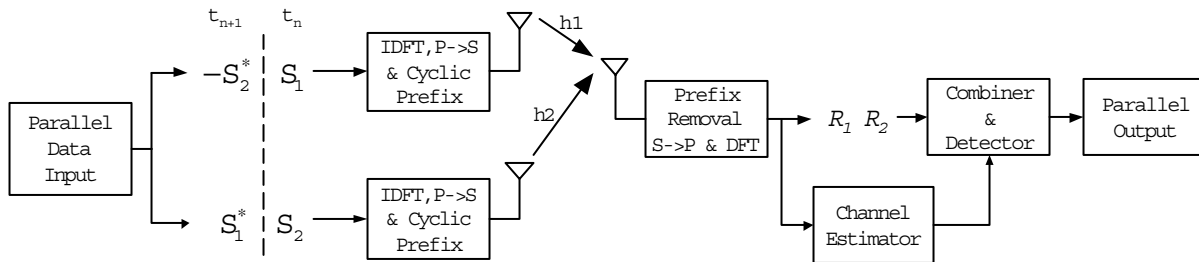

Fig. 2. An STBC-OFDM system.

one receive antenna¹. Then there are two uncorrelated multipath channels corresponding to the two transmit antennas. With the assumption of constant channel response, STBC is performed on two consecutive OFDM symbols. Let N denote the number of sub-channels in an OFDM symbol. Then the pair of OFDM symbols in an STBC block are denoted as

$$\begin{aligned} \mathbf{s}_1 &= [s_{1,1} \ s_{1,2} \ \cdots \ s_{1,N}]^T \\ \mathbf{s}_2 &= [s_{2,1} \ s_{2,2} \ \cdots \ s_{2,N}]^T \end{aligned} \quad (1)$$

where $s_{i,k}$, $i = 1, 2$, $k \in [1, \dots, N]$ is the modulated symbol on sub-channel k of OFDM symbol i , and T represents the transpose operation. The operation of STBC is given by the transmission matrix [7]

$$G_2 = \begin{pmatrix} \mathbf{s}_1 & \mathbf{s}_2 \\ -\mathbf{s}_2^* & \mathbf{s}_1^* \end{pmatrix} \quad (2)$$

¹Our scheme can be easily extended to multiple receive antennas, as well as other STBC schemes [7].

where $*$ represents the complex conjugate operation. More specifically, at the first time slot, s_1 and s_2 are transmitted simultaneously from the two transmit antennas; at the next time slot, $-s_2^*$ and s_1^* are transmitted from the two antennas, respectively.

At the receiver, the baseband received signal at the two time slots can be expressed as

$$\begin{aligned} \mathbf{R}_1 &= \mathbf{H}_1 \mathbf{s}_1 + \mathbf{H}_2 \mathbf{s}_2 + \mathbf{n}_1 \\ \mathbf{R}_2 &= -\mathbf{H}_1 \mathbf{s}_2^* + \mathbf{H}_2 \mathbf{s}_1^* + \mathbf{n}_2 \end{aligned} \quad (3)$$

where \mathbf{n}_1 and \mathbf{n}_2 are vectors of complex additive white Gaussian noise (AWGN) with zero mean and variance σ_n^2 , and $\mathbf{H}_i, i = 1, 2$ are the two channel response diagonal matrices given as

$$\mathbf{H}_i = \begin{bmatrix} H_{i,1} & & & & & \\ & H_{i,2} & & & & \\ & & \ddots & & & \\ & & & H_{i,N-1} & & \\ & & & & H_{i,N} & \end{bmatrix}, i = 1, 2 \quad (4)$$

where $H_{i,k}, i = 1, 2, k \in [1, \dots, N]$ is the channel response on the k th sub-channel of channel i . Given \mathbf{H}_1 and \mathbf{H}_2 , the decision variables are

$$\begin{aligned} \hat{s}_1 &= \mathbf{H}_1^* \mathbf{R}_1 + \mathbf{H}_2 \mathbf{R}_2^* \\ &= (\mathbf{H}_1^* \mathbf{H}_1 + \mathbf{H}_2 \mathbf{H}_2^*) \mathbf{s}_1 + \mathbf{H}_1^* \mathbf{n}_1 + \mathbf{H}_2 \mathbf{n}_2^* \\ \hat{s}_2 &= \mathbf{H}_2^* \mathbf{R}_1 - \mathbf{H}_1 \mathbf{R}_2^* \\ &= (\mathbf{H}_2^* \mathbf{H}_2 + \mathbf{H}_1 \mathbf{H}_1^*) \mathbf{s}_2 + \mathbf{H}_2^* \mathbf{n}_1 - \mathbf{H}_1 \mathbf{n}_2^* \end{aligned} \quad (5)$$

where $\hat{s}_i, i = 1, 2$ are denoted as $\hat{s}_i = [\hat{s}_{i,1} \hat{s}_{i,2} \dots \hat{s}_{i,N}]^T$. Then maximum likelihood detection is performed as

$$\arg \min_{s_{i,k} \in \mathbb{S}} \left| \hat{s}_{i,k} - s_{i,k} \right|^2 + \left(|H_{1,k}|^2 + |H_{2,k}|^2 - 1 \right) |s_{i,k}|^2, \quad i = 1, 2, k \in [1, \dots, N] \quad (6)$$

where \mathbb{S} is the set of all possible constellation symbols.

III. UEP THROUGH SUB-CHANNEL PARTITIONING

In this section, we present a detailed description of the sub-channel partitioning based UEP scheme.

A. Sub-channel Partitioning

For OFDM systems, the multipath fading channel introduces variations of channel gain on different sub-channels. Although STBC helps to reduce such variations, there are still rich fluctuations in channel gain that can be exploited, as exemplified in Fig. 3. The time domain channel responses for the two channels are plotted in Fig. 3 (a) and (b), while the corresponding frequency domain (after being squared) responses are presented in

Fig. 3 (c) and (d). Fig. 3 (e) is the composite channel response, which is the summation of the two squared frequency domain channel responses. Obviously, sub-channels can be partitioned based on the composite channel response (as discussed later, it is equivalent to partitioning based on SNR). As shown in Fig. 3 (f), sub-channels are divided into two groups. In such a partitioning, a threshold is chosen so that sub-channels with gains higher (or lower) than the threshold are assigned to the HQ (or LQ) group. The selection of such a threshold depends on the rate ratio between HP and LP coded video data. For example, when the two layers of video data have a rate ratio of 1 : 1, the threshold should be chosen as the median of the composite channel responses for all the sub-channels.

In our proposed scheme, sub-channel partitioning is performed at the receiver side based on the estimated channel information, which is essential to the decoding of STBC [3]. The group membership for each sub-channel can be indicated by a number of bits and the whole partition results can be represented by the PV. When there are two groups, a single bit is sufficient for each sub-channel. Thus, the length of the PV is equal to the number of sub-channels. The PV needs to be fed back to the transmitter for the allocation of layered video data. For STBC-OFDM systems with less than a few hundred sub-channels, such a feedback overhead is acceptable. For STBC-OFDM systems with many more sub-channels, sub-channel bundling can be applied to reduce the overhead, as discussed in Section V.

B. Frame and Burst Structure

For simplicity, we assume a base station sends video stream to a mobile user and the propagation delay is negligible². The frame structures over the downlink and uplink are illustrated in Fig. 4. The base station starts a burst cycle by sending a sequence of known OFDM symbols in a pilot burst, which is mainly used for channel estimation and synchronization. Within the burst, a parameter on the number of HQ (or LQ) sub-channels is also given, which is determined from the rate ratio between HP and LP coded video data. After estimating the channel, the mobile assigns a number of sub-channels to the HQ and LQ groups, as instructed by the transmitter. Then a PV is formed, which consists of a sequence of bits indicating the membership of each sub-channel. Here, we assume a 1 corresponds to an HQ sub-channel, and a 0 corresponds to an LQ sub-channel. The PV is sent back to the base station in feedback bursts. Then the base station starts a data burst for video transmission by loading HP data onto HQ sub-channels, and so on. Each data burst lasts for a number of OFDM symbols for transmitting an entire video data frame. Afterwards, a new

²The operation from a mobile user to a base station is identical.

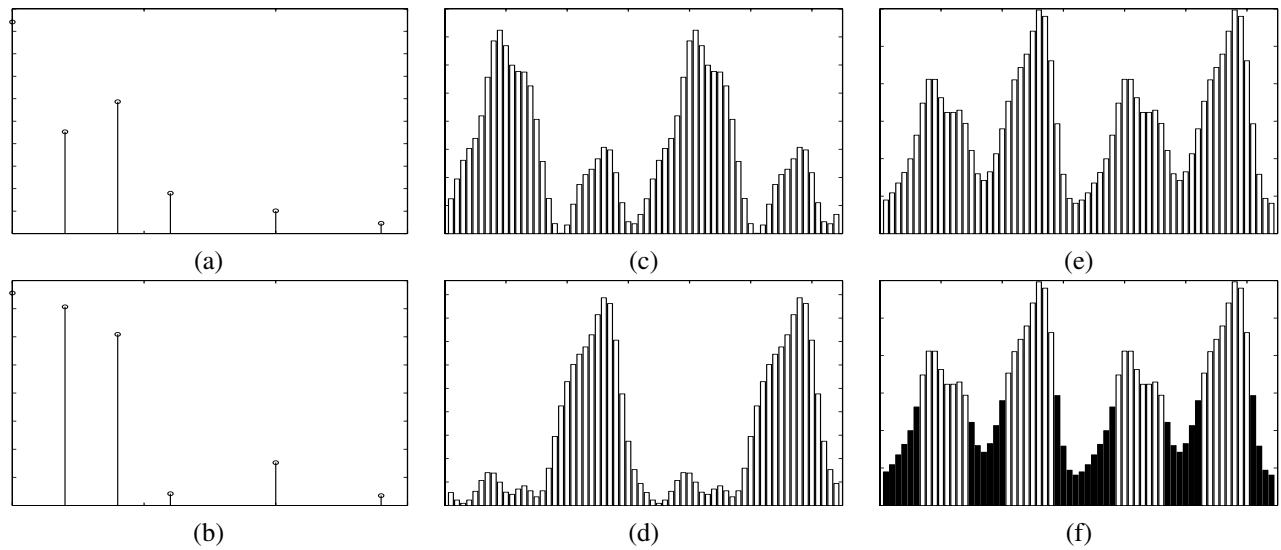

Fig. 3. An example of sub-channel partitioning. (a) time domain representation of multipath channel 1 (from transmit antenna 1 to the receive antenna): \mathbf{h}_1 ; (b) time domain representation of multipath channel 2 (from transmit antenna 2 to the receive antenna): \mathbf{h}_2 ; (c) squared frequency domain response of channel 1: $|\text{DFT}(\mathbf{h}_1)|^2$; (d) squared frequency domain response of channel 2: $|\text{DFT}(\mathbf{h}_2)|^2$; (e) composite channel response: $|\text{DFT}(\mathbf{h}_1)|^2 + |\text{DFT}(\mathbf{h}_2)|^2$; (f) sub-channel partitioning based on composite channel response.

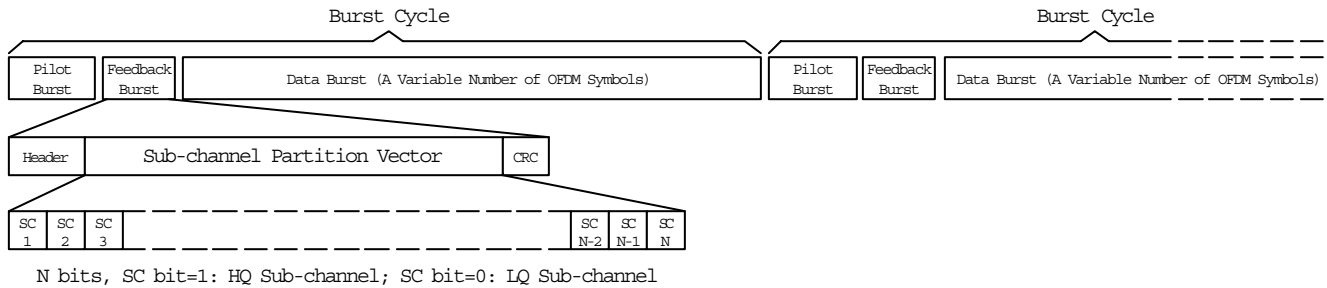

Fig. 4. Burst Structure.

cycle of operation starts by another pilot burst transmitted by the base station.

C. System Diagram

In Fig. 5, we provide the schematic of the STBC-OFDM video transmission system employing sub-channel partitioning based UEP. For illustrative simplicity, only functional blocks related to video data transmission are presented in the diagram, while pilot and feedback related blocks are omitted.

In this system, convolutional codes are concatenated with STBC, and a block interleaver is used to disperse burst errors. After mapping HP and LP data onto HQ and LQ sub-channels, the mapped data are transmitted through STBC-OFDM.

At the receiver, the data belonging to the two layers are demultiplexed from the sub-channels by using the already

existing partition information. Finally the reconstructed layered data are fed into an MPEG-2 decoder to reproduce the video sequence.

The quality of the output video is usually measured by the peak signal-to-noise ratio (PSNR)

$$PSNR = 10 \log_{10} \left(\frac{255 \times 255}{MSE} \right)$$

where

$$MSE = \frac{1}{LVH} \sum_{l=1}^L \sum_{v=1}^V \sum_{h=1}^H [X_l(v, h) - X_{l,0}(v, h)]^2$$

in which L is the total number of video frames, $V \times H$ is the video dimension, $X_{l,0}(v, h)$ is the pixel value of the error-free picture l , $X_l(v, h)$ is the pixel value of the picture l decoded at the receiver.

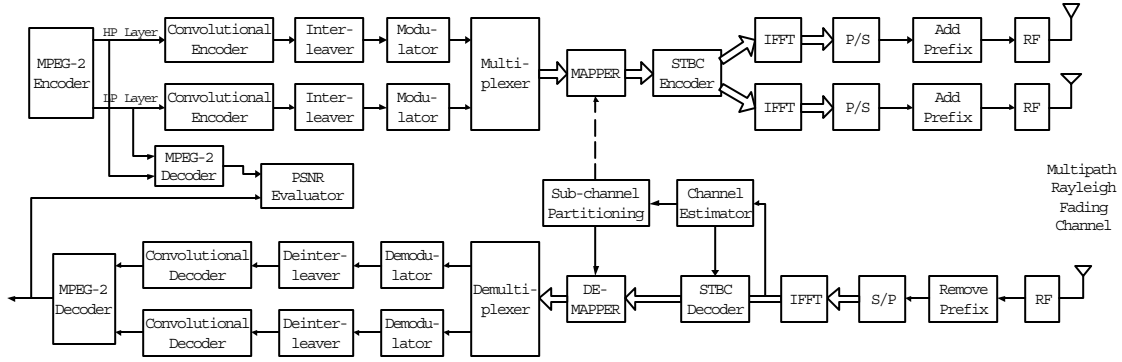

Fig. 5. System schematic.

IV. PERFORMANCE ANALYSIS AND DISCUSSION

In this section, we analyze the performance of HQ and LQ sub-channel groups, present a method for determining the proper transmission power, and discuss performance related issues.

A. Performance Analysis

We consider the case of two transmit antennas and one receive antenna. Let s_1 and s_2 be two consecutive symbols on a sub-channel k before space-time encoding³. The corresponding received symbols are given as

$$\begin{aligned} r_1 &= H_1 s_1 + H_2 s_2 + n_1 \\ r_2 &= -H_1 s_2^* + H_2 s_1^* + n_2. \end{aligned} \quad (7)$$

The decision variable for s_1 is given by⁴

$$\begin{aligned} \hat{s}_1 &= H_1^* r_1 + H_2 r_2^* \\ &= (|H_1|^2 + |H_2|^2) \cdot s_1 + H_1^* n_1 + H_2 n_2^* \end{aligned} \quad (8)$$

where n_1 and n_2 are complex AWGN with zero mean and variance σ_n^2 , H_1 and H_2 are two uncorrelated channels. We assume H_1 and H_2 are Rayleigh distributed with power E_H . Then in (8), $(|H_1|^2 + |H_2|^2) \cdot s_1$ can be viewed as the signal part, and $H_1^* n_1 + H_2 n_2^*$ the noise part. We define $X = |H_1|^2 + |H_2|^2$ as the composite sub-channel response and let E_s be the average power of data symbols. The instantaneous power of the signal part and noise part of \hat{s}_1 can be represented as $X^2 \cdot E_s$ and $X \cdot \sigma_n^2$, respectively. The instantaneous SNR can be expressed as

$$\gamma = \frac{X \cdot E_s}{\sigma_n^2}. \quad (9)$$

³For notational simplicity, we omit the sub-channel index k in all subscripts.

⁴The processing for s_2 is similar to that of s_1 and is thus omitted.

Let $\bar{\gamma} = \frac{E_H \cdot E_s}{\sigma_n^2}$ be the average SNR. Then the instantaneous SNR can be re-expressed as

$$\gamma = \frac{X \cdot \bar{\gamma}}{E_H}. \quad (10)$$

It is obvious that X follows a chi-square distribution with 4 degrees of freedom. The probability density function (pdf) of the chi-square distribution is

$$p(x) = \frac{x^{\frac{n}{2}-1} \cdot e^{-\frac{x}{2\sigma^2}}}{(2\sigma^2)^{\frac{n}{2}} \cdot \Gamma(\frac{n}{2})}, \quad x \geq 0 \quad (11)$$

where n is the freedom order, Γ is the gamma function of the form $\Gamma(\alpha) = \int_0^\infty t^{\alpha-1} \cdot e^{-t} dt$, and σ^2 is the variance of n independently and identically distributed normal random variables. Then the pdf of X is given by

$$p(x) = \frac{1}{E_H^2} x \cdot e^{-\frac{x}{E_H}}, \quad x \geq 0. \quad (12)$$

Based on (10) and (12), we have

$$p(\gamma) = \frac{\gamma}{\bar{\gamma}^2} \cdot e^{-\frac{\gamma}{\bar{\gamma}}}, \quad \gamma \geq 0. \quad (13)$$

Figure 6 shows the pdf and cumulative density function (cdf) of X (assuming $E_H = 1$). It is shown that the composite sub-channel response is distributed over a wide range. Thus, sub-channel partitioning can be performed based on the value of γ , or equivalently, on X .

In our partitioning scheme, a partition threshold on x_0 should be chosen so that sub-channels with $X \geq x_0$ are marked as HQ sub-channels and those with $X < x_0$ as LQ sub-channels. Let X_{HQ} and X_{LQ} be the random variables which correspond to the composite channel gains on HQ and LQ sub-channels, respectively. From the pdf's of X , the pdf's of X_{HQ} and X_{LQ} are obtained as

$$\begin{aligned} p_{X_{HQ}}(x) &= \frac{x \cdot e^{-x}}{(x_0+1) \cdot e^{-x_0}}, \quad x \geq x_0 \\ p_{X_{LQ}}(x) &= \frac{x \cdot e^{-x}}{1 - (x_0+1) \cdot e^{-x_0}}, \quad 0 \leq x < x_0, \end{aligned} \quad (14)$$

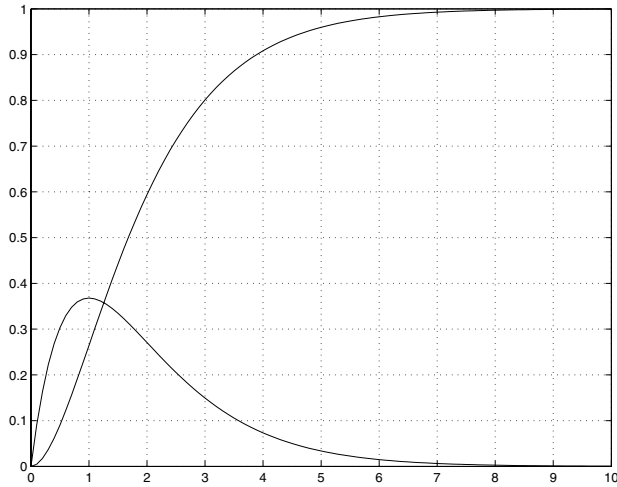

Fig. 6. pdf. and cdf. of X .

and the pdf's of the corresponding instantaneous SNR are

$$p_{\gamma,HQ}(\gamma) = \frac{\frac{\gamma}{\bar{\gamma}} \cdot e^{-\frac{\gamma}{\bar{\gamma}}}}{(\gamma_0 + \bar{\gamma}) \cdot e^{-\frac{\gamma_0}{\bar{\gamma}}}}, \gamma \geq \gamma_0 \quad (15)$$

$$p_{\gamma,LQ}(\gamma) = \frac{\frac{\gamma}{\bar{\gamma}} \cdot e^{-\frac{\gamma}{\bar{\gamma}}}}{\bar{\gamma} - (\gamma_0 + \bar{\gamma}) \cdot e^{-\frac{\gamma_0}{\bar{\gamma}}}}, 0 \leq \gamma < \gamma_0,$$

where $\gamma_0 = x_0 \cdot \bar{\gamma}$. Let $P_e(\gamma)$ be the BER at SNR γ . We could obtain the BER performance of the HQ and LQ sub-channel groups by averaging $P_e(\gamma)$ over the pdf of $p_{\gamma,HQ}(\gamma)$ and $p_{\gamma,LQ}(\gamma)$, i.e.,

$$P_{e,HQ}(\gamma_0) = \int_{\gamma_0}^{\infty} P_e(\gamma) \cdot p_{\gamma,HQ}(\gamma) d\gamma$$

$$P_{e,LQ}(\gamma_0) = \int_0^{\gamma_0} P_e(\gamma) \cdot p_{\gamma,LQ}(\gamma) d\gamma. \quad (16)$$

For a particular partition scheme, the value of x_0 is determined by the rate ratio of the HP and LP layers. Given x_0 , functions in (16) are only determined by the average SNR $\bar{\gamma}$.

Since the most vital data are contained in the HP layer, the overall video quality is mainly determined by the BER of the HP layer. Suppose we know the HP layer BER requirement $P_{e,HP}$, we can calculate the minimum required $\bar{\gamma}$ by

$$\bar{\gamma}_{min} = \arg_{\bar{\gamma}} \{P_{e,HQ}(\bar{\gamma}) = P_{e,HP}\}. \quad (17)$$

Then $\bar{\gamma}_{min}$ could be used to determine the transmission power.

Based on (16), the BER of HQ and LQ groups can be calculated. In Fig. 7, we plot the BER when QPSK is used and each group has half the number of sub-channels. The BER of QPSK in Gaussian channels is given by [8] $P_e(\gamma) = Q(\sqrt{\gamma})$, where $Q(y) = \frac{1}{\sqrt{2\pi}} \int_y^{\infty} e^{-\frac{t^2}{2}} dt$.

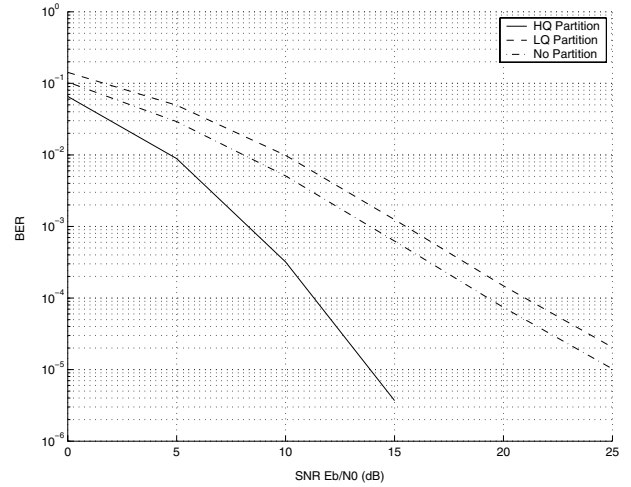

Fig. 7. Performance of different sub-channel partitions.

The above analysis and numerical results show that there are notable BER differences between HQ and LQ sub-channel partitions which could be exploited for UEP.

B. Discussions

There are three other factors that will affect the performance of the proposed scheme, namely, the channel estimation errors, frame size, and sub-channel bundle size.

In practice, channel estimation is never perfect. In [9], it is pointed out that with properly chosen pilot sequences, the channel estimation results can be viewed as the true channel attenuation values plus AWGN. In our proposed scheme, the estimation noise will not only affect STBC decoding, but also the partitioning of sub-channels. However, it can be expected that the errors in sub-channel partitioning will be insignificant when the channel estimation error is small relative to the true channel values. The more noticeable impact of channel estimation errors would be on STBC decoding. Obviously, this impact on decoding influences all schemes in the STBC-OFDM system.

Our scheme is also influenced by the data frame size. In the scheme, after sub-channels are partitioned, the partition pattern is maintained over the whole data frame for video transmission. However, the wireless channel is bound to change during the period, which would lead to performance degradations, especially for a large frame size. On the other hand, if a smaller frame size is adopted, the channel has to be estimated and partitioned more frequently, which increases system overhead.

In the previous discussion, sub-channel partitioning is performed on each sub-channel. Thus the length of the PV is at least N bits. This will produce a long feedback string for a large

TABLE I
PARAMETERS OF THE OFDM SYSTEM.

Name	Value
Number of sub-channels (N)	64
IFFT/FFT period (T_{FFT})	$3.2 \mu s$
Guard interval duration (T_{GI})	$0.8 \mu s$
Symbol interval ($T_{FFT} + T_{GI}$)	$4 \mu s$
Modulation scheme	QPSK
Convolutional coding rate	$\frac{1}{2}, \frac{1}{3}, \frac{3}{4}$

N . In order to decrease the length of the PV, we can bundle a number of neighboring sub-channels to the same group. This is a viable approach since neighboring sub-channels usually have highly correlated channel responses. Through sub-channel bundling, the feedback overhead can be significantly reduced. Perhaps a more efficient way for representing the partition pattern is through coding, such as entropy coding. However, the use of coding may be sensitive to transmission errors. More importantly, the system we consider has limited number of sub-channels, and the overhead of the bit string is tolerable. Thus we do not consider any such coding schemes in this work.

The influence of the above factors are investigated by computer simulations in Sec. V. We show that our proposed UEP scheme is more robust to channel estimation errors when compared to other video transmission schemes. It is also hardly influenced by channel variations even with large frame sizes. Further, performance degradation only becomes noticeable for large sub-channel bundle sizes.

V. SIMULATION RESULTS

In this section, the performance of the proposed scheme is evaluated by computer simulations.

A. System Parameters and Channel Model

In Table I, we list the OFDM parameters used in the simulations. They are identical to those of IEEE 802.11a [10]. Alamouti's STBC scheme [3] is employed.

The delay profile of indoor wideband channel model B (see Table II), provided in ITU-R recommendation [11], is adopted for the simulation of uncorrelated multipath Rayleigh fading channels. The Doppler frequency is fixed at 100 Hz, which corresponds to a moving speed of about 6 m/s at the 5 GHz band.

The standard video sequence 'Mobile' is used as the video source. This sequence is in the common intermediate format (CIF) with a resolution of 352×288 , and a sampling ratio of 4 : 2 : 0. We modify the constant bit rate (CBR) codec from the MPEG simulation software group [12] to realize data partitioning. The total data rate is fixed at 3 Mbps. In all simulations, video concealment is not used.

TABLE II
ITU-R M.1225 INDOOR B CHANNEL MODEL.

Tap	Relative Delay (ns)	Average Power (dB)
1	0	0
2	100	-3.6
3	200	-7.2
4	300	-10.8
5	500	-18
6	700	-25.2

TABLE III
PARAMETERS OF DIFFERENT SCHEMES.

Index	Scheme	HP FEC	LP FEC
1	two-layer sub-channel partitioning based UEP	$\frac{1}{2}$	$\frac{1}{2}$
2	two-layer FEC-based UEP	$\frac{1}{3}$	No FEC
3	single-layer		$\frac{1}{2}$

B. Simulation Results

1) *Performance Comparison:* We compare the performance of three schemes. Besides the sub-channel partitioning based UEP, we also evaluate a single-layer scheme and a two-layer data partitioning scheme with FEC-based UEP. The parameters of the three schemes are listed in Table III. The scheme index number will be used in the following parts for convenience. The video data frame size is 10 OFDM symbols for all the schemes. For the two data partitioning schemes, the bit streams of the two layers have a rate ratio of 1 : 1. FEC rates are chosen such that the total transmission data rate is identical for all the schemes after coding.

Fig. 8 presents the PSNR performance against E_b/N_0 for the three schemes. We observe that our proposed scheme has the best performance for all SNR values. The performance gap widens with the increase of SNR. At an SNR of 16 dB, our scheme has at least a PSNR gain of 10 dB compared to the other two schemes.

Scheme 2 has the second best performance among all the schemes. This shows the ability of UEP to enhance performance. As expected, Scheme 3 has the worst performance.

2) *Influence of STBC and Multiple Antennas:* Since Schemes 1 and 2 have the best performance among all three schemes, we will just consider these two schemes. In Fig. 9, performance of the following system configurations are compared: 1) an OFDM system without STBC (one transmit antenna and one receive antenna); 2) STBC-OFDM employing two transmit antennas and one receive antenna; 3) STBC-OFDM with two antennas at both sides.

The PSNR performance of all the configurations are pre-

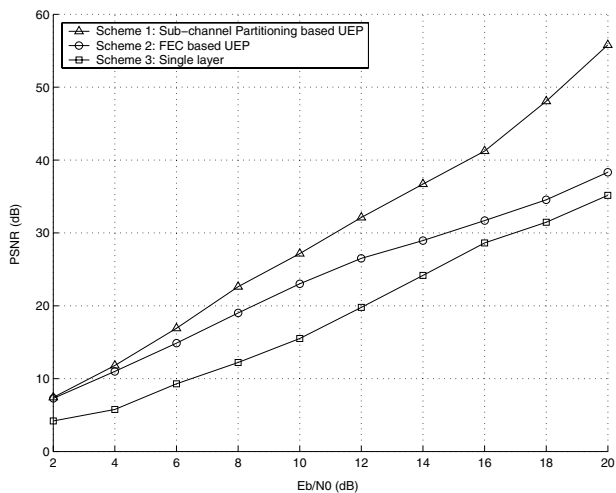
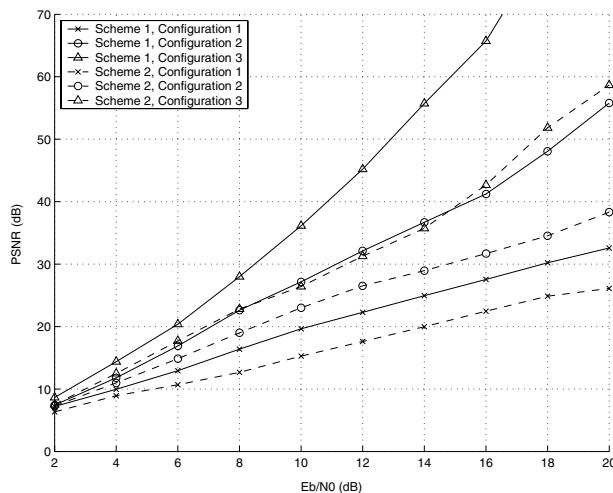

Fig. 8. PSNR performance of different schemes.

sented in Fig. 9 (a). The improvement due to STBC is dramatic. For each scheme, according to the BER trend [3], the performance improves as the configuration goes from 1) to 2) to 3), as expected. Further, our proposed UEP scheme has better performance than FEC-based UEP scheme for all the cases. We notice the performance of sub-channel partitioning based UEP with two transmit antennas and only one receive antenna has almost the same performance as the FEC-based UEP with two antennas at both sides. Thus, if the proposed UEP scheme is employed, similar performance could be achieved by saving one antenna at the mobile.

In Fig. 9 (b), we plot the performance enhancement between two consecutive configurations for the same UEP scheme. When comparing the same two configurations, we observe that the enhancement for Scheme 1 is always higher than that of Scheme 2. For example, comparing the enhancement of changing the configuration from 1) to 2), at an SNR of 16 dB, the PSNR enhancement for Scheme 1 is about 14 dB, and only 9 dB for Scheme 2. More interestingly, the gap between the two UEP schemes becomes more dramatic when the number of receive antennas is increased from 1 to 2. For example, at an SNR of 16 dB, the enhancement is about 23 dB for Scheme 1, and 11 dB for Scheme 2. This shows that with two receive antennas, our proposed scheme achieves a larger performance enhancement than the FEC-based UEP scheme.

3) *Impact of Channel Estimation Errors:* In previous simulations, channel estimation is assumed perfect. Now we study the performance when the channel estimation may be erroneous. According to [9], channel estimation errors can be modeled as AWGN on the frequency domain channel response. In the simulation, the channel estimation error is characterized



(a)

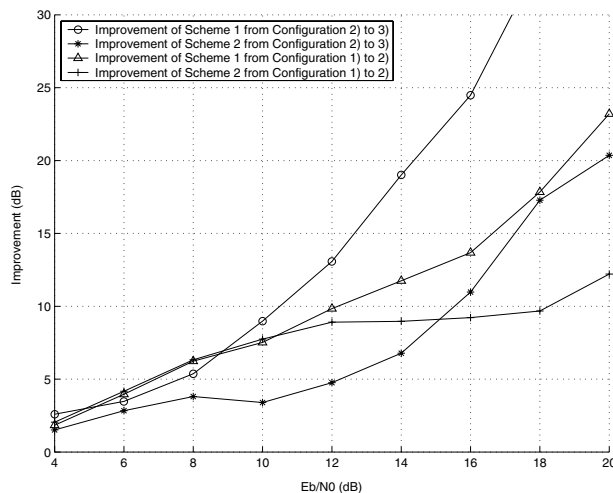

(b)

Fig. 9. Influence of STBC and the number of receive antennas. (a) PSNR performance of different schemes for different configurations; (b) PSNR improvement of different schemes for different configurations.

by the ratio between the average power of the real channel gain and the error variance, which is termed channel signal-to-noise ratio (CSNR). Then we compare the impacts of channel estimation errors on our scheme and the FEC-based UEP. The data ratio between the HP layer and LP layer is 2 : 3, and the FEC coding rates are $\frac{1}{2}$ and $\frac{3}{4}$ for HP and LP layers, respectively.

Fig. 10 (a) is the PSNR performance of the schemes with different CSNRs. The results in Fig. 10 (a) are then normalized by the corresponding PSNR values with perfect channel

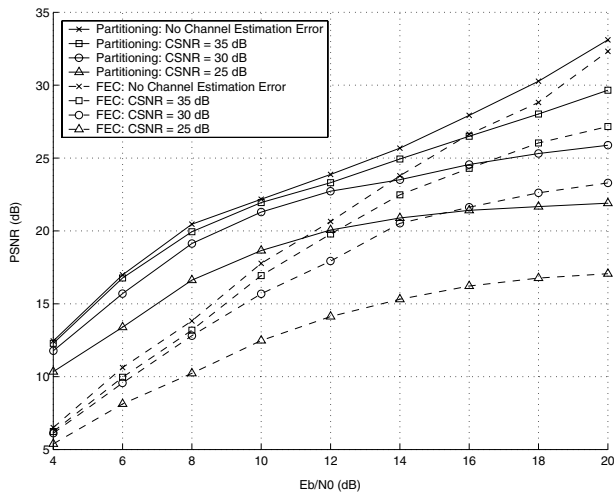

(a)

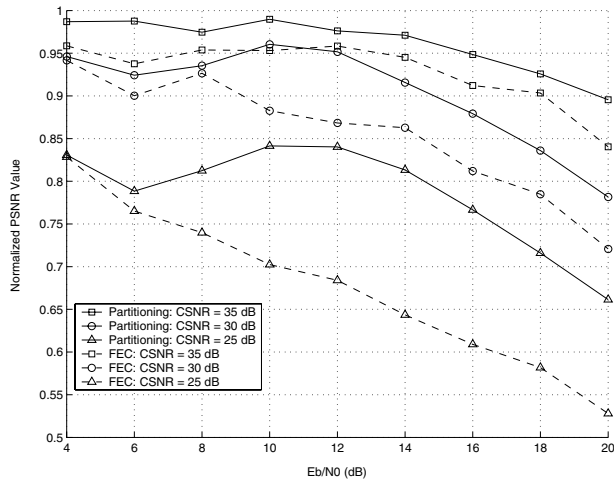

(b)

Fig. 10. Impact of channel estimation errors. (a) PSNR performance of different schemes with different CSNRs; (b) Normalized PSNR Performance of different schemes with different CSNRs.

estimation, and are plotted in Fig. 10 (b). From Fig. 10 (b), we can conclude that our proposed sub-channel partitioning based UEP is more robust against channel estimation errors than the FEC-based UEP scheme.

4) *Impact of Frame Size:* As discussed in Section IV-B, the frame size for an OFDM symbol trades off the ability to adapt to channel variation and the channel estimation overhead.

The rate of channel variation is determined by the Doppler frequency. In the simulation, a Doppler frequency of 100 Hz is used. The performance results for frame sizes of 2, 10, 40, and 100 are presented in Fig. 11, from which we can observe

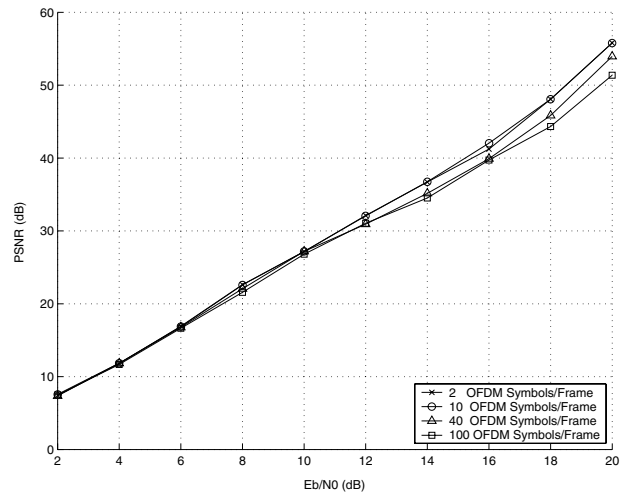

Fig. 11. PSNR performance for different frame sizes.

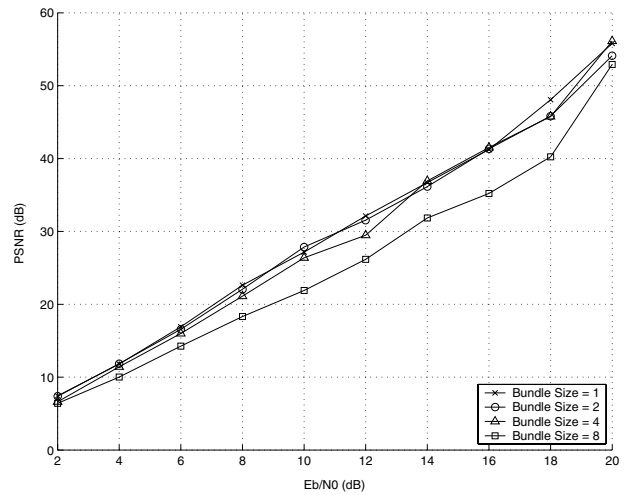

Fig. 12. PSNR performance for different sub-channel bundle sizes.

that there is negligible performance degradation even for data frame size as large as 100. This indicates the proposed system is robust to channel variation and a large frame size could be used for less channel estimation overhead and better efficiency.

5) *Sub-channel Bundling:* We evaluate the performance of our proposed UEP scheme when 1, 2, 4, and 8 sub-channels are bundled to reduce the overhead in the feedback message. Simulation results are shown in Fig. 12, from which we find that the degradation due to sub-channel bundling is very limited for a bundle size up to 4, while there is noticeable performance degradation for a bundle size of 8. Thus, a bundle size of 4 is a good choice of trade off between performance and efficiency.

VI. CONCLUSION

In this paper, we propose a sub-channel partitioning based UEP scheme for wireless video transmission in STBC-OFDM systems. This scheme achieves better performance than other known UEP schemes, with minimal additional complexity and overhead. The performance gain is even more significant when there are two receive antennas. Further, the scheme is shown to be robust to channel estimation errors and channel variations. The feedback overhead can be greatly reduced by selecting an appropriate data frame size and sub-channel bundle size with very limited performance degradation.

ACKNOWLEDGMENT

The work described in this paper was partially supported by a grant from the Research Grants Council of the Hong Kong Special Administrative Region, China (Project No. HKU 7047/00E).

REFERENCES

- [1] L.M. Correia, R. Prasad, "An overview of wireless broadband communications," *IEEE Commun. Mag.*, Vol. 35, No. 1, pp. 28-33, Jan. 1997.
- [2] J.A.C. Bingham, "Multicarrier modulation for data transmission: an idea whose time has come," *IEEE Commun. Mag.*, Vol. 28, No. 5, pp. 5-14, May 1990.
- [3] S.M. Alamouti, "A simple transmit diversity technique for wireless communications," *IEEE J. Select. Areas Commun.*, Vol. 16, No. 8, pp. 1451-1458, Oct. 1998.
- [4] D.G. Daut, J.W. Modestino, "Two-dimensional DPCM image transmission over fading channels," *IEEE Trans. Commun.*, Vol. 31, No. 3, pp. 315-328, Mar. 1983.
- [5] Y. Hashimoto, S. Sampei, N. Morinaga, "Channel monitor-based unequal error protection with dynamic OFDM subcarrier assignment for video transmission," *IEEE Proc. VTC'2002-Fall*, Vol. 2, Sept. 2002, pp. 913-917.
- [6] ISO/IEC 13818-2, Recommendation ITU-T H.262, 1995.
- [7] V. Tarokh, H. Jafarkhani, A.R. Calderbank, "Space-time block codes from orthogonal designs," *IEEE Trans. Inform. Theory*, Vol. 45, No. 5, pp. 1456-1467, July 1999.
- [8] John G. Proakis, *Digital Communications*, 4th Edition, New York: McGraw-Hill, 2001.
- [9] Y. Li, N. Seshadri, S. Ariyavisitakul, "Channel estimation for OFDM systems with transmitter diversity in mobile wireless channels," *IEEE J. Select. Areas Commun.*, Vol. 17, No. 3, pp. 461-471, Mar. 1999.
- [10] IEEE Std 802.11a-1999, "Part 11: Wireless LAN medium access control (MAC) and physical layer (PHY) specifications: High-speed physical layer in the 5 GHz band," ISO/IEC 8802-11:1999/Amd 1:2000(E), 1999.
- [11] ITU-R Recommendation, ITU-R M.1225, "Guidelines for evaluation of radio transmission technologies for IMT-2000."
- [12] MPEG-2 encoder and decoder, from MPEG Software Simulation Group (MSSG), available at <http://www.mpeg.org/MPEG/MSSG/#source>.