

GP2D02

Compact, High Sensitive Distance Measuring Sensor

■ Features

1. Impervious to color and reflectivity of reflective object
2. High precision distance measurement output for direct connection to microcomputer
3. Low dissipation current at OFF-state
(dissipation current at OFF-state : TYP. 3 μ A)
4. Capable of changing of distance measuring range through change the optical portion (lens)

■ Applications

1. Sanitary sensors
2. Human body sensors for consumer products such as electric fans and air conditioners
3. Garage sensors

* PSD : Position Sensitive Detector

■ Outline Dimensions

(Unit : mm)

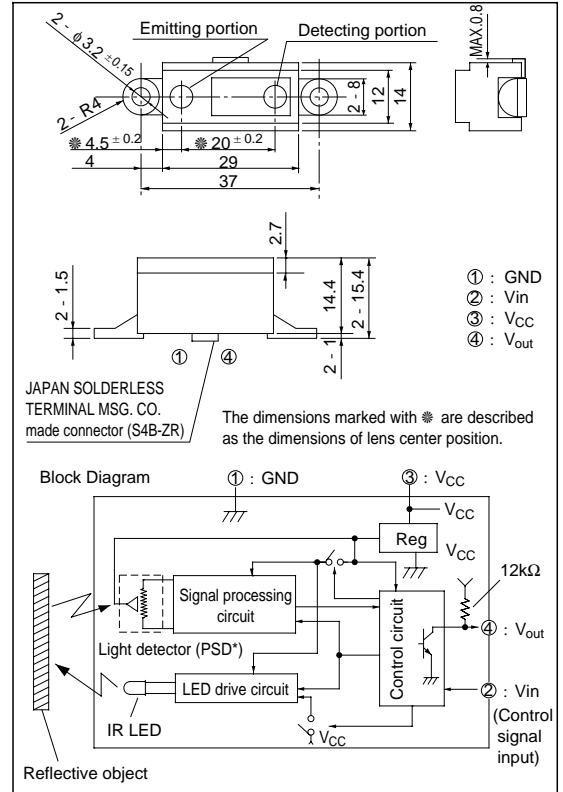

■ Absolute Maximum Ratings (Ta=25°C, V_{CC}=5V)

Parameter	Symbol	Rating	Unit
Supply voltage	V_{CC}	- 0.3 to + 10	V
*1 Input terminal voltage	V_{in}	- 0.3 to + 3	V
Output terminal voltage	BV_O	- 0.3 to + 10	V
Operating temperature	T_{opr}	- 10 to + 60	°C
Storage temperature	T_{stg}	- 40 to + 70	°C

*1 Open drain operation input

■ Operating Supply Voltage

Symbol	Rating	Unit
V_{CC}	4.4 to 7	V

Electro-optical Characteristics

(Ta=25°C, Vcc=5V)

Parameter	Symbol	Conditions	MIN.	TYP.	MAX.	Unit
Distance measuring range	ΔL	*1	10	-	80	cm
Output terminal voltage	V_{OH}	Output voltage at High L = 20cm	$V_{CC} - 0.3$	-	-	V
	V_{OL}	Output voltage at Low *1	-	-	0.3	V
Distance characteristics of output	D	L = 80cm, *1	-	75	-	DEC
	ΔD	Output change at L=80 cm to 20 cm, *1	48	58	68	DEC
Dissipation current	at operating	I_{CC} L = 20cm, *1, *2	-	22	35	mA
	at OFF-state	I_{off} L = 20cm, *1	-	3	8	μA
Vin terminal current	I_{vin}	Vin = 0V	-	- 170	- 280	μA

Note) L : Distance to reflective object

DEC : Decimalized value of sensor output (8-bit serial)

*1 Reflective object : White paper (reflectivity : 90%)

*2 Average dissipation current value during distance measuring operation when detecting of input signal, Vin as shown in the timing chart

*3 Vin terminal : Open drain drive input.

Conditions : Vin terminal current at Vin OFF-state : -1 μA

Vin terminal current at Vin ON-state : 0.3V

Test Circuit

1. Test circuit

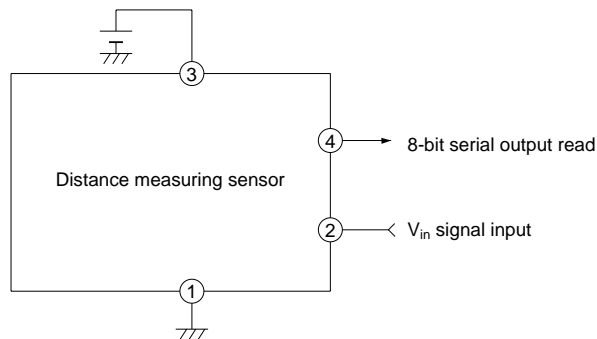

2. Vin input signal for measurement

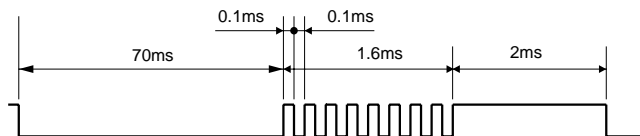

■ Timing Chart

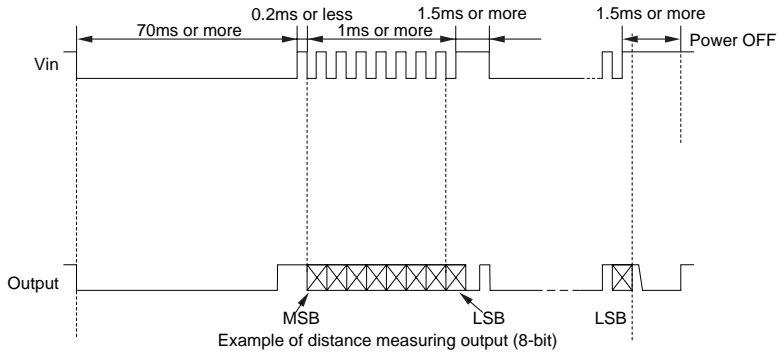

Fig. 1 Distance Measuring Output vs. Distance to Reflective Object

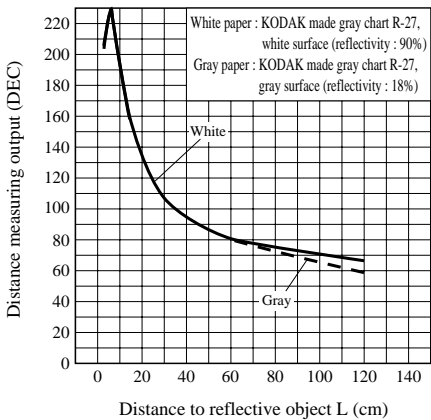
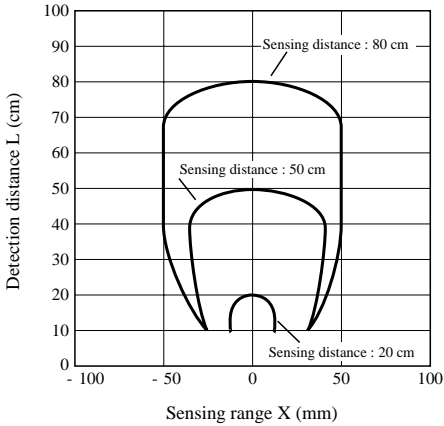

Fig. 2 Detection Distance vs. Sensing Range



Test Method for Sensing Range Characteristics

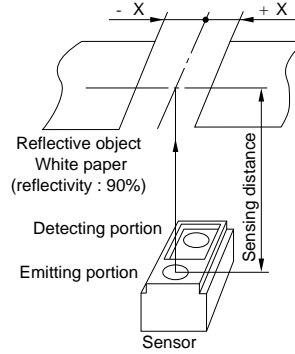
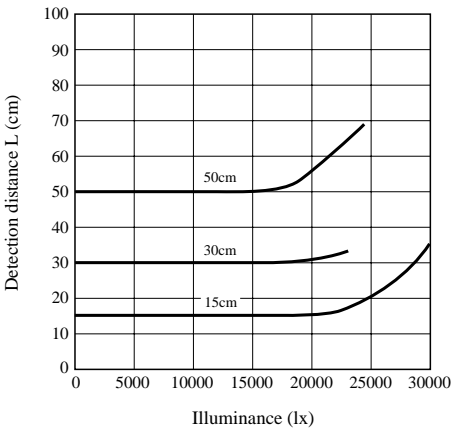

Fig. 3 Detection Distance vs. Illuminance



Test Method for Anti External Disturbing Light Characteristics

