

Dimensions: mm (In.)

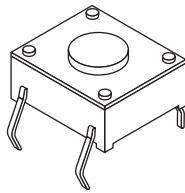

101-0161-EV

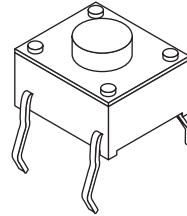

101-0261-EV

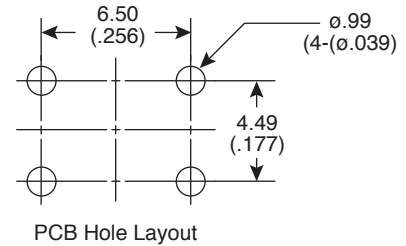
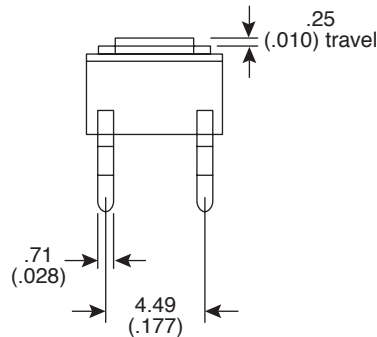
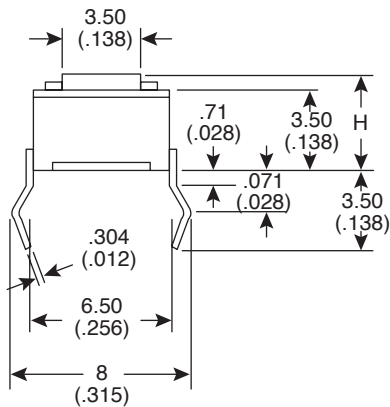
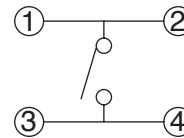
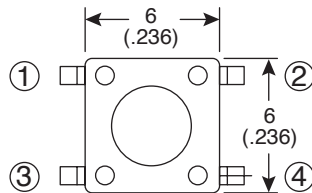

Electrical Specifications:

- Rating: 50mA/12VDC
- Insulation resistance: >100MΩ @ 250VDC
- Dielectric Strength: 250VAC for 1 minute
- Contact resistance: <100mΩ
- Electrical life: 300,000 cycles

Mechanical Specifications:

- Type: SPST
- Mechanical life: 500,000 cycles
- Temperature: -25°~+70°C
- Operating force: 130 ±50gf

Materials:

- Contacts: silver plated phosphor bronze
- Button color: black

Note:

- H: .169" (101-0161-EV), .197" (101-0261-EV)
- RoHS Compliant

Tactile Switches (Thru-Hole)

101-0161-EV, 101-0261-EV

