

74LCX14

Low Voltage Hex Inverter with 5V Tolerant Schmitt Trigger Inputs

General Description

The LCX14 contains six inverter gates each with a Schmitt trigger input. They are capable of transforming slowly changing input signals into sharply defined, jitter-free output signals. In addition, they have a greater noise margin than conventional inverters.

The LCX14 has hysteresis between the positive-going and negative-going input thresholds (typically 1.0V) which is determined internally by transistor ratios and is essentially insensitive to temperature and supply voltage variations.

The inputs tolerate voltages up to 7V allowing the interface of 5V systems to 3V systems.

Features

- 5V tolerant inputs
- 6.5 ns t_{PD} max, 10 μ A I_{CCQ} max
- Power-down high impedance inputs and outputs
- Supports live insertion/withdrawal
- 2.0V–3.6V V_{CC} supply operation
- ± 24 mA output drive
- Implements patented Quiet Series™ noise/EMI reduction circuitry
- Functionally compatible with 74 series 14
- Latch-up performance exceeds 500 mA
- ESD performance:
 - Human body model > 2000V
 - Machine model > 200V

Logic Symbol

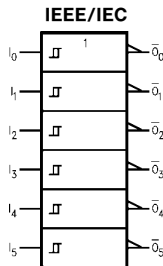

TL/F/12412-1

Connection Diagram

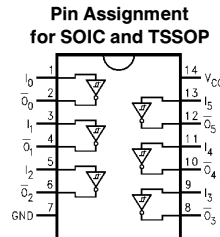

TL/F/12412-2

Pin Names	Description
I_n	Inputs
O_n	Outputs

Truth Table

Input	Output
A	\bar{O}
L	H
H	L

	SOIC JEDEC	SOIC EIAJ	TSSOP
Order Number	74LCX14M 74LCX14MX	74LCX14SJ 74LCX14SJX	74LCX14MTC 74LCX14MTCX
See NS Package Number	M14A	M14D	MTC14

Quiet Series™ is a trademark of National Semiconductor Corporation.

Absolute Maximum Ratings (Note 1)

If Military/Aerospace specified devices are required, please contact the National Semiconductor Sales Office/Distributors for availability and specifications.

Symbol	Parameter	Value	Conditions	Units
V_{CC}	Supply Voltage	-0.5 to +7.0		V
V_I	DC Input Voltage	-0.5 to +7.0		V
V_O	DC Output Voltage	-0.5 to $V_{CC} + 0.5$	Output in High or Low State (Note 2)	V
I_{IK}	DC Input Diode Current	-50	$V_I < \text{GND}$	mA
I_{OK}	DC Output Diode Current	-50 +50	$V_O < \text{GND}$ $V_O > V_{CC}$	mA
I_O	DC Output Source/Sink Current	± 50		mA
I_{CC}	DC Supply Current per Supply Pin	± 100		mA
I_{GND}	DC Ground Current per Ground Pin	± 100		mA
T_{STG}	Storage Temperature	-65 to +150		°C

Note 1: The Absolute Maximum Ratings are those values beyond which the safety of the device cannot be guaranteed. The device should not be operated at these limits. The parametric values defined in the "Electrical Characteristics" table are not guaranteed at the Absolute Maximum Ratings. The "Recommended Operating Conditions" table will define the conditions for actual device operation.

Note 2: I_O Absolute Maximum Rating must be observed.

Recommended Operating Conditions

Symbol	Parameter	Min	Max	Units	
V_{CC}	Supply Voltage	Operating Data Retention	2.0 1.5	3.6 3.6	V
V_I	Input Voltage	0	5.5	V	
V_O	Output Voltage	HIGH or LOW State	0	V_{CC}	V
I_{OH}/I_{OL}	Output Current	$V_{CC} = 3.0V - 3.6V$ $V_{CC} = 2.7V$		± 24 ± 12	mA
T_A	Free-Air Operating Temperature	-40	85	°C	

DC Electrical Characteristics

Symbol	Parameter	Conditions	V_{CC} (V)	$T_A = -40^\circ\text{C to } +85^\circ\text{C}$		Units
				Min	Max	
V_{t+}	Positive Input Threshold		3.0	1.2	2.2	V
V_{t-}	Negative Input Threshold		3.0	0.6	1.5	V
V_H	Hysteresis		3.0	0.4	1.2	
V_{OH}	HIGH Level Output Voltage	$I_{OH} = -100 \mu\text{A}$	2.7-3.6	$V_{CC} - 0.2$		V
		$I_{OH} = -12 \text{ mA}$	2.7	2.2		V
		$I_{OH} = -18 \text{ mA}$	3.0	2.4		V
		$I_{OH} = -24 \text{ mA}$	3.0	2.2		V
V_{OL}	LOW Level Output Voltage	$I_{OL} = 100 \mu\text{A}$	2.7-3.6		0.2	V
		$I_{OL} = 12 \text{ mA}$	2.7		0.4	V
		$I_{OL} = 16 \text{ mA}$	3.0		0.4	V
		$I_{OL} = 24 \text{ mA}$	3.0		0.55	V
I_I	Input Leakage Current	$0 \leq V_I \leq 5.5V$	2.7-3.6		± 5.0	μA
I_{OFF}	Power-Off Leakage Current	V_I or $V_O = 5.5V$	0		10	μA
I_{CC}	Quiescent Supply Current	$V_I = V_{CC}$ or GND	2.7-3.6		10	μA
		$3.6V \leq V_I, V_O \leq 5.5V$	2.7-3.6		± 10	μA
ΔI_{CC}	Increase in I_{CC} per Input	$V_{IH} = V_{CC} - 0.6V$	2.7-3.6		500	μA

AC Electrical Characteristics

Symbol	Parameter	$T_A = -40^{\circ}\text{C to } +85^{\circ}\text{C}$				Units
		$V_{CC} = 3.3\text{V} \pm 0.3\text{V}$		$V_{CC} = 2.7\text{V}$		
		Min	Max	Min	Max	
t_{PHL} t_{PLH}	Propagation Delay	1.5	6.5	1.5	7.5	ns
t_{OSLH} t_{OSHL}	Output to Output Skew (Note 3)		1.0			ns

Note 3: Skew is defined as the absolute value of the difference between the actual propagation delay for any two separate outputs of the same device. The specification applies to any outputs switching in the same direction, either HIGH to LOW (t_{OSHL}) or LOW to HIGH (t_{OSLH}).

Dynamic Switching Characteristics

Symbol	Parameter	Conditions	V_{CC} (V)	$T_A = 25^{\circ}\text{C}$	Units
				Typical	
V_{OLP}	Quiet Output Dynamic Peak V_{OL}	$C_L = 50\text{ pF}, V_{IH} = 3.3\text{V}, V_{IL} = 0\text{V}$	3.3	0.8	V
V_{OLV}	Quiet Output Dynamic Valley V_{OL}	$C_L = 50\text{ pF}, V_{IH} = 3.3\text{V}, V_{IL} = 0\text{V}$	3.3	-0.8	V

Capacitance

Symbol	Parameter	Conditions	Typical	Units
C_{IN}	Input Capacitance	$V_{CC} = \text{Open}, V_I = 0\text{V or } V_{CC}$	7	pF
C_{OUT}	Output Capacitance	$V_{CC} = 3.3\text{V}, V_I = 0\text{V or } V_{CC}$	8	pF
C_{PD}	Power Dissipation Capacitance	$V_{CC} = 3.3\text{V}, V_I = 0\text{V or } V_{CC}, F = 10\text{ MHz}$	25	pF

74LCX14 Ordering Information

The device number is used to form part of a simplified purchasing code where the package type and temperature range are defined as follows:

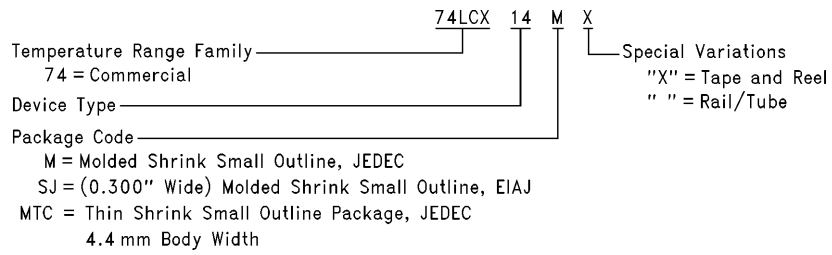

TL/F/12412-3

Physical Dimensions inches (millimeters) unless otherwise noted

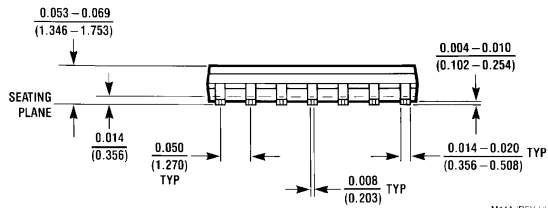
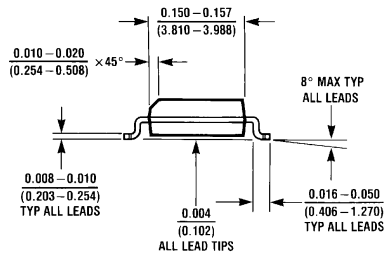
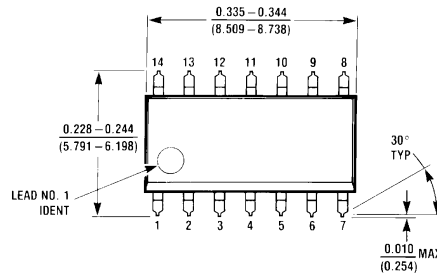

M14A (REV H)

14-Lead Molded Small Outline Package, JEDEC
Order Number 74LCX14M or 74LCX14MX
NS Package Number M14A

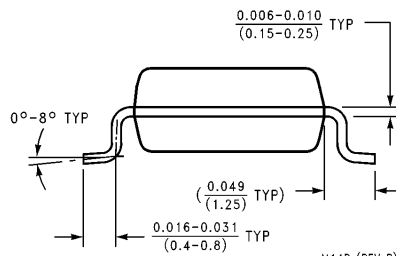
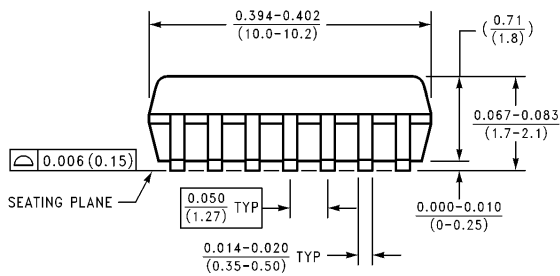
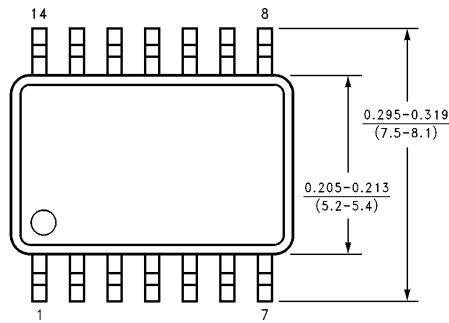

M14D (REV B)

14-Lead Small Outline Package EIAJ (SJ)
Order Number 74LCX14SJ or 74LCX14SJX
NS Package Number M14D

Physical Dimensions All dimensions are in millimeters (Continued)

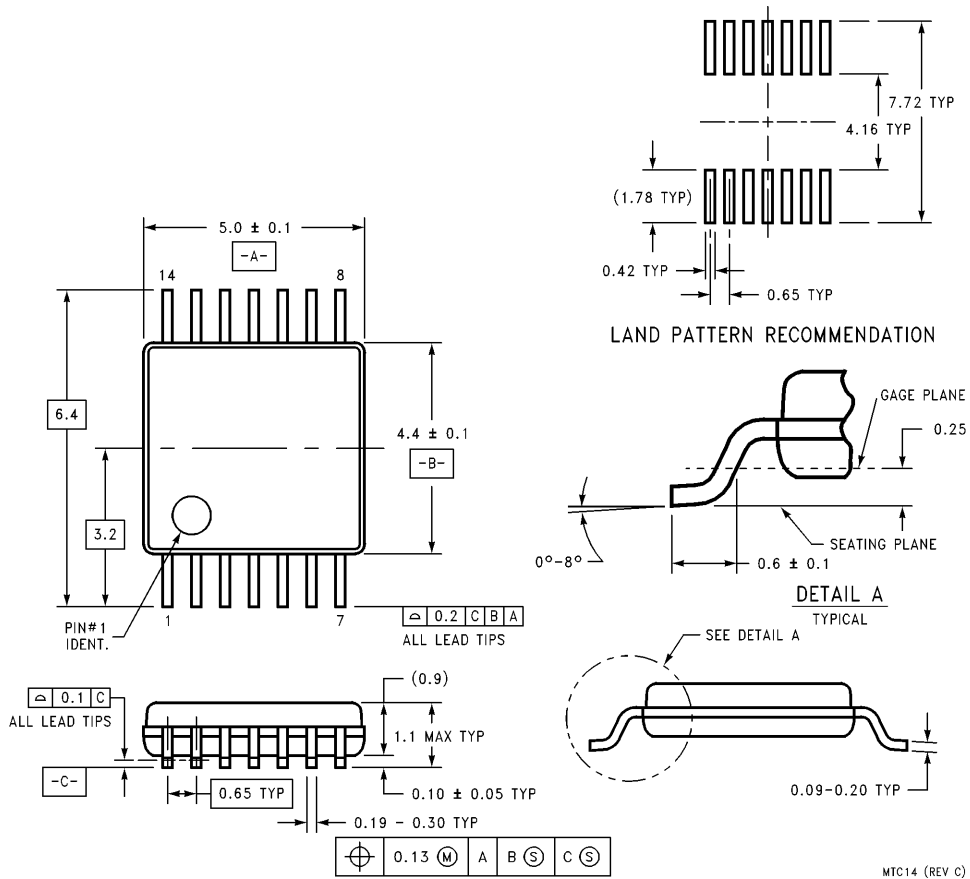

14-Lead Thin Shrink Small Outline Package (MTC)
Order Number 74LCX14MTC or 74LCX14MTCX
NS Package Number MTC14

LIFE SUPPORT POLICY

NATIONAL'S PRODUCTS ARE NOT AUTHORIZED FOR USE AS CRITICAL COMPONENTS IN LIFE SUPPORT DEVICES OR SYSTEMS WITHOUT THE EXPRESS WRITTEN APPROVAL OF THE PRESIDENT OF NATIONAL SEMICONDUCTOR CORPORATION. As used herein:

1. Life support devices or systems are devices or systems which, (a) are intended for surgical implant into the body, or (b) support or sustain life, and whose failure to perform, when properly used in accordance with instructions for use provided in the labeling, can be reasonably expected to result in a significant injury to the user.
2. A critical component is any component of a life support device or system whose failure to perform can be reasonably expected to cause the failure of the life support device or system, or to affect its safety or effectiveness.

	National Semiconductor Corporation Americas Tel: 1(800) 272-9959 Fax: 1(800) 737-7018 Email: support@nsc.com	National Semiconductor Europe Fax: +49 (0) 180-530 85 86 Email: europe.support@nsc.com Deutsch Tel: +49 (0) 180-530 85 85 English Tel: +49 (0) 180-532 78 32 Français Tel: +49 (0) 180-532 93 58 Italiano Tel: +49 (0) 180-534 16 80	National Semiconductor Southeast Asia Fax: (852) 2376 3901 Email: sea.support@nsc.com	National Semiconductor Japan Ltd. Tel: 81-3-5620-7561 Fax: 81-3-5620-6179
	http://www.national.com			
	National does not assume any responsibility for use of any circuitry described, no circuit patent licenses are implied and National reserves the right at any time without notice to change said circuitry and specifications.			