

SX28AC EMI Evaluation: EMI Results and PCB Design Considerations



Application Note 3

Abdul Aleaf

November 2000

1.0 INTRODUCTION

This report provides a summary of the EMI results for the SX28AC. An independent EMI lab that specializes in EMI testing has taken all the measurements. Based on the results obtained, an analysis of the data is provided and overall PCB design guidelines are given so that the designer can minimize EMI before it becomes a problem.

1.1 Test Types

- Radiate Emissions
- Radiated Susceptibility

1.2 Package Types

- 28-pin SOIC
- 28-pin SDIP

The footprints for both packages were laid out on the same PCB to get an accurate comparison of the EMI data between the two packages.

1.3 Device Operating Frequency

Measurements were taken using 4 MHz, 12 MHz, and 50 MHz resonators.

2.0 RADIATED EMISSION RESULTS

The SAE J1752 Integrated Circuit Radiated Emissions Measurement Procedure was used to obtain the SX emissions results. This procedure tailors the measurements for an IC (specifically a microcontroller). This SAE Recommended Practice defines a method for measuring the electromagnetic radiation from an integrated circuit. The method uses a standardized IC test board containing the IC being evaluated mounted to a mating port cut in the top or bottom of a 1 GHz TEM cell. One of the TEM cell feeds is terminated with a 50-ohm load and the other one is connected to the input of a spectrum analyzer, which measures the RF emissions over the frequency range of 150 KHz to 1000 MHz.

2.1 Standardized IC Test Board

This special square PCB includes a ground plane, which serves as a shield; the periphery of this shield is tinned to facilitate contact to the edge of the mating hole cut in the top or bottom of the TEM cell. The top side of this board that is inside the test cell is fully shielded except for the IC being evaluated and a narrow strip of vias around the IC. Other required components (such as a resonator) are

located on the other (bottom) side of this board. All SX I/O pins are terminated with 10 K resistors to Vdd and 50 pF capacitors to Vss. The board is laid out to accommodate 28-pin SOIC and 28-pin SDIP packages as well as different oscillator types.

2.2 EMI Test Code

The test routine implements a counter function using a single 8-bit port. Every 100 us, the port output is incremented. After 10 count cycles (256 ms) an LED output is toggled. For consistency, equivalent loop times are maintained (used in European IC Emission Testing). Figure 1 shows the test code flowchart.

2.3 Test Equipment and Conditions

Table 1 shows the completed SAE J1752/3 datasheet.

2.4 Emission Levels

Figures 3 - 6 shows the emission levels for different frequencies and package types.

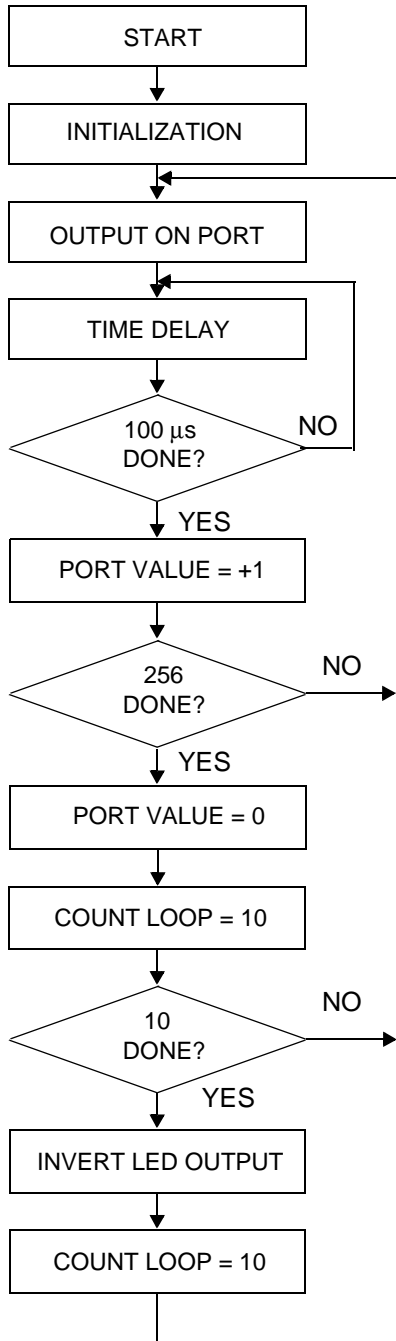

Table 1. Integrated Circuit Radiated Emissions Measurement Procedure (SAE J1752/3 Issued MAR95) 150 kHz to 1 GHz, TEM CELL

SAE J1752/3 DATA SHEET	
TEM cell used:	CE Asst 3274
VSWR OK to 1 GHz:	OK
Spectrum analyzer used:	CE Asst# 3053
Cal. OK to 1 GHz:	OK
Resolution Bandwidth (RBW):	See setup printout
Video Bandwidth (VBW):	See setup printout
Pre-amp model:	HP 8447D Ass# 3031
Gain: Cal. OK to 1 GHz:	OK
coax cable type and approx. length:	15' Cal to 1GHz
50 ohm termination for TEM cell verified to 1 GHz:	OK
System gain check (without the TEM cell)	OK
Ambient noise floor level:	-10 dBuV
Ambient temperature:	See Data
IC supply voltage:	5V
Power supply or battery	Power Supply
Type of software used to exercise the IC:	Per SAE J1752/3 test code

Figure 1. Test Code Flowchart

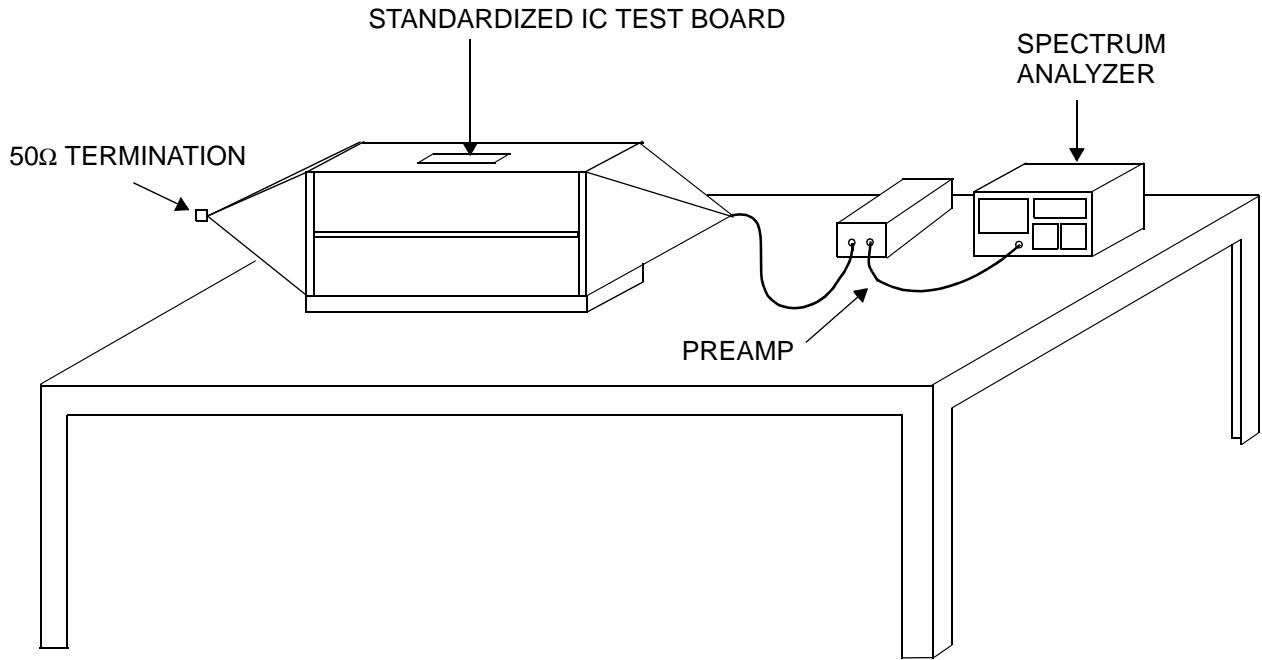

Figure 2. TEM Cell Set Up

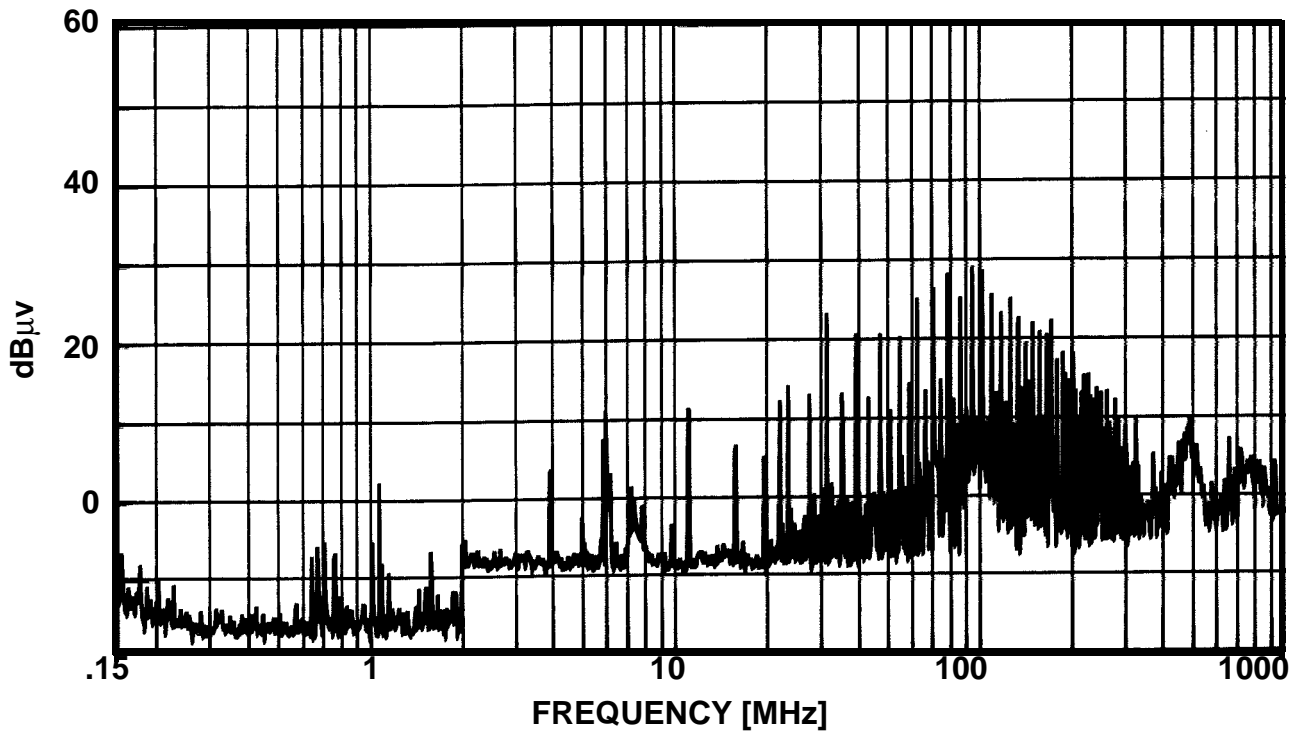

Figure 3. Emission Levels at Device Operating Frequency of 4 MHz - 28 SOIC

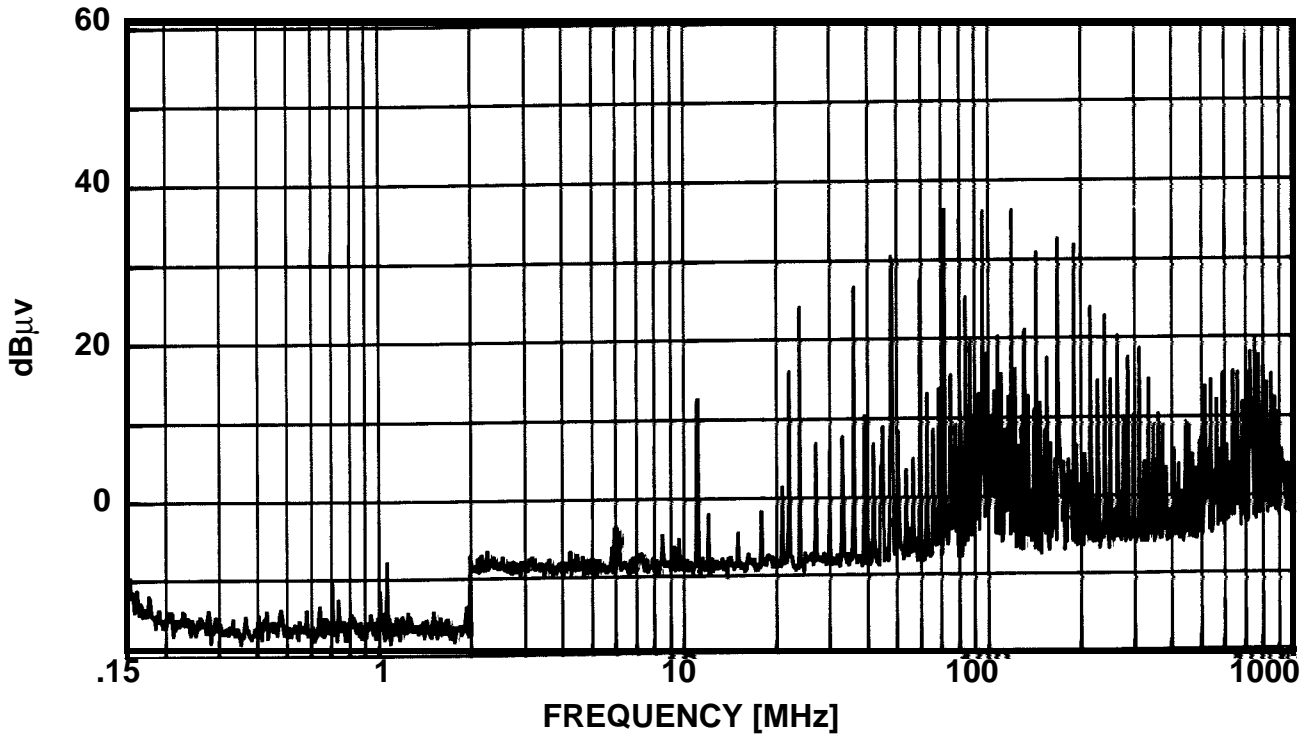

Figure 4. Emission Levels at Device Operating Frequency of 12 MHz - 28 SOIC

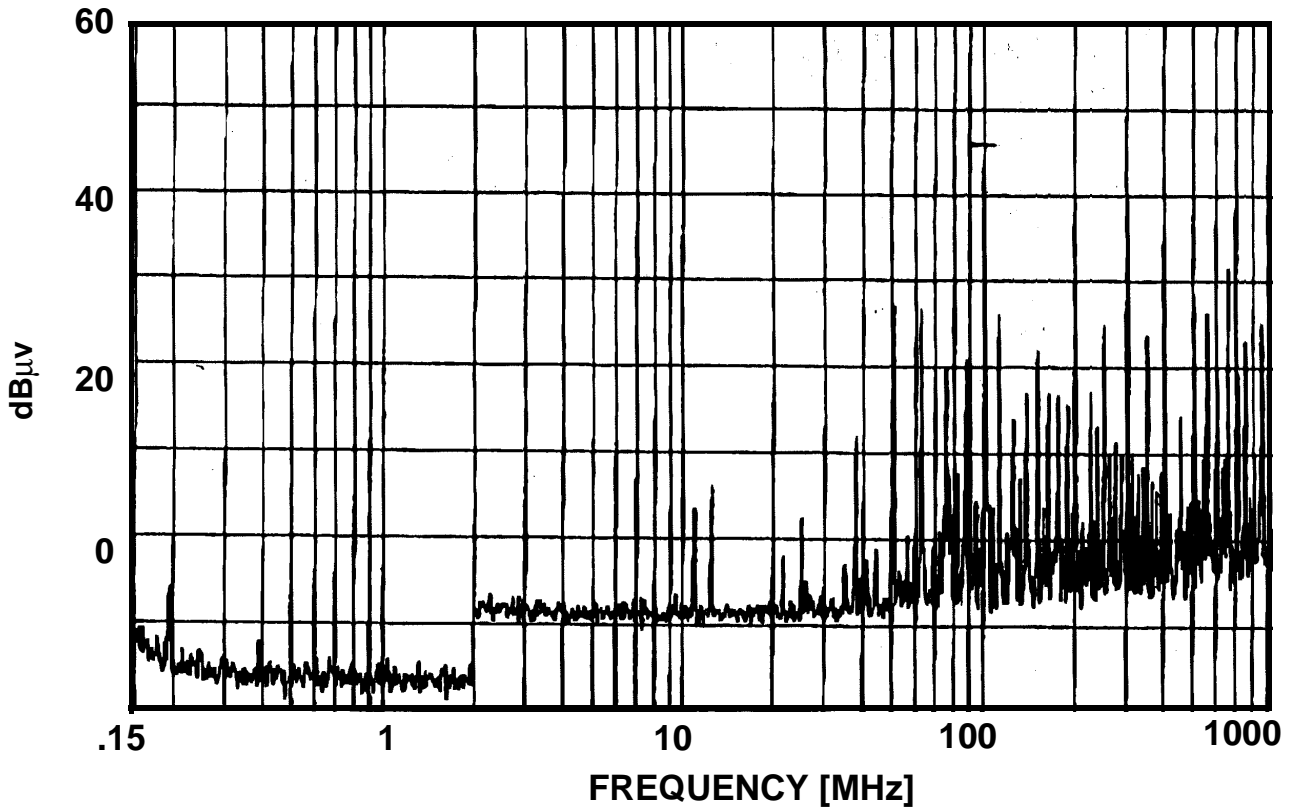

Figure 5. Emission Levels at Device Operating Frequency of 50 MHz - 28 SDIP

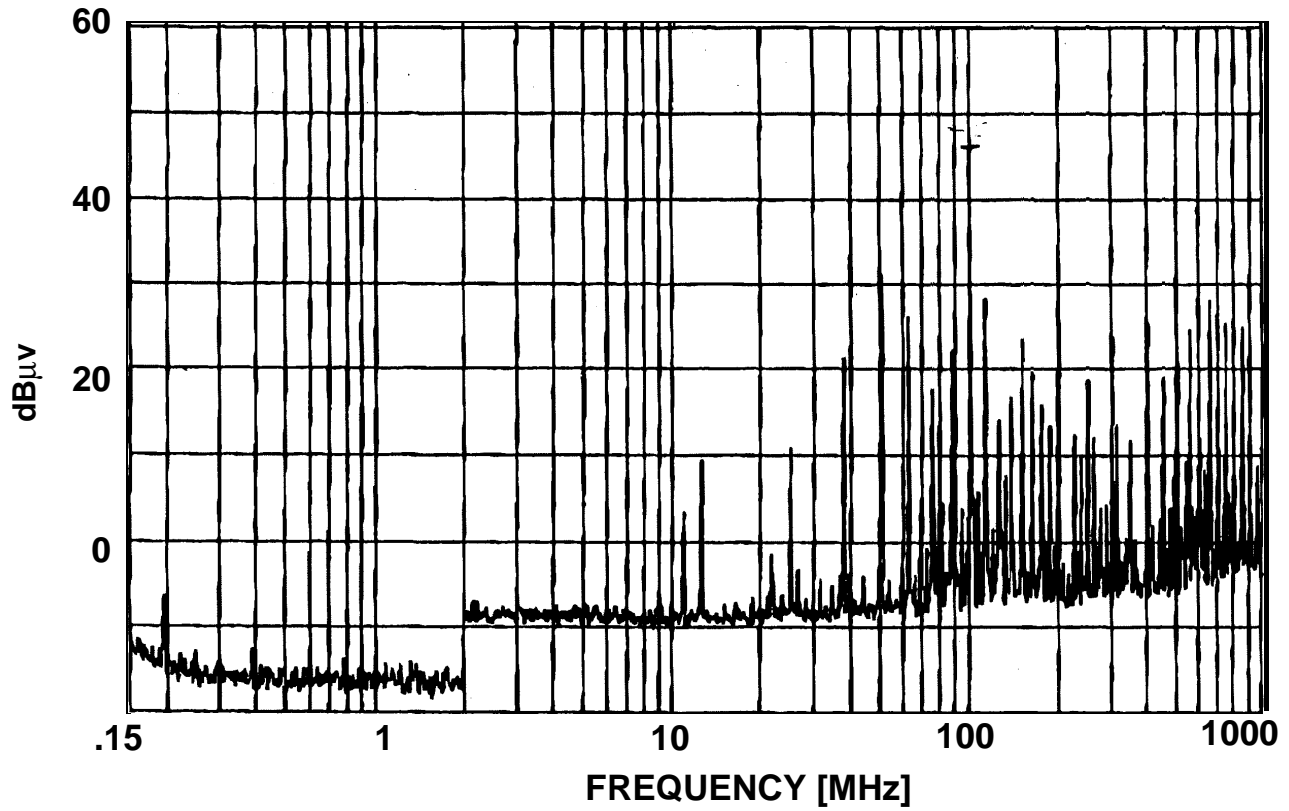

Figure 6. Emission Levels at Device Operating Frequency of 50 MHz - 28 SOIC

3.0 RADIATED SUSCEPTIBILITY

The SX device was evaluated for susceptibility based on IEC 1000-4-3 (European version EN61000-4-3) specification. The frequency range was 27 MHz to 1000 MHz.

The device did not show any susceptibility. Test setup, test equipment, and test results are attached to this report.

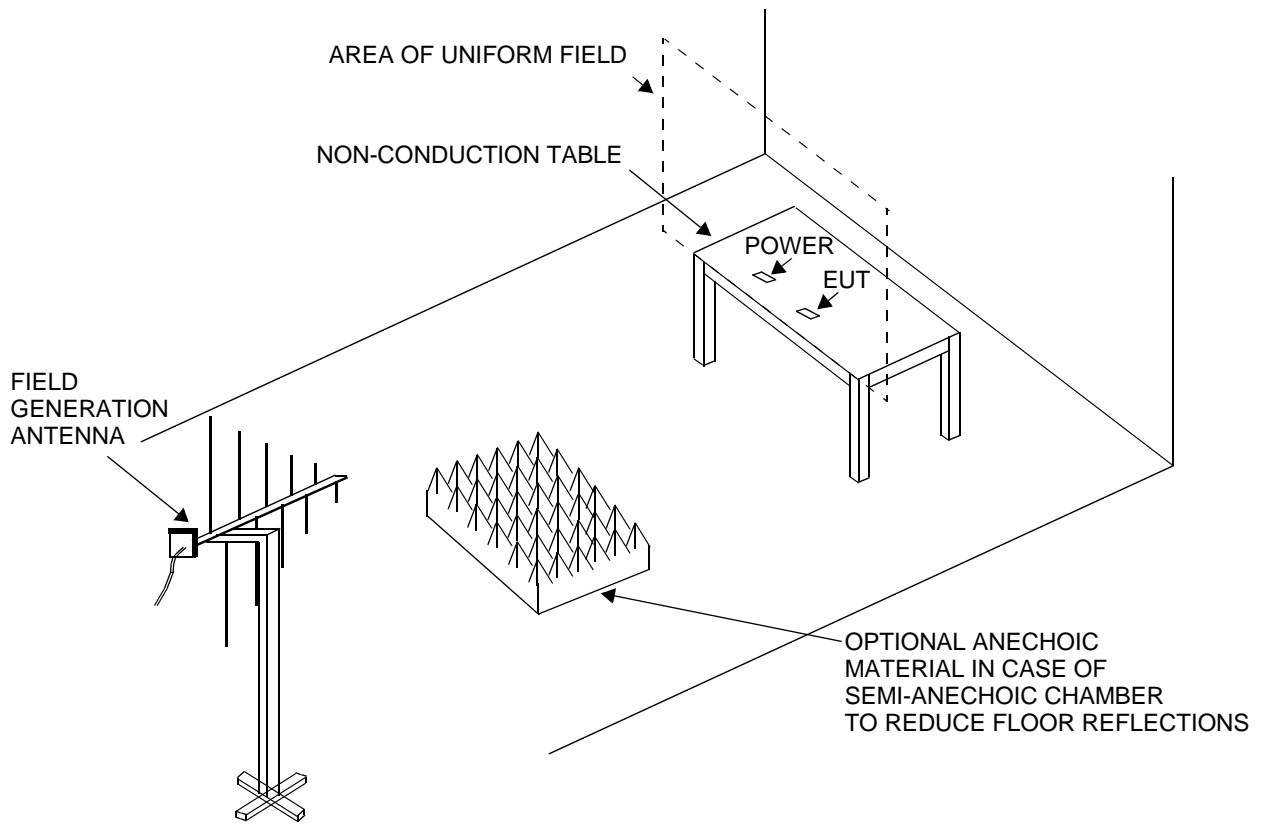

Figure 1. Radio Frequency Electromagnetic Field Test Setup

Table 1. Radio Frequency Electromagnetic Field Test Parameters

COMPANY	SCENIX	DATE	11-24-98
EUT	SX28AC COOMUNICATIONS CONTROLLER	ENGINEER	R. O. RAMIREZ At Compatible Electronics
DEVICES	SX28AC - SDIP/SOIC	AIR TEMPERATURE	20 C
SPEC	IEC 1000-4-3	BAROMETRIC PRESSURE	104.0 kPa
LEVEL	3 V/m, 1 kHz AM SINE WAVE AT 80%	RELATIVE HUMIDITY	44%
PERFORMANCE CRITERIA	A		

TEST EQUIPMENT	CAL. DATE	CAL. CYCLE
ANTENNA: Com Power Biconical, AB-900	N.C.R.	N/A
ANTENNA: Com Power Log Periodic, AL-100	N.C.R.	N/A
AMPLIFIER: Amplifier Research: 75A220	N.C.R.	N/A
AMPLIFIER: Amplifier Research: 100W1000M1	N.C.R.	N/A
SIGNAL GEN.: Giga-Tronics: 6062A	3/10/98	N/A
TEMPERATURE/HUMIDITY METER: Abbeon HTAB169B	N.C.R.	N/A
OTHER: Amplifier Research Field Monitor System, FM2000	N.C.R.	N/A
OTHER: Amplifier Research Field Probe System, FP2000	8/12/98	1 Year

Note: N.C.R. means No Calibration Required.

FREQ. RANGE (MHz)	POLARIZATION	RESULT	THRESHOLD (V/m)	COMMENTS
27 - 1000	Vertical	PASS	>3	No susceptibility observed
27 - 1000	Horizontal	PASS	>3	No susceptibility observed

and lead frame in the package).

4.0 ANALYSIS OF THE RESULTS

- The SX device passes susceptibility tests per IEC 801-3 specification despite the fact that schmitt trigger function was disabled on all I/O ports during the measurement. The schmitt trigger function, if enabled, should help reduce susceptibility further. It seems the SX I/O pins have a reasonable amount of input capacitance that allows the device to achieve high EMC tolerance.
- Near field probing indicates that modulation of the power supply lines by high frequency switching in the SX device is reduced due to placement of V_{dd} and V_{ss} pins close to each other and on one side of the package. This leads to a small trace length to the decoupling capacitor and also the smallest radiating area. The SO package is particularly advantageous in this case.
- The rise and fall times of the port drivers seem to be low enough to keep the radiated interference at reduced level due to port switching. Measurements were taken with the device being held in RESET and the results were compared with emission levels obtained during output switching. No significant difference was observed. Typically CMOS output stages may cause "shoot through" current to be drawn when switching, if the high-side and low-side drivers are both on at the same time. The SX I/O ports have slew rate control (gradual turn on) circuitry that helps control the "shoot through" effect.
- The maximum emission levels are observed at the harmonics of the operating frequency. For example, for an operating frequency of 12 MHz, the peak emission level is at 48 MHz. For 50 MHz operation, the peak level is at the 100 MHz band.
- The SDIP package seems to be noisier than the SOIC at certain frequency bands. The SOIC package provides shorter connection from the chip die to the PCB and reduces the antenna effect (short bonding wires

- The emission level increases as the operating frequency is increased. It seems the emission level is increased by 3 - 6 dBuV each time the operating frequency is doubled.

5.0 GENERAL GUIDELINES FOR PCB LAYOUT AND CONSTRUCTION

5.1 Suppression of Interference on the Supply Line

- Current and voltage peaks are the most common causes of EMI. Use of proper decoupling capacitors between Power and Ground at the power source to the board as well as on the SX V_{dd} and V_{ss} pins may help. It is also important to evaluate the proper capacitor type, frequency response, placement, output load effect, and size.
- The decoupling capacitor by itself may not be able to significantly reduce the radiated interference. Because the inductance causing the interference has already been formed, to a large extent by the packages of the ICs and the connection to the capacitor, significant improvement cannot be achieved by simply connecting in parallel several capacitors of different values. Of greater concern is preventing the current causing the disturbance from reaching the other parts of the circuit. This can be achieved by introducing an inductor behind the decoupling capacitor, which represents a sufficiently high resistance at high frequencies. The impedance of the inductor could be limited at high frequencies by a resistor of 50 Ohm connected in parallel to the inductor. A more cost effective approach is to run a small trace from V_{dd} to a capacitor, and a larger trace from the capacitor to the SX device.

5.2 Reducing the Power and Ground Loop Area

The long supply lines with the relatively large areas that these lines surround may form an effective antenna. At the frequencies present, an unacceptable level of interference may be radiated. A grounded area under the SX device must be connected to the Vss pin. In addition, the ground area should be tied to the ground plain with multiple vias. This ground area ensures that the major part of the field lines emanating from the SX are concentrated between the SX and the ground level.

5.3 Oscillator Considerations

1. The oscillator circuit needs to be analyzed with respect to the flow of significant current to determine where the interference suppression is necessary.
2. Since the SX power and ground pins are on the opposite side of the package from the one for the oscillator pins, one needs to evaluate the effect of the larger loop created as a result of connecting the oscillator capacitors to the ground. This large loop will result in larger amount of current flow in the oscillator resonant circuit. The creation of a ground plane underneath the chip (mentioned above to reduce the power line loop) will help shorten the loop effect. In addition, it will be useful to run the capacitor ground connection close and in parallel to the clock input and output signals. If ground area underneath the chip is not available, the capacitor should be directly connected to the SX ground pin through a short and independent trace. Figure shows the recommended oscillator circuit layout.
3. The shape of the oscillator signal should be observed with a low capacitance FET probe to identify any ringing. The oscillator signal should look smooth. Impedance matching techniques can be employed to smoothen the oscillator signal.

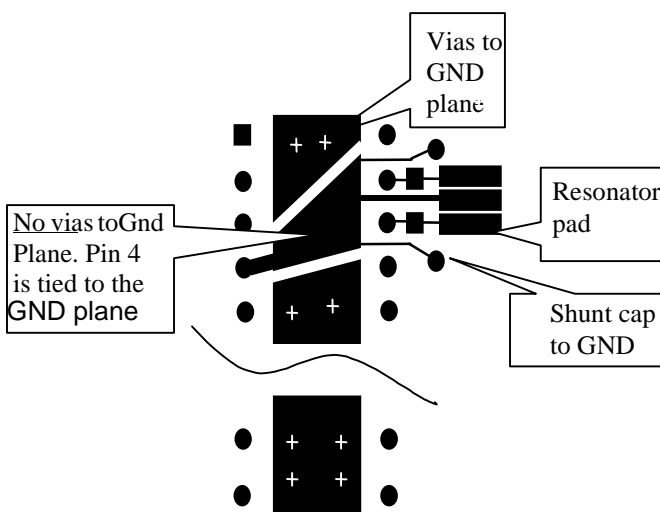

Figure 1. Oscillator Circuit Layout

5.4 Handling High Speed I/O Signals

1. High speed signals should be close to the ground plane or ground signals. High speed signal wires and their returns should be as short as possible and put in the smallest possible area. As mentioned in Section 4.0, the SX output drivers have slew rate control (gradual turn on), it may still be beneficial to slow I/O pin transition further by adding 10 pF capacitors on the I/O pins. This is useful in applications that involve large amount of data transfer into/out of the SX device.
2. High speed signals should be shielded and kept away from other signals, in order to avoid crosstalk, particularly on high resistance and level sensitive tracks. The tracks should be routed sufficiently far apart or run parallel to a track connected to the system reference voltage, usually ground, to provide shielding.

5.5 General Considerations

1. If the PCB contains both analog and digital circuits, there should be separate analog and digital power supplies and grounds.
2. Single point connection of tracks for analog ground and power supply. In order to avoid different potentials a galvanic connection at only one point is desirable. Track loops should be avoided (also less susceptible to interference).
3. Large ground plane. If the size of the ground plane is increased, the radiating area due to current loops will be reduced. Additionally, the capacitance to ground of the digital lines is increased which could lead to an increase in the interference caused by switching currents.
4. Low inductance connections. The use of short connecting wires results in a reduction of any inductive voltage spikes as $V_i = L \cdot di/dt$ at constant di/dt when switching.
5. If the board physical layout permits, it is beneficial to keep the power connector (power source to the board) and other connectors (such RS-232) on the same side of the board.
6. On a two-sided board, if the back side is copper poured, try to keep this side free of components, traces, and "cuts" as much as possible to leave more ground metal area.
7. Using a multi-layer board can lead to reduction in emitted interference. The improvement is due to the reduction in track length and the reduction of Vdd to ground impedance, for example if Vdd/ground grid is used.

Lit.#: AN03-03

Sales and Tech Support Contact Information

For the latest contact and support information on SX devices, please visit the Ubicom website at www.ubicom.com. The site contains technical literature, local sales contacts, tech support and many other features.



**1330 Charleston Road,
Mountain View, CA 94043**
Contact: Sales@ubicom.com
<http://www.ubicom.com>
Tel.: (650) 210-1500
Fax: (650) 210-8715