

If oscillator is required instead of crystal cut ground trace and solder a bridge to next +3.3V via

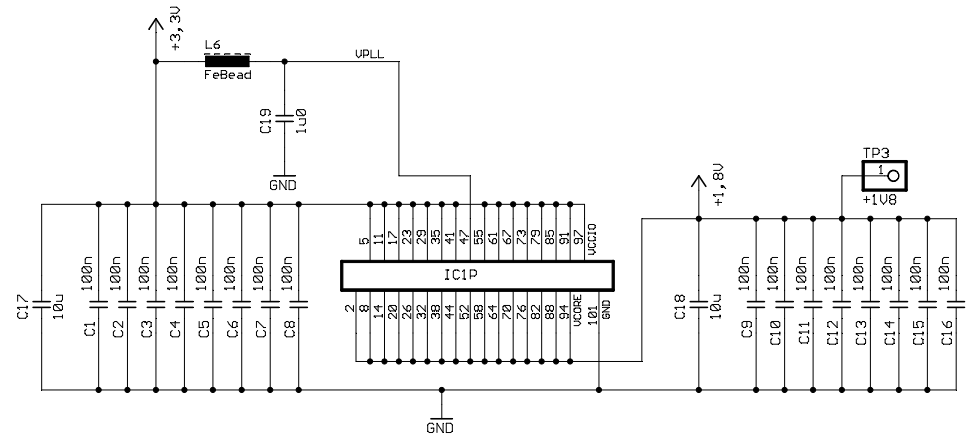

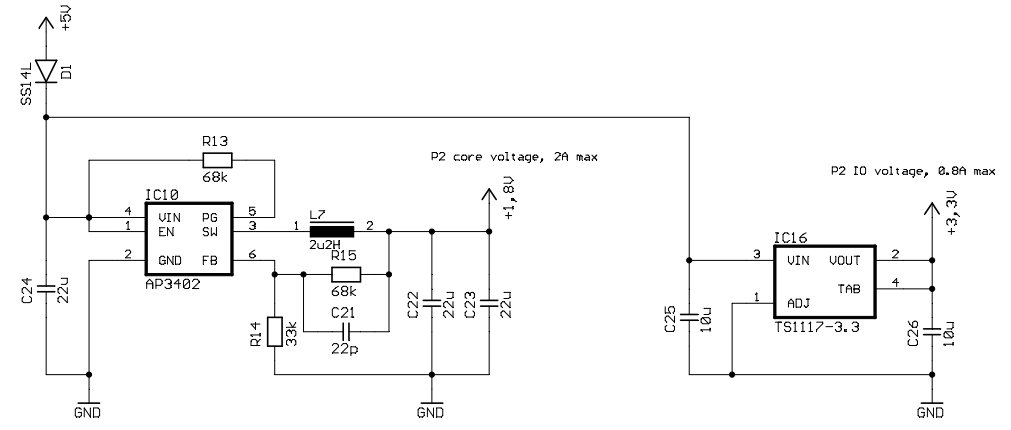
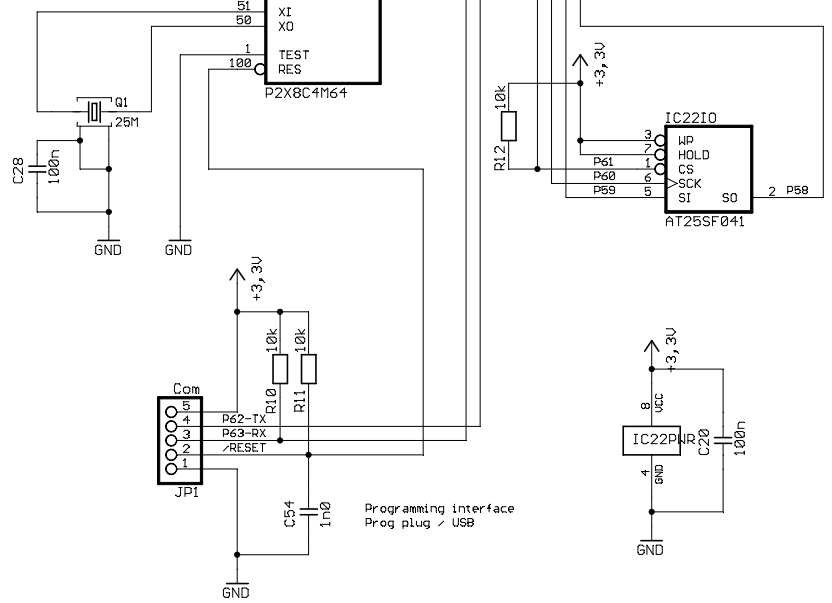
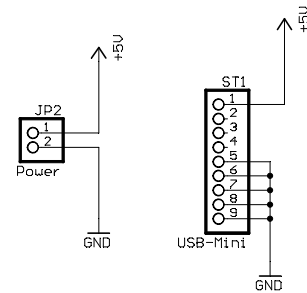
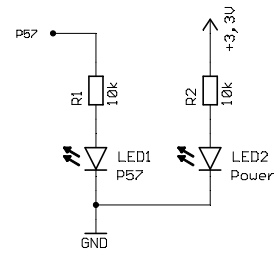
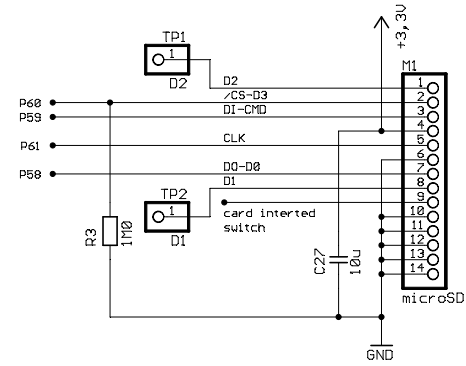
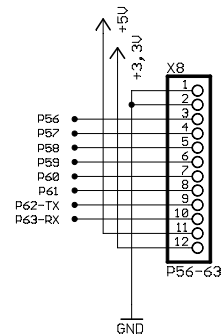
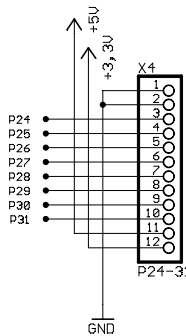
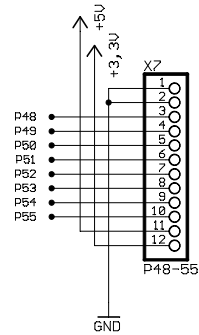
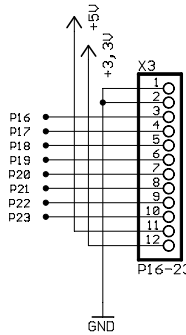
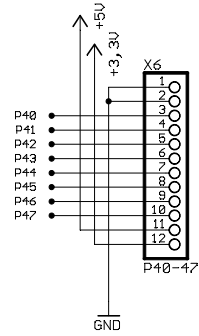
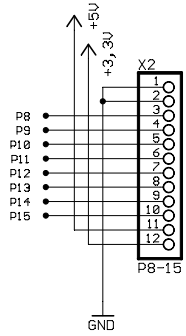
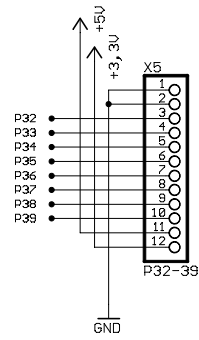
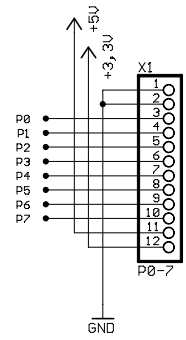

Kiss2 Propeller2 Low cost Evaluation board	
TITLE: P2-Kiss2	
Document Number:	REV:
Date: 21.07.2021 16:32:00	Sheet: 2/2