

GP2Y0E02A,GP2Y0E02B,GP2Y0E03 Application Note

Table of Contents	Page
1. Introduction	2
2. Outline and terminals	2
3. Electro-Optical Characteristic	3
4. Timing Chart	3
4-1 Power on/off timing	3
4-2 Active/Stand-by timing sequence	3
5. Principle of Optical Distance Measurement Sensor	6
6. Notes on Using	6
6-1 Emitting Lens and Receiving Lens	6
6-2 Mirror Reflector	6
6-3 Object near the Optical Path	7
6-4 Reflective Object with Boundary Line	7
6-5 Reflective Object Size	7
6-6 Tilt of Reflective Object	9
6-7 Protection Cover	9
6-8 Multiple Operation and Optical Interference with Other Devices	10
7. Response Time	11
8. Ambient Temperature Characteristic	11
9. Ambient Light Characteristic	12
10. I ² C interface	12
10-1 I ² C data transfer format	13
10-2 Write Format	13
10-3 Read Format	13
10-4 I ² C Bus Timing	14
10-5 I ² C DC Timing Characteristic	15
10-6 Register Map	15
11. Functions which is possible to be set	18
11-1 Slave Address	18
11-2 Maximum Pulse Width of Emitting	19
11-3 Signal Accumulation	19
11-4 Median Filter	19
11-5 Cover Compensation	20
11-6 Error Judgment of Distance Measurement	23
11-7 Maximum Output Distance	26
11-8 Active/Stand-by State Control	26
11-9 Software Reset	26
12. E-Fuse Programming	27
12-1 Set-up for Programming	27
12-2 Electrical Specification	28
12-3 Programming Flow	29
12-4 E-Fuse Bit Map	29
12-5 E-Fuse Bit Replacement	37
12-6 Example of E-Fuse Programming	37

1. Introduction

The GP2Y0E series are active optical distance measurement sensors. These sensors measure the distance to an object by detecting the light spot position of reflection on the detector. It is possible to measure the distance with high accuracy by adoption of CMOS image sensor. It is not necessary for the customer to calibrate the distance output. The three models have differing output types and operating voltages. The differences are shown in table.01.

Table.01 The list of GP2Y0E series

	Distance output	Terminals	VDD	Detection range
GP2Y0E02A	Analog	4	2.7~3.3V	4~50cm
GP2Y0E02B	Digital (I ² C bus)	4	2.7~3.3V	4~50cm
GP2Y0E03	Analog Digital (I ² C bus)	7	2.7~5.5V (*)	4~50cm

(*)
In case of applying it below 3.3V, VDD and VIN(IO) could be used same power supply line.
In case of using it over 3.6V (for example, VDD=5.0V), it is necessary to apply the voltage over 3.3V to the VIN(IO) terminal.

2. Outline and terminals

The GP2Y0E series line-up is GP2Y0E02A , GP2Y0E02B and GP2Y0E03. Fig.01 shows the outline comparison between the three models. GP2Y0E03 has both analog output and digital output through I²C bus. Table.02 shows the list of outline and terminal information.

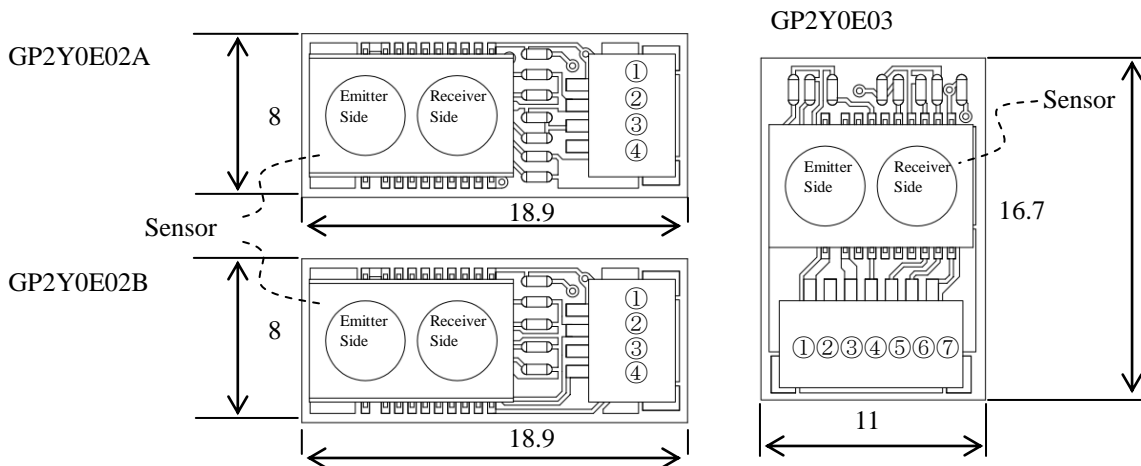

Fig.01 Outline of GP2Y0E series

Table.02 Outline and terminals

	L [mm]	W [mm]	H [mm]	Terminals						
				①	②	③	④	⑤	⑥	⑦
GP2Y0E02A	18.9	8.0	5.2	VDD	GND	Vout(A)	GPIO1	-	-	-
GP2Y0E02B	18.9	8.0	5.2	VDD	GND	SDA	SCL	-	-	-
GP2Y0E03	11.0	16.7	5.2	VDD	Vout(A)	GND	VIN(IO)	GPIO1	SCL	SDA

• Symbol of terminals

- VDD: Power supply
- GND: Ground
- Vout(A): Analog output voltage
- GPIO1: Active / stand-by condition switching terminal
- SDA: I²C data bus
- SCL: I²C clock
- VIN(IO): I/O supplying voltage

Input/output voltage of I²C communication and input voltage of GPIO1 terminal is determined by the input voltage of VIN(IO) terminal.

The same sensor is used in the GP2Y0E series. The connector and board on which the sensor is mounted is different for each model. GP2Y0E03 has independent input terminals for VDD, GPIO1 and VIN(IO). VIN(IO) terminal is connected to VDD terminal in the GP2Y0E02A board. VIN(IO) and GPIO1 terminal is connected to VDD terminal in the GP2Y0E02B board.

3. Electro-optical Characteristics

Electro-optical characteristics of three models are same because same sensor portion is used in GP2Y0E series, though each board is different.

Table.03 Electro-optical characteristic

(Ta=25°C, VDD=3.0V)

Parameter	Symbol	Condition	GP2Y0E02A			GP2Y0E02B			GP2Y0E03			Unit
			Min.	Typ.	Max.	Min.	Typ.	Max.	Min.	Typ.	Max.	
Measuring distance range	L		4	-	50	4	-	50	4	-	50	cm
Distance value	D1	L=50cm	/			45	50	55	45	50	55	cm
	D2	L=10cm				9	10	11	9	10	11	cm
	D3	L=4cm				3	4	5	3	4	5	cm
Output terminal voltage	Vout(A)1	L=50cm	0.3	0.55	0.8	/			0.3	0.55	0.8	V
	Vout(A)2	L=10cm	1.9	2	2.1				1.9	2	2.1	V
	Vout(A)3	L=4cm	2.1	2.2	2.3				2.1	2.2	2.3	V
Average supply current	Icc1		-	26	36	-	26	36	-	26	36	mA
Stand-by supply current	Icc2		-	20	60	-	20	60	-	20	60	uA
Response time	Ts		-	-	40	-	-	40	-	-	40	ms

4. Timing Chart

4-1 Power On/Off timing sequence

(GP2Y0E02A)

The specification for power on/off timing is not fixed .Because VDD is connected to VIN(IO) internal board.

GPIO1 should be set after or at the same time VDD has turned on. (refer to Fig.3a)

In case that VDD is off, GPIO1 should be pull Low. (not shown in Fig.)

(GP2Y0E02B)

The specification for power on/off timing is not fixed .Because VDD is connected to VIN(IO) internal board.

I²C communication with other devices connected to the same bus is not allowed after VDD is turned off.

(refer to Fig.3b)

In case that VDD is off SCL and SDA should be pull Low. (not shown in Fig.)

(GP2Y0E03)



T1,T2,T3,T4 : Refer to Table.04

Fig.02 Power on/off timing sequence

VIN(IO) should be turned off before VDD is turned off, or at the same time when VDD is turned off. (refer to Fig.3)

I²C communication with other devices connected to the same bus is not allowed after VDD or VIN(IO) is turned off. In

case that both of VDD and VIN(IO) is turned off, GPIO1, SCL and SDA should be pull low. In case that only VIN(IO)

is turned off, GPIO1, SCL and SDA should be pull low.

If this product is operated under the condition other than the above, this product or other device around it may suffer damage due to excessive current.

4-2 Active/Stand-by timing sequence

Active or Stand-by states of GP2Y0E02A can be changed by the input voltage (Hardware) in GPIO1 terminal.

The states of GP2Y0E02B can be changed by the register setting (Software) through I²C bus. The states of GP2Y0E03

can be changed by Hardware and Software. Timing charts of each model are shown in Fig.03. I²C bus timing chart of

GP2Y0E02A is shown in Fig.03a because this communication is used by I²C from the contact pad on the back of board only in case that some data is written in E-Fuse (refer to 12. E-Fuse Programming, Fig.38)

Hardware : GPIO1 is set High or Low.

GPIO1 = 「High」 : Active state

GPIO1 = 「Low」 : Stand-by state

Software : I²C register program (refer to 11-8 active/stand-by state control)

Software control is effective when GPIO1 is high.

4-2-1 GP2Y0E02A

(1) Controlled by GPIO1

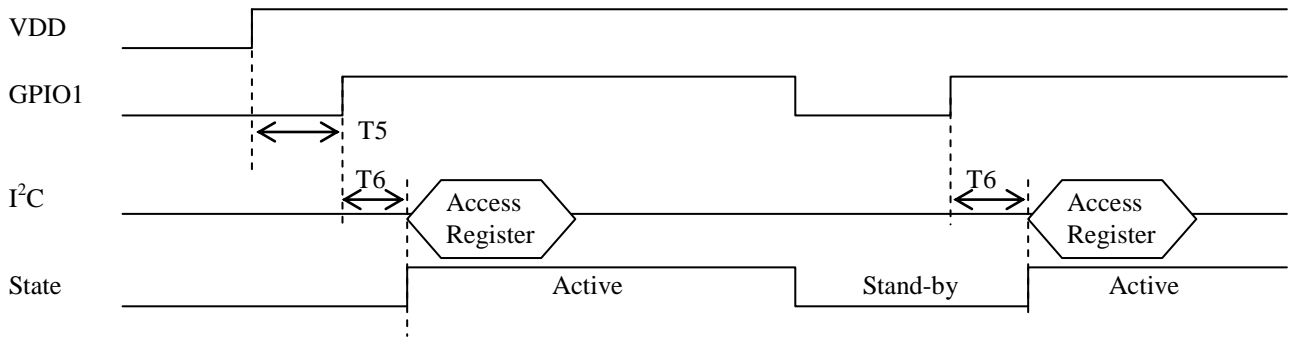

(2) Controlled by register setting through I²C bus

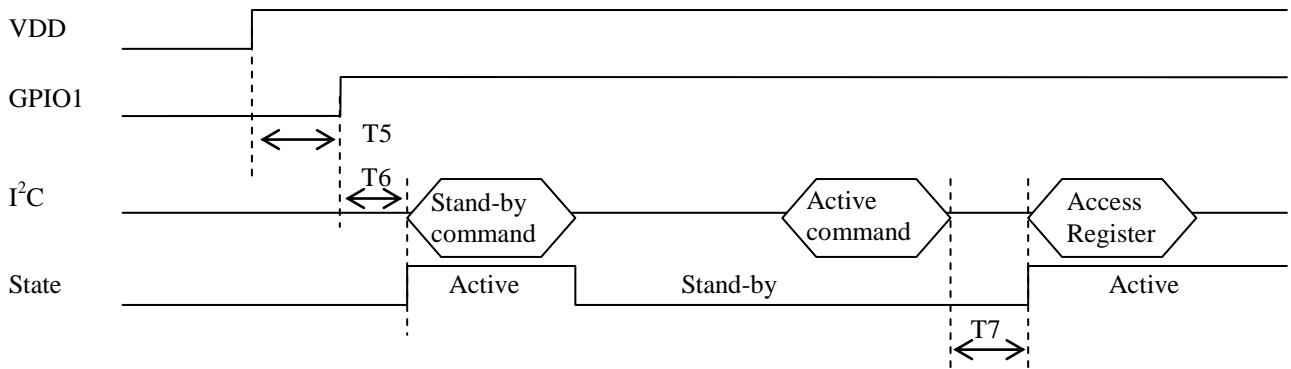

Fig.03(a) Timing chart of active/stand-by state control (GP2Y0E02A)

4-2-2 GP2Y0E02B

(1) Controlled by register setting through I²C bus

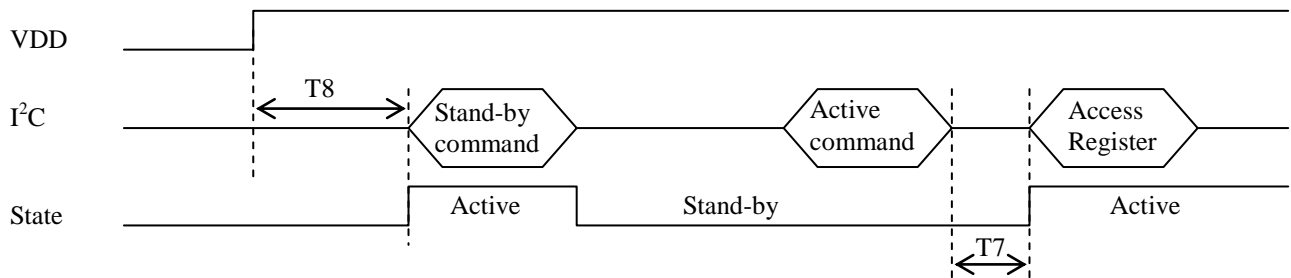
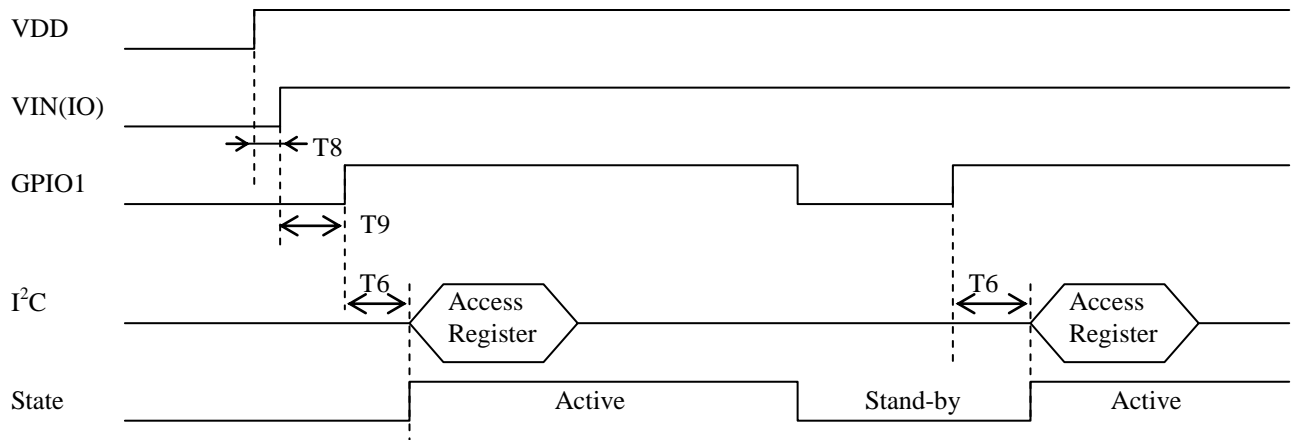

Fig.03(a) Timing chart of active/stand-by state control (GP2Y0E02B)

4-2-3 GP2Y0E03

(1) Controlled by GPIO1



(2) Controlled by register setting through I²C bus

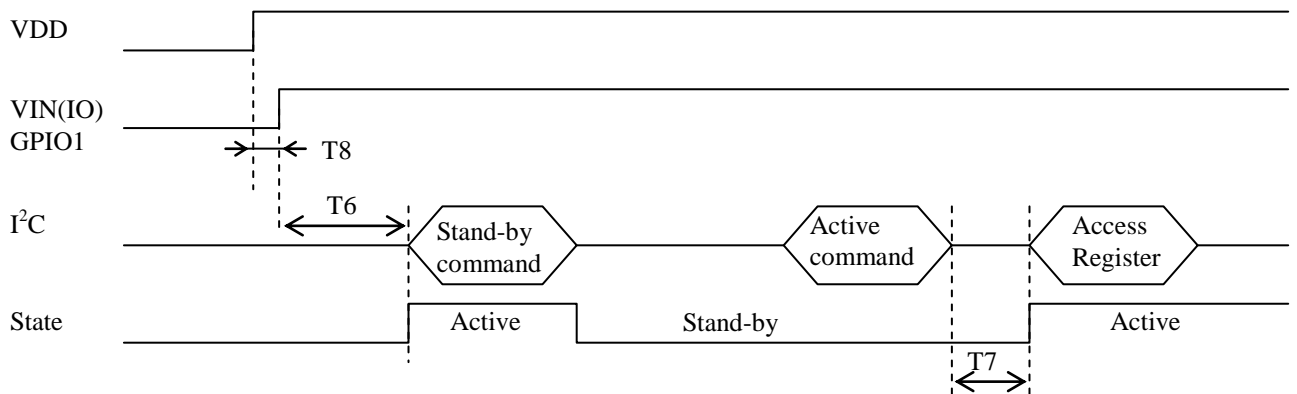

Fig.03 Timing chart of active/stand-by state control (GP2Y0E03)

Table.04 Specification of timing

	Description	Min	Max	Unit
T1	IO power delay after VDD power on	0	5	ms
T2	VIN(IO) leading to VDD power off	0	-	us
T3	Vpp power delay after VIN(IO) power on	0	-	us
T4	Vpp leading to VIN(IO) power off	0	-	us
T5	GPIO1 delay after VDD power on	0	-	us
T6	I²C access delay after GPIO1 high	500	-	us
T7	I²C access delay after active command completed	500	-	us
T8	I²C access delay after VDD power on	500	-	us
T9	GPIO1 delay after VIN(IO) power on	0	-	us

5. Principle of optical distance measurement sensor

GP2Y0E series is the active type distance measurement sensor which is based on triangulation. Light spot position of reflection which is condensed on the optical detector (CMOS image sensor) is measured. Since the spot position changes with the distance to a reflective object as shown in Fig.04, the distance to a reflective object can be calculated by using measured spot position.

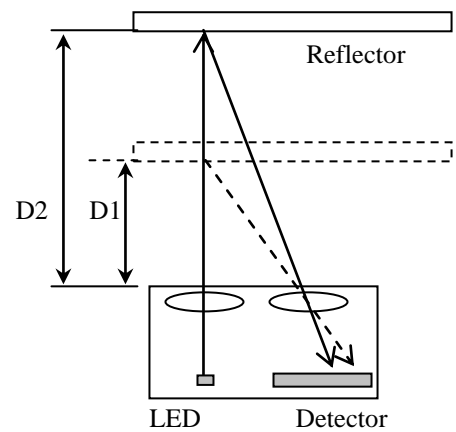

Fig.04 triangulation

6. Notes on using

Since the distance is measured by using the principle of the above, however, in actual use, please note the following points.

6-1 Emitting Lens and Receiving Lens

The lens of this device should be kept clean. There are cases that dust, water or oil can deteriorate the characteristics of this device. Please consider in actual application.

Please don't wash this sensor because the optical characteristics may be changed. When using this sensor, please make sure that it is possible to carry out in accordance with the measurement environment because this sensor does not have chemical resistance.

6-2 Mirror Reflector

The distance between sensor and mirror reflector cannot be measured exactly. Fig.05(a) shows that mirror reflector is placed to be parallel to the sensor at the distance of D1. Emitting beam with the directional angle shown in Fig.10 is irradiated at the surface of mirror. Right edge of the ray is detected by detector as shown in Fig.05(a) because the ray is specular reflection on the mirror. Reflected ray (dashed line) by the scattering reflector at the distance of D2 has same path as the specular reflection of right edge ray by the mirror at the distance of D1. Therefore, D2 is measured under this condition. On the other hand, Fig.05(b) shows the mirror reflector is placed to have tilt angle of θ at the distance of D1. Left edge of the ray is detected by detector as shown in Fig.05(b). Reflected ray by the scattering reflector at the distance of D3 has same path with the specular reflection of left edge ray by the mirror at the distance of D1. Therefore, D3 is measured under this condition.

In this way, specular reflection of mirror object has large influence to the light spot position. The light spot position is changed by the tilt angle between the mirror object and the sensor even if the mirror object is placed at the same distance.

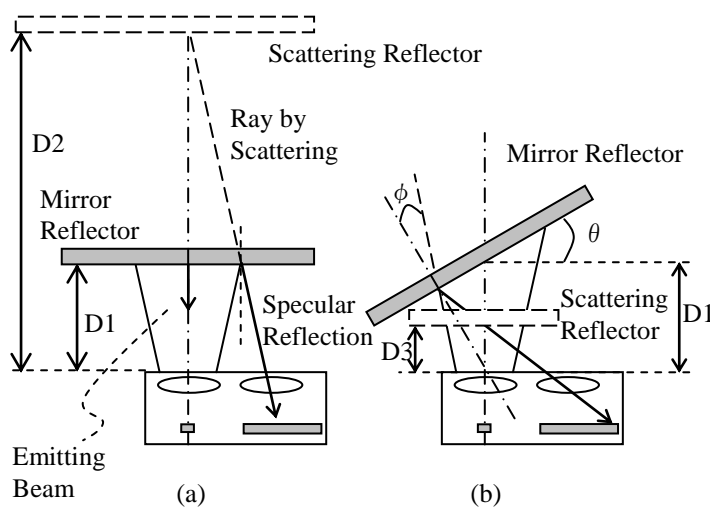

Fig.05 Mirror Reflector

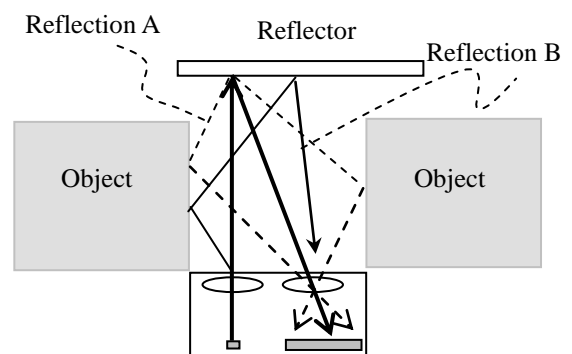

Fig.06 Case that object is near the sensor

6-3 Object near the Optical Path

In case that an object is near the optical path, the light spot position may change because a part of reflection by the reflector may incident in the light receiving portion after reflection by the object near the sensor as shown in reflection A (dashed line) of Fig.06. In addition, the light spot position may be changed because a part of emitting beam is scattered by the object near the sensor as shown in reflection B (solid line) of Fig.06. For this reason, it may not satisfy the specification of the electro-optical characteristic.

GP2Y0E series have the error judgment function that distance output is fixed to maximum value in order to avoid distance measurement error in case that receiving light spot profile is affected by the object near the sensor. There is case that distance output is fixed to maximum in case that reflection intensity from A and B is large enough compared with that from the reflector. Please refer to 11-6 Error Judgment of Distance Measurement for the details.

Please use it after confirming that the distance output does not changed by this object with customer's product.

6-4 Reflective Object with Boundary Line

In case that reflective object has a boundary line, there is case that distance can not be measured exactly. Emitting beam is reflected by the high reflectance portion and low reflection portion when the reflective object boundary line and the center of optical axis is in agreement. Fig.07 shows an example case that left side of reflector has high reflectance and right side has low reflectance. The intensity of reflection A is larger than that of reflection B as shown in Fig.07. Measuring distance may have an error because light spot position is shifted toward reflection A compared with reflection with uniform reflectance. At that time, if direction of boundary line and the line between emitter center and detector center are parallel, it is possible to decrease deviation of measuring distance.

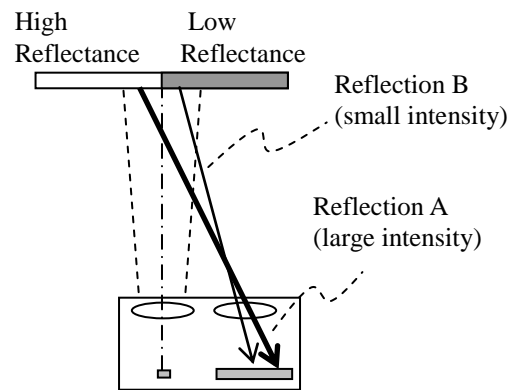
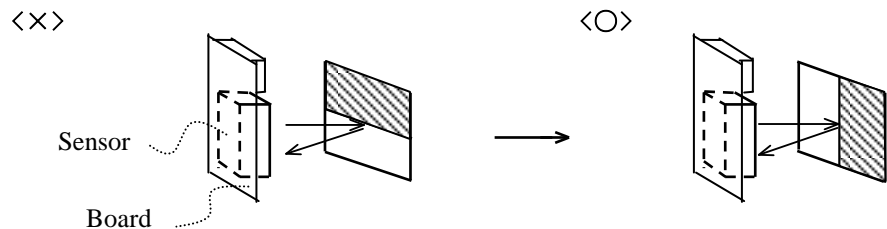

Fig.07 Reflective object with boundary line

GP2Y0E02A/GP2Y0E02B



GP2Y0E03

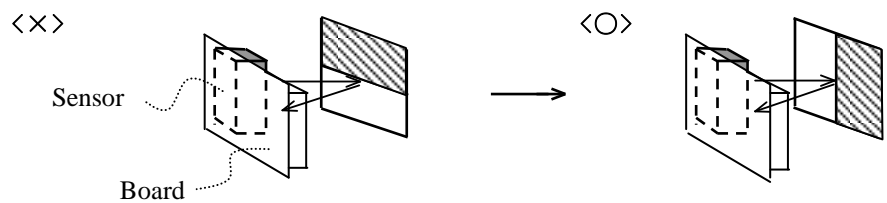

Fig.08 Recommended measurement of reflective object with boundary line

GP2Y0E series have the error judgment function that distance output is fixed in order to avoid distance measurement error. Please refer to 11-6 Error Judgment of Distance Measurement for the details.

6-5 Reflective Object Size

For satisfying the specification of the electro optical characteristic, it is necessary to install a flat object vertically to the emitted light, and it is necessary to reflect the whole emitted light as shown in Fig.09. As shown in the example of directional angle of emitting beam of Fig.10, the angle is around $6^\circ (\pm 3^\circ)$ where emission becomes 10% of peak. The object needs to exist in around 10 degrees (± 5 degrees) area including the variation of peak position. For example, when the object is in 50 cm, it is necessary to install the object of at least 9cm diameter parallel to the surface of this sensor as follows. However above example doesn't guarantee specification, please use it after confirming with customer's product.

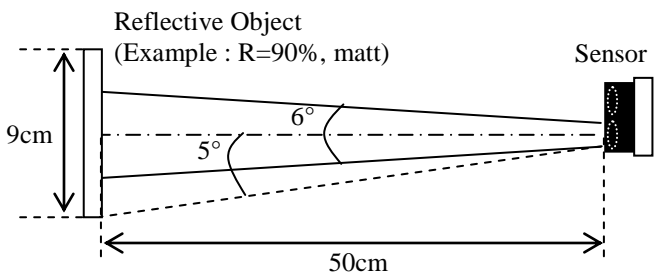

Fig.09 Reflective Object Size

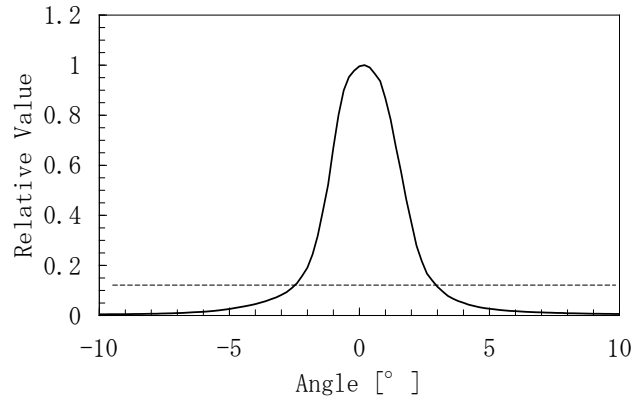

Fig.10 Example of Directional Angle of Emitting Beam

In case that a part of the reflective object is irradiated by emitting beam, there is case that distance can not be measured exactly for the same reason of section 6-4 Reflective Object with Boundary Line. In case that whole emitting beam is reflected by reflective object (not shown in Fig.11), light spot is incidented at the position of reflection A (dashed line) in Fig.11. However, in case that reflective object is shifted toward emitter side as shown in Fig.11, light spot is incidented at the position of reflection B (solid line) because a part of emission beam is reflected. Under this condition, light spot is formed at the position where is shifted toward right side compared with reflection A. So, measured distance becomes smaller than distance to reflective object as shown in Fig.11.

For above reason, in order to decrease measuring error due to moving direction of reflective object, we recommend to mount the sensor as shown in Fig.12.

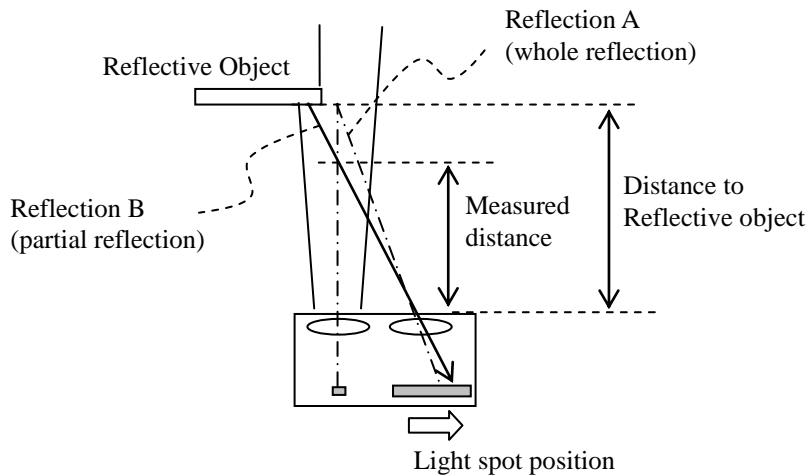
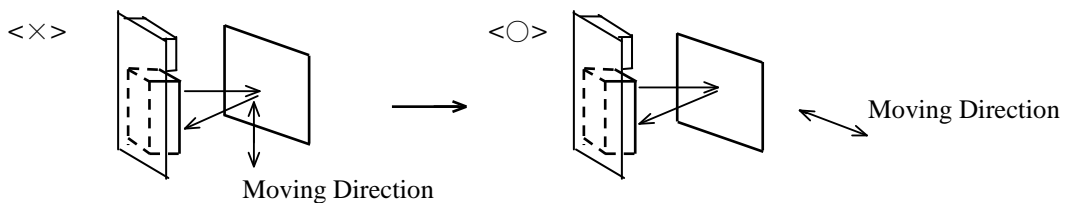

Fig.11 Partial Reflection of Emitting Beam

GP2YE02A/GP2Y0E02B



GP2Y0E03

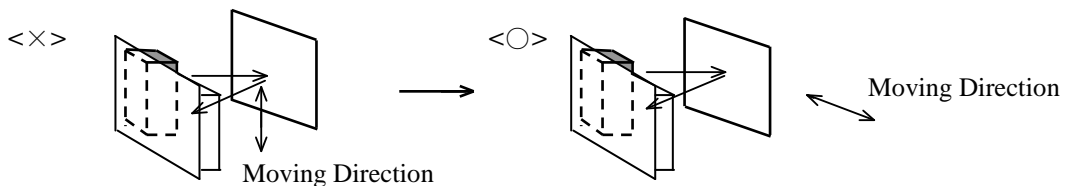

Fig.12 Moving Reflective Object

GP2Y0E series have the error judgment function that distance output is fixed to be maximum (64cm) to avoid distance measurement error. Please refer to 11-6 Error Judgment of Distance Measurement for the details.

6-6 Tilt of Reflective Object

For satisfying the specification of the electro optical characteristic, it is necessary to install a flat object vertically to the emitted light, and it is necessary to reflect the whole emitted light as shown in Fig.09. There is the case that it is not possible to measure distance exactly in case that reflective object is installed with tilt angle to the sensor. Fig.13 is shown in the example case that reflective object is installed with the tilt angle to the sensor. Fig.13(a) is shown that reflective object is installed with the tilt angle of θ to the axis which the light emitting and receiving lens are arranged. Fig.13(b) is shown in the example case that reflective object is installed with the tilt angle of ϕ in the direction perpendicular to Fig.13(a). Fig.14 is shown in the example of tilt angle dependence in case that reflective object (R=90%, matt) is installed at the distance of 50cm from the sensor. The distance output changes in dependence of the tilt angle for θ direction. But the tilt angle dependence of distance output for ϕ direction is small. This characteristic is reference data measured by the arbitrarily extracted sample and not guaranteed. Please use it after confirming with customer's product.

In case that tilt angle for θ is large, there is the case that the light spot size is changed largely compared with recommendation condition of Fig.09. GP2Y0E series have the error judgment function that distance output is fixed to be maximum to avoid distance measurement error. Please refer to 11-6 Error Judgment of Distance Measurement for the details.

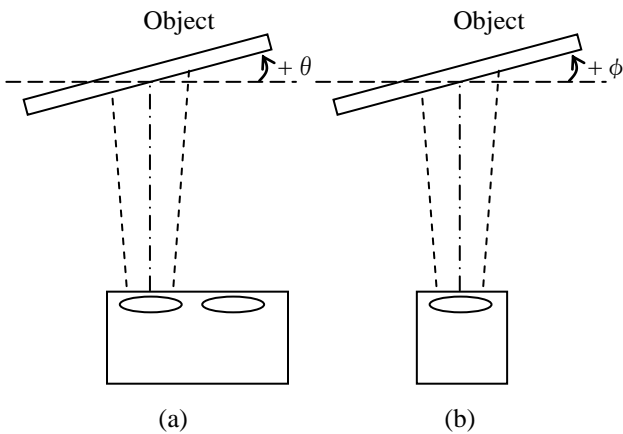

Fig.13 Reflective Object with Tilt Angle

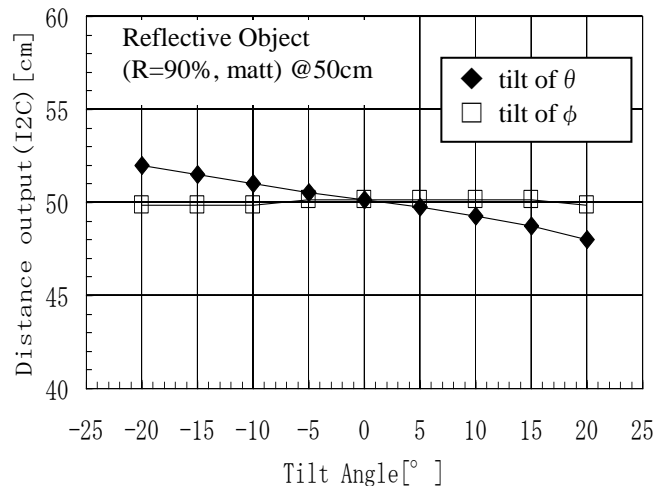

Fig.14 Tilt Angle Dependence of distance output

6-7 Protection Cover

In case that protection cover is set in front of this sensor, the protection cover shall be recommended to use material which doesn't scatter light and be matted finish. And the protection cover which has the most efficient transmittance at the emitting wavelength range of LED for this product ($\lambda=850\text{nm}\pm 70\text{nm}$). This protection cover is recommended to be flat. This protection cover shall be recommended to be parallel to the emitter and detector portion. In case that protection cover is set in front of this sensor, it emits reflected light from this protection cover. If this reflective light reaches in detector portion, the output distance of this product may be changed. The output distance characteristics of this product may be changed with according to material (①) or transmittance (②) or the thickness (③) or the distance between the protection cover and this product (④) or the angle between surface and back (⑤) or the angle between this cover and this sensor (⑥). In case that protection cover is set, please design to consider that this reflective light is minimized. It shall be effective to put light shield wall between emitting lens and receiving lens as shown in Fig.16. Reference conditions in case of using protection cover are shown in Table.05. Where, below are fixed condition that ①material=acrylic, ②transmittance>90% @850nm, ⑤angle between surface and back of cover=parallel, ⑥angle between sensor and cover=parallel. In addition of above, surface and back face of cover has mirror polished surface.

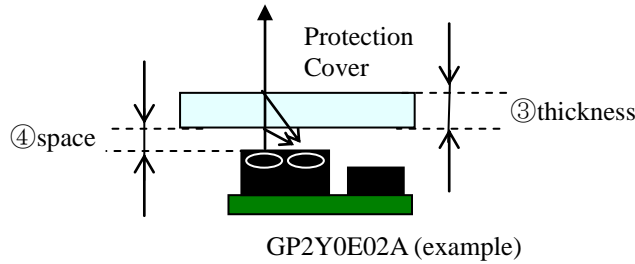

Fig.15 Protection Cover Installation

Table.05 Install condition of protection cover

Condition	③thickness	④space	Light shield wall
No1	1mm	0mm	—
No2	1mm	1mm	without
No3	2mm	0mm	—
No4	2mm	1mm	with

Direct reflective light increases as Distance from sensor to protection cover and thickness of this cover increases. In case thickness is 2mm and distance is 1mm, measuring distance is changed shift larger from actual distance than other condition. Shifts can be made small by using installation of light shield and cover compensation function (refer to 11-5 Cover Compensation). However, there are the cases that distance error does not decrease even if cover compensation function is used in a sensor, depending on the conditions of protection cover.

• Noted for installation of light shield

Inner distance between lens of detector and lens of emitter is around 0.6mm (reference). So the width of light shield is recommended to be less than 0.6mm. In case the width of light shield is longer than inner distance, measuring distance is changed by shielding a part of emitter lens or detector lens. Please confirm that there is no problem under the actual equipment. And in case between protection cover and light shield or between light shield and this sensor exists space, the effect of light shield is small because light from emitter leaks. The light shield wall is recommended to use the material that have the low transmittance at the emitting wavelength range of LED for this product ($\lambda=850\text{nm}\pm 70\text{nm}$). When the material of light shield wall is hard, and the power stress in which it is added to this product is large, measuring distance may shift from actual distance.

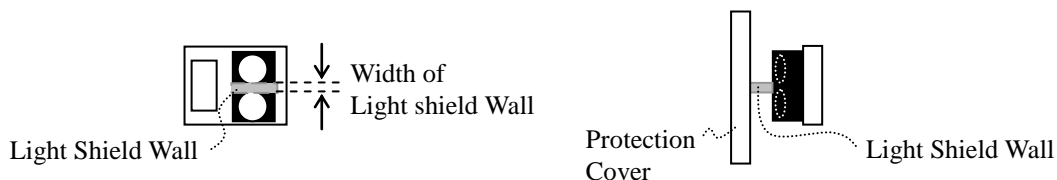

Fig.16 Example of light shield installation

Neither installation of a light shield wall nor use of a compensation function guarantees the distance characteristic. These improve error shift of the distance characteristic. Regardless of usage of a light shield wall or a compensation function, please use it after confirming with customer's product.

6-8 Multiple Operation and Optical Interference with Other Devices

In case that some devices which emits modulated infrared light are operated at the same time, there is a possibility that this sensor would malfunction by incidence of emitted light by other devices. There is also a possibility that other devices would malfunction by incidence of emitted light by this sensor. Please consider the design of the finish product that the detector of this device does not receive the light emitted from the other devices. Or, please turn this sensor to the stand-by state when other devices operate, so that emitted light by other devices do not detect. GP2Y0E02A and GP2Y0E03 has GPIO1 terminal which role is the control of active/stand-by condition. And GP2Y0E02B and GP2Y0E03 have the register for active /stand-by state control through I²C communication. When some these sensors are used for the same bus, slave address of I²C can be changed to one of the 16 states by using of E-Fuse. So, it is possible to control some sensors via I²C communication.

7. Response Time

It is possible for this distance measuring sensor to detect the distance from 50cm to 4cm and the reflective object from high reflectance to low reflectance. Detector of this sensor has the function (**) that signal intensity is automatically adjusted in order to detect the reflection with wide dynamic range. Time to output the first distance value is changed by the condition of reflective object because it takes time that this auto adjustment function operates, though this sensor outputs measured distance value after first measurement. Response time defined in electro-optical characteristic of the specification sheet means maximum time to operate auto adjustment function. Digital output (I²C bus) keeps maximum distance of output (64cm) and analog output is 0V till first measurement is completed. It takes approx 2ms to stabilize Vout(A) because analog output has built-in Low-Pass filter in the board. Response time of specification includes this stabilization time of analog output.

If operating condition such as signal accumulation and median filter is changed, response time is not satisfied with one defined in specification sheet. Please refer to 11-2 maximum pulse width of emitting and 11-3 signal accumulation for the change of operating condition.

(**)The function that measurement is repeated while adjusting gain etc of signal processing circuit till signal intensity becomes suitable level for distance calculation. After adjustment to become suitable level of signal intensity, distance measurement starts. (Refer to Fig.22)

8. Ambient Temperature Characteristic

Operating temperature range of GP2Y0E series is maximum +60°C and minimum -10°C. Fig.17 shows that reference data of ambient temperature dependence of digital (I²C bus) and analog output in case of white reflector (R=90%, matt) is placed at 50cm from sensor. This characteristic is reference data measured by the arbitrarily extracted sample and not guaranteed.

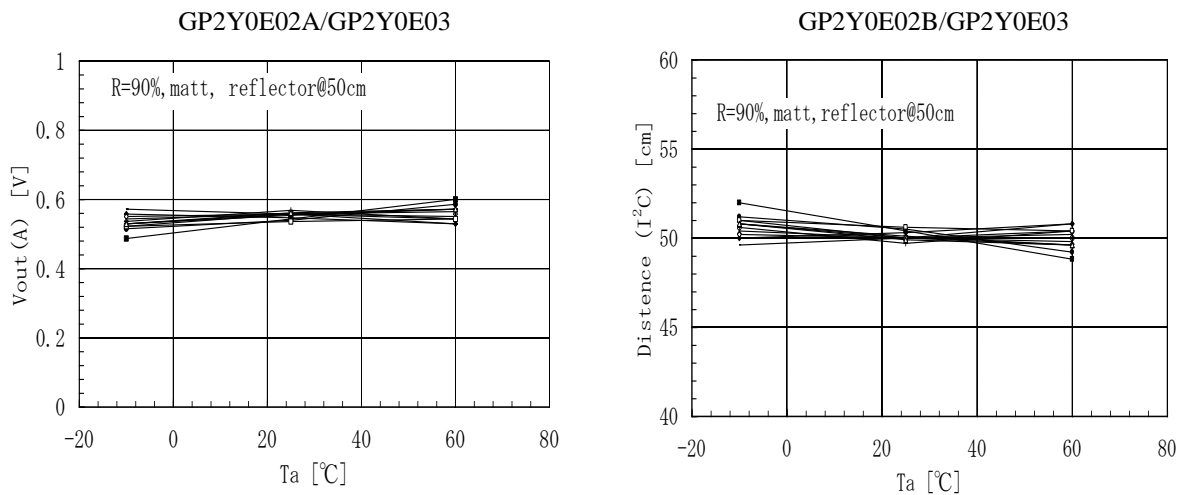

Fig.17 Example of ambient temperature characteristic

9. Ambient Light Characteristic

GP2Y0E series have the function to remove light by the cancellation function of ambient light, a visible light cut lens, etc. Fig.17 shows the reference data of ambient light characteristic for digital (I²C bus) and analog output. Reflective object (R=90%, matt) is placed at the distance of 50cm from the sensor. Ambient light is irradiated at same point with emitting beam of sensor at the angle of 45 degrees as shown in Fig.18. Ambient source of Halogen Lamp (Toshiba lighting & technology corporation) is used in this measurement. The source has similar spectrum of sunlight. Each outputs of Fig.19 are the maximum, average and minimum in 100 times measurement for a same sample, respectively. The illuminance is measured on the surface of reflective object. This characteristic is reference data measured by the arbitrarily extracted sample and not guaranteed.

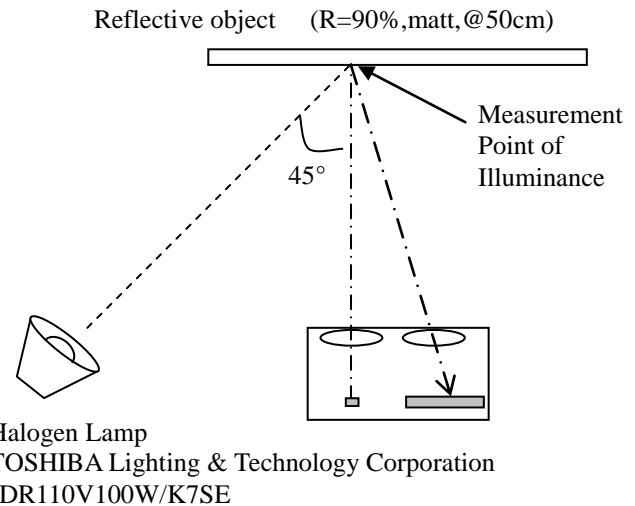

Fig.18 Apparatus of ambient light characteristic measurement

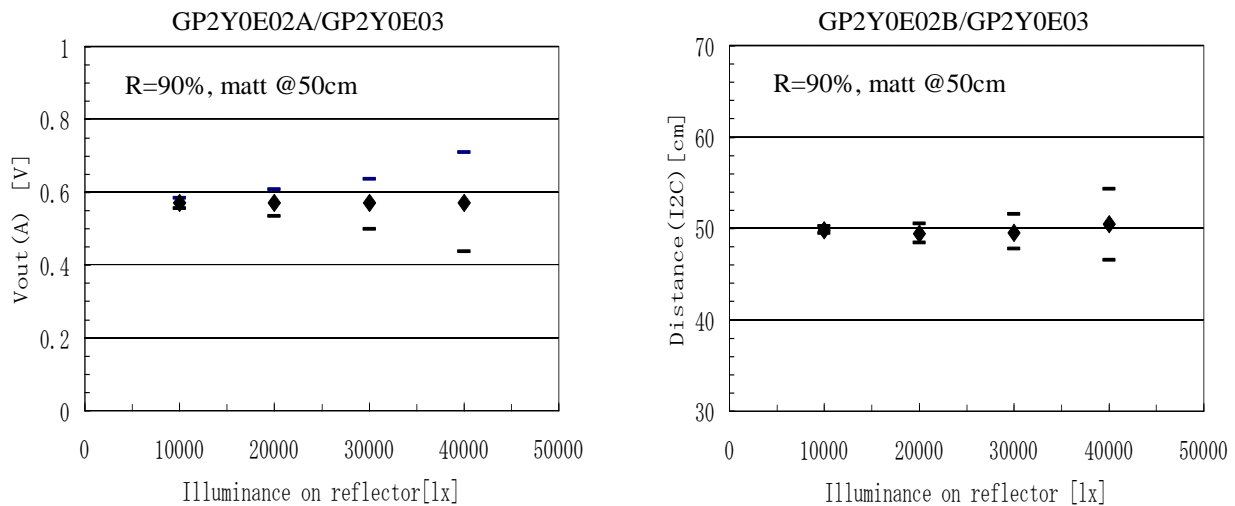

Fig.19 Ambient Light Characteristic

GP2Y0E series have the function to remove ambient light. But when the detector receives direct light from the sun, tungsten lamp and so on, there are cases that it can not measure the distance exactly. Please consider the design that the detector does not receive direct light from such light source. When you operate the customer's set installing this product by the remote control, please consider that the output of this product being disregarded at the time of remote control operation by software.

10. I²C Interface

GP2Y0E series have 7 bits slave address which comply with I²C bus standard (max 400kHz), so a measured distance value can be read through I²C bus. This besides, this product can change register value for each function through I²C bus. GP2Y0E02B and GP2Y0E03 have SCL and SDA terminal in the connector terminal. GP2Y0E02A has SCL and SDA open pad on the back face of board (refer to Fig.37) in order to use it when cover compensation coefficient is programmed in E-Fuse.

Table.06 I²C bus terminal

Name	Description
SCL	I ² C clock
SDA	I ² C data bus

10-1 I²C data transfer format

Symbols explaining read and write format of GP2Y0E series are shown in the Table.07.

Table.07 Symbol of I²C

Symbol	Description	Note
S	Start	Master output
A	ACK	Master/Slave output
NA	NACK	Master/Slave output
P	Stop	Master output
Address	Register address	Master output
Data	Data	Master/Slave output

10-2 Write format

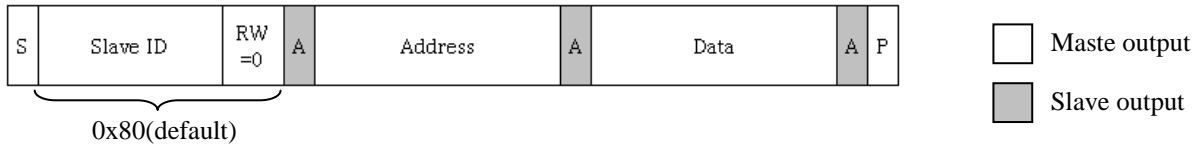

1. Master generates start condition.
2. Master places 1st byte data that include slave address (7bit) with a read/write control bit.
3. Slave issues acknowledgment.
4. Master places 2nd byte address data on SDA.
5. Slave issues acknowledgment.
6. Master places 8 bits data on SDA.
7. Slave issues acknowledgement.
8. Master generates a stop condition to end this write cycle.

10-3 Read format

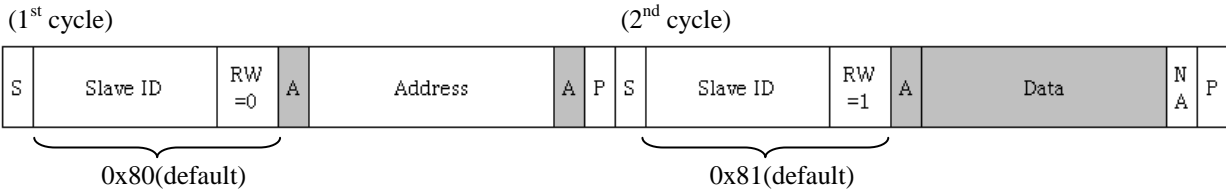

1st cycle

1. Master generates a start condition.
2. Master places 1st byte data that are combined slave address (7bits) with a read/write control bit (R/W=0) to SDA.
3. Slave issues acknowledgement.
4. Master places 2nd byte address data on SDA.
5. Slave issues acknowledgement.
6. Master generates a stop condition to end 1st cycle.

2nd cycle

7. Master generates a start condition.
8. Master places 1st byte data that are combined slave address (7bits) with a read/write control bit (R/W=1) to SDA.
9. Slave issues acknowledgement.
10. 8 bits data is read from internal control register of this product which address was assigned by 1st cycle.
11. Master generates negative acknowledgement.
12. Master generates a stop condition to end this read cycle.

GP2Y0E series supports the continuation read-out function (Burst-Read), so it can read register value from specified address (8.) by ACK that Master transmits (11.). When read-out of data is stopped, Master transmits NACK. Since it don't need to specify address, it is possible to shorten time reading register value. Also Since this product supports Repeat-Start function, it is able to skip (6.) process. Since I²C bus is not opened between 1st cycle and 2nd cycle by skipping (6.), cross talk can be prevented also when two or more Master(s) exist on the same bus.

• Burst-Read without repeat start

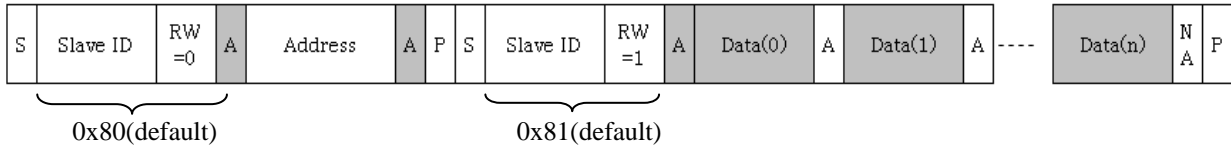

Data(0) is the register value which was assigned by Address. Data(1) and Data(2) are the register value of Address+1 and Address+2, respectively.

• Burst-Read with repeat start

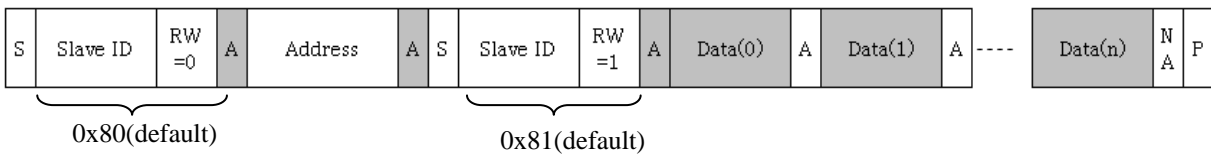

10-4 I²C Bus Timing

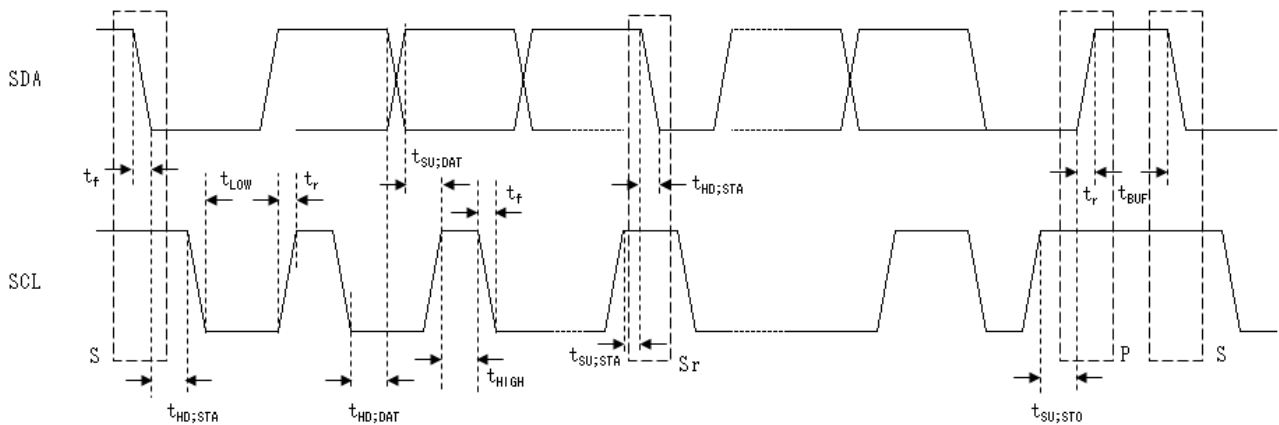

Fig.20 I²C Bus Timing

Table.08 I²C Bus Timing

(Ta = 25°C)

Parameter	Symbol	Min.	Max.	Unit
SCL clock frequency	f _{scl}	-	400	kHz
Hold time for Start/Repeat Start. After this period, the first clock pulse is generated.	t _{HD : STA}	0.6	-	us
Set-up time for a repeated start.	t _{SU : STA}	0.6	-	us
Low period of SCL clock.	t _{LOW}	1.3	-	us
High period of SCL clock	t _{HIGH}	0.6	-	us
Data hold time. For I ² C™-bus device.	t _{HD : DAT}	-	0.9	us
Data set-up time.	t _{SU : DAT}	100	-	ns
Rise time of both SDA and SCL signals.	t _r	-	300	ns
Fall time of both SDA and SCL signals.	t _f	-	300	ns
Set-up time for STOP condition.	t _{SU : STO}	0.6	-	us
Bus free time between a STOP and START.	t _{BUF}	1.3	-	us
Capacitive load for each bus line.	C _b	-	150	pF
Noise margin at LOW level for each connected device.	V _{nL}	0.1VDD	-	V
Noise margin at HIGH level for each connected device.	V _{nH}	0.2VDD	-	V

10-5 I²C DC Timing Characteristic

- GP2Y0E02A/GP2Y0E02B

Table.09 I²C DC Timing Characteristic 1

(Ta = 25°C)

Parameter	Symbol	Standard Mode		Fast Mode		Unit
		Min.	Max.	Min.	Max.	
Low level input voltage	V _{IL}	-0.3	0.3VDD	-0.3	0.3VDD	V
High level input voltage	V _{IH}	0.7VDD	VDD+0.3	0.7VDD	VDD+0.3	V
Hysteresis of Schmitt trigger inputs	V _{hys}	-	-	0.05VDD	-	V
Low level output voltage (open drain of open collector) at 3mA sink current	V _{OL}	0	0.4	0	0.4	V
Output fall time from VIHmin to VILmax with a bus capacitance from 10pF to 400pF	T _{OF}	-	250	-	250	ns
Pulse width of spikes which must be suppressed by the input filter	t _{SP}	-	-	0	50	ns
Input current each I/O pin with an input voltage between 0.1VDD and 0.9VDDmax	I _I	-10	10	-10	10	uA

- GP2Y0E03

Table.10 I²C DC Timing Characteristic 2

(Ta = 25°C)

Parameter	Symbol	Standard Mode		Fast Mode		Unit
		Min.	Max.	Min.	Max.	
Low level input voltage	V _{IL}	-0.3	0.3VIN(IO)	-0.3	0.3VIN(IO)	V
High level input voltage	V _{IH}	0.7VIN(IO)	VIN(IO)+0.3 3.9	0.7VIN(IO)	VIN(IO)+0.3 3.9	V V
Hysteresis of Schmitt trigger inputs VIN(IO) > 2V VIN(IO) < 2V	V _{hys}	-	-	0.05VIN(IO)	-	V
		-	-	0.1VIN(IO)	-	V
Low level output voltage (open drain of open collector) at 3mA sink current VIN(IO) > 2V VIN(IO) < 2V	V _{OL}	0	0.4	0	0.4	V
		-	-	0	0.2VIN(IO)	V
Output fall time from VIHmin to VILmax with a bus capacitance from 10pF to 400pF	T _{OF}	-	250	-	250	ns
Pulse width of spikes which must be suppressed by the input filter	t _{SP}	-	-	0	50	ns
Input current each I/O pin with an input voltage between 0.1VIN(IO) and 0.9VIN(IO)max	I _I	-10	10	-10	10	uA

10-6 Register Map

Bank0 is register band for digital function control Bank3 is E-Fuse mapped register bank. Register 0xEF is used to switch target register bank for register access. Setting 0x00 in the register 0xEF access to bank0, and setting 0x03 access to bank3.

Table.11 Register Map (Bank0)

Address (Hex)	Register Name	Reg Field	Default	R/W	Description
-	Slave ID (write cycle)	-	0x80	R	-
-	Slave ID (read cycle)	-	0x81	R	-
0x03	Hold Bit	[0]	0x01	R/W	0x00=Hold 0x01=Device enable normally Register avoid update during Hold.

0x13	Maximum Emitting Pulse Width	[2:0]	0x07	R/W	0x07=320us, 0x06=240us, 0x05=160us, 0x04=80us, 0x03=40us
0x1C	Spot Symmetry Threshold	[4:0]	0x0E	R/W	-
0x2F	Signal Intensity Threshold	[6:0]	-	R/W	Default is set in each sensor by E-Fuse.
0x33	Maximum Spot Size Threshold	[7:0]	0x7F	R/W	-
0x34	Minimum Spot Size Threshold	[6:0]	-	R/W	Default is set in each sensor by E-Fuse.
0x35	Shift Bit	[2:0]	0x02	R/W	0x01=Maximum Display 128cm 0x02=Maximum Display 64cm
0x3F	Median Filter	[5:4]	0x30	R/W	0x00= Data number of median calculation 7 0x10= Data number of median calculation 5 0x20= Data number of median calculation 9 0x30= Data number of median calculation 1
0x4C	SRAM Access	[4]	-	W	0x10=Access SRAM
0x5E	Distance[11:4]	[7:0]	-	R	Distance Value =(Distance[11:4]*16+Distance[3:0])/16/2^n n : Shift Bit (Register 0x35)
0x5F	Distance[3:0]	[3:0]	-	R	
0x64	AE[15:8]	[7:0]	-	R	AE=AE[15:8]*256 + AE[7:0] Before read out, it need to write Address(0xEC) = Data(0xFF)
0x65	AE[7:0]	[7:0]	-	R	
0x67	AG[7:0]	[7:0]	-	R	Before read out, it need to write Address(0xEC) = Data(0xFF)
0x8D	Cover Compensation[5:0]	[7:2]	0x00	R/W	Cover compensation coefficient = Cover Comp.[10:6]*64 + Cover Comp.[5:0] Cover Comp.[5:0] is assigned in Reg Field[7:2] of register 0x8D. So, it need to shift 2 bits toward right.
0x8E	Cover Compensation[10:6]	[4:0]	0x00	R/W	
0x8F	Cover Compensation Enable Bit	[1:0]	0x03	R/W	0x02=Enable 0x03=Disable
0x90	Read out Image Sensor Data	[4:0]	0x00	R/W	0x00=Disable 0x10=Low Level (L) 0x11=Middle Level (M) 0x12=High Level (H) Intensity=H*65536 + M*256 + L
0xA8	Signal Accumulation Number	[1:0]	0x03	R/W	0x00=1 time accumulation 0x01=5 times accumulation 0x02=30 times accumulation 0x03=10 times accumulation
0xBC	Enable Bit (Signal Intensity)	[0]	0x00	R/W	0x00=enable (Default) 0x01=disable
0xBD	Enable Bit (Minimum spot size)	[0]	0x00	R/W	0x00=enable (Default) 0x01=disable
0xBE	Enable Bit (Maximum spot size)	[0]	0x01	R/W	0x00=enable 0x01=disable (Default)
0xBF	Enable Bit (Spot symmetry)	[0]	0x00	R/W	0x00=enable (Default) 0x01=disable
0xC8	E-Fuse Target Address	[5:0]	0x80	R/W	Specify E-Fuse address in the target bank. Ex. A[0]=0x00, B[10]=0x0A, C[63]=0x3F
	E-Fuse Read Out	[6]			1=load E-Fuse data to Register (Bank3)
	E-Fuse Enable Bit	[7]			0=Enable, 1=Disable
0xC9	E-Fuse Bit Number E-Fuse Bank Assign	[7:0]	0x00	R/W	Assign bit number in the register 0xC9 [7:4] Assign bank select in the register 0xC9 [3:0]. 1:BankA, 2:BankB, 3:BankC, 4:BankD, 5:BankE
0xCA	E-Fuse Program Enable Bit	[0]	0x00	R/W	0x00=Disable 0x01=Enable
0xCD	E-Fuse Program Data	[7:0]	0x00	R/W	-

0xE8	Active/Stand-by State Control	[0]	0x00	R/W	0x00=Active state 0x01=Stand-by state
0xEC	Clock Select	[7:0]	0x00	R/W	0x7F=auto clock 0xFF>manual clock
0xEE	Software Reset	[2:1]	-	W	0x06=software reset
0xEF	Bank Select	[1:0]	0x00	R/W	0x00=Bank0 0x03=Bank3 (E-Fuse)
0xF8	Right Edge Coordinate (C)	[7:0]	-	R	Spot Size = C - A (=0xF8[7:0] - 0xF9[7:0]) Spot Symmetry= (C - A) - 2*B (= (0xF8[7:0] - 0xF9[7:0]) - 2*0xFA[7:0])
0xF9	Left Edge Coordinate (A)	[7:0]	-	R	
0xFA	Peak Coordinate (B)	[7:0]	-	R	

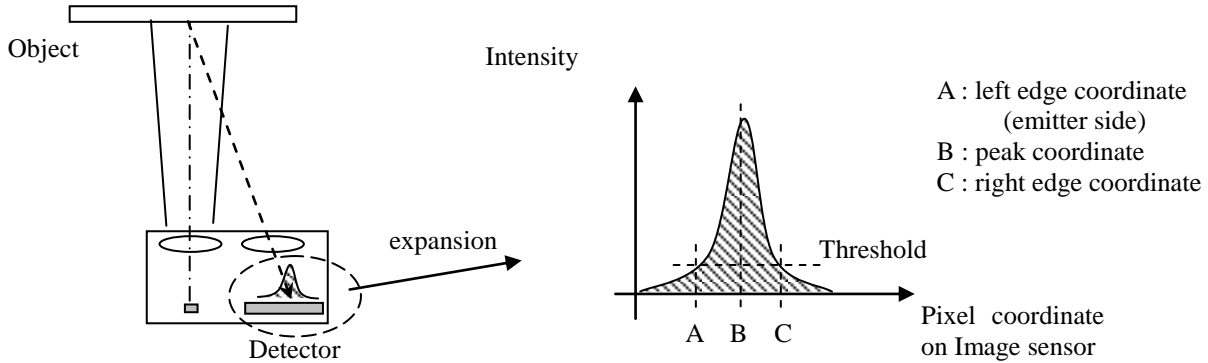

Fig.21 Coordinate of spot profile

Table.12 Register Map (Bank3)

Address (Hex)	Register Name	Bit Select	Address (Hex)	Register Name	Bit Select	Address (Hex)	Register Name	Bit Select
0x00	A[63:56]	[7:0]	0x0E	B[15:8]	[7:0]	0x1C	D[31:24]	[7:0]
0x01	A[55:48]	[7:0]	0x0F	B[7:0]	[7:0]	0x1D	D[23:16]	[7:0]
0x02	A[47:40]	[7:0]	0x10	C[63:56]	[7:0]	0x1E	D[15:8]	[7:0]
0x03	A[39:32]	[7:0]	0x11	C[55:48]	[7:0]	0x1F	D[7:0]	[7:0]
0x04	A[31:24]	[7:0]	0x12	C[47:40]	[7:0]	0x20	E[63:56]	[7:0]
0x05	A[23:16]	[7:0]	0x13	C[39:32]	[7:0]	0x21	E[55:48]	[7:0]
0x06	A[15:8]	[7:0]	0x14	C[31:24]	[7:0]	0x22	E[47:40]	[7:0]
0x07	A[7:0]	[7:0]	0x15	C[23:16]	[7:0]	0x23	E[39:32]	[7:0]
0x08	B[63:56]	[7:0]	0x16	C[15:8]	[7:0]	0x24	E[31:24]	[7:0]
0x09	B[55:48]	[7:0]	0x17	C[7:0]	[7:0]	0x25	E[23:16]	[7:0]
0x0A	B[47:40]	[7:0]	0x18	D[63:56]	[7:0]	0x26	E[15:8]	[7:0]
0x0B	B[39:32]	[7:0]	0x19	D[55:48]	[7:0]	0x27	E[7:0]	[7:0]
0x0C	B[31:24]	[7:0]	0x1A	D[47:40]	[7:0]			
0x0D	B[23:16]	[7:0]	0x1B	D[39:32]	[7:0]			

11. Functions which is possible to be set

GP2Y0E series has 7 bits slave address which complies with I²C bus standard (max400kHz), so various functions of this product can be set by changing register value. Besides, GP2Y0E series has E-Fuse which is a nonvolatile OTP (One Time Programmable Memory), so various functions of this product can be set by programming E-Fuse. In case power supply of this sensor is OFF, this sensor keeps some programs that is written in E-Fuse. So when power supply is ON again, this sensor operates under the programmed condition as before.

Table.13 shows the list of functions which can be set in GP2Y0E series.

Table.13 Functions which can be set by programming E-Fuse and through I²C bus

No	Description	E-Fuse	I ² C	Default (Recommand) Value	Affected Characteristic
1	Slave Address	○	×	Write : 0x80 Read : 0x81	-
2	Maximum Pulse Width of Emitting	○	○	320us	Operating Average Current Stability of Distance Output
3	Signal Accumulation	○	○	10	Response Time Stability of Distance Output
4	Median Filter	○	○	1	Response Time Stability of Distance Output
5	Cover Compensation	○	○	Disable	Distance Characteristic
6-1	Error Judgment (Signal Intensity)	Configured	○	Individual value	Distance Characteristic
6-2	Error Judgment (Minimum spot size)	Configured	○	Individual value	Distance Characteristic
6-3	Error Judgment (Maximum spot size)	○	○	Disable	Distance Characteristic
6-4	Error Judgment (Spot Symmetry)	Configured	○	14	Distance Characteristic
7	Maximum Output Distance	Configured	○	64cm	Analog Output
8	Active/Stand-by State Control	×	○	-	-
9	Software Reset	×	○	-	-

11-1 Slave Address

GP2Y0E02B and GP2Y0E03 can be changed to 16 kinds of slave address in order to avoid overlap with other device connecting with same bus, or when several this products are used connecting with same bus. Please refer to 12-4 (1) I²C slave address with respect to the detail changing method.

Table.14 shows the list of slave address which can be changed.

Table.14 List of Slave Address (GP2Y0E02B、GP2Y0E03)

No	Write Cycle	Read Cycle	Note	No	Write Cycle	Read Cycle	Note
1	0x00	0x01	-	9	0x80	0x81	Default
2	0x10	0x11	-	10	0x90	0x91	-
3	0x20	0x21	-	11	0xA0	0xA1	-
4	0x30	0x31	-	12	0xB0	0xB1	-
5	0x40	0x41	-	13	0xC0	0xC1	-
6	0x50	0x51	-	14	0xD0	0xD1	-
7	0x60	0x61	-	15	0xE0	0xE1	-
8	0x70	0x71	-	16	0xF0	0xF1	-

11-2 Maximum Pulse Width of Emitting

GP2Y0E series have the function which adjust emitting power by detecting signal intensity. Emitting power is adjusted by control of emitting pulse width. Average current consumption decrease by restricting maximum emitting pulse width. However, distance characteristic change, especially distance output may become unstable in case of detecting reflector at far distance and with low reflectance because signal intensity is also decreased by restricting maximum emitting pulse width. Response time does not change even if maximum emitting pulse width is decreased. In case that maximum pulse width of emitting is changed, there is the case that electro optical characteristic described in specification sheet becomes not to be satisfied. Please use it after confirming with customer's product. Table.15 shows the relation between maximum pulse width of emitting (setting value) and operating average current consumption. Please refer to the register 0x13 in register map (bank0) of table.11 with respect to the method of bank0 register setting. And, please refer to 12-4(2) maximum pulse width of emitting with respect to programming in E-Fuse.

Table.15 Maximum pulse width of emitting and operating average current consumption

No	Max. pulse width of emitting (setting value)	Average current consumption	Note
1	320us	Approx. 26mA	Default
2	240us	Approx. 22mA	-
3	160us	Approx. 18mA	-
4	80us	Approx. 14mA	-
5	40us	Approx. 12mA	-

11-3 Signal Accumulation

GP2Y0E series calculate the light spot position after accumulation of several emitting pulse signals and calculate the distance value. Response time can decrease by decreasing of signal accumulation times. However, distance characteristic change, especially the distance output may become unstable in the case of detecting reflector at far distance and the case with low reflectance, because signal intensity is decreased by decreasing signal accumulation times. Response time does not change even if signal accumulation times are decreased. In case that signal accumulation times are changed, there is the case that electro optical characteristic described in specification sheet becomes not to be satisfied. Please use it after confirming with customer's product. Please refer to the register 0xA8 in register map (bank0) of table.11 with respect to the method of bank0 register setting. And, please refer to 12-4(3) signal accumulation with respect to programming in E-Fuse.

Table.16 Signal accumulation times and response time

No	Signal Accumulation Times	Response Time (Max)	Measurement Period	Note
1	1	20ms	Approx. 1.9ms	-
2	5	30ms	Approx. 9.5ms	-
3	10	40ms	Approx. 19ms	Default
4	30	80ms	Approx. 57ms	-

11-4 Median Filter

GP2Y0E series have the median calculation function by using several distance outputs in order to get stable output. Response time increases though distance output becomes stable by using median calculation function. Median calculation number can be selected to 5, 7 or 9. That is, in case of 5, a median of 5 distance values is output after 5 times measurement. This sensor outputs measured distance after first measurement. However, output distance before finishing the measurement times is not the result that median was calculated. Fig.22 shows the example that median filter is set to 5.

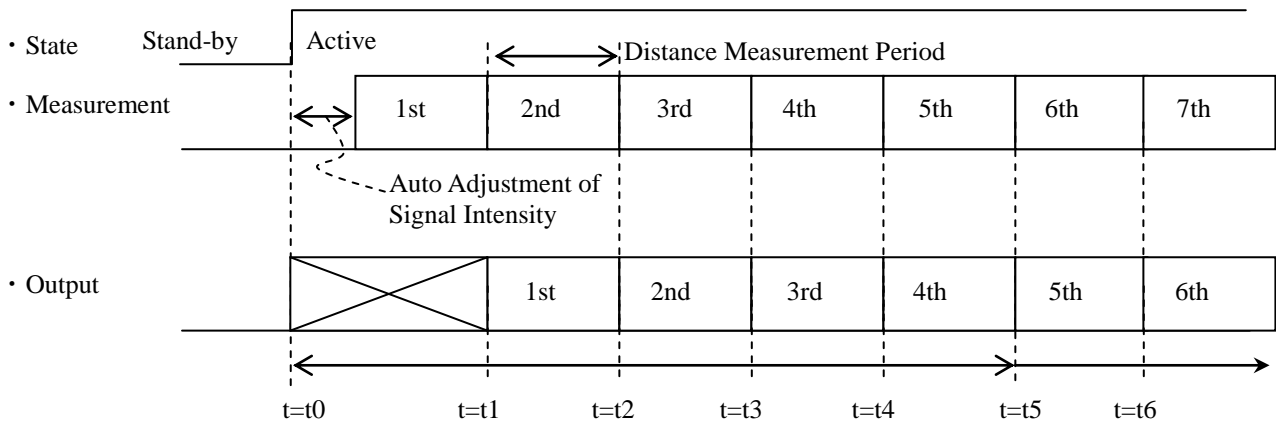

Fig.22 Median Filter

Output from t_0 to t_5 is indefinite value because 5 times measurement is not finished before t_5 . However, there is the case that output before t_5 is same with one after t_5 in the case that signal intensity is enough to be large. 6th output is the median value of 5 times measurements from 2nd measurement to 6th measurement. After that, distance output is updated every one measurement. Measurement period in table.16 is defined as one measurement period as shown in Fig.22. Table.17 shows the relation of response time with number of median filter (11-4) and signal accumulation times (11-3). Please refer to the register 0x3F in register map (bank0) of table.11 with respect to the method of bank0 register setting. And, please refer to 12-4(4) Median Filter with respect to programming in E-Fuse. In case that median filter function is turned enable, there is the case that electro optical characteristic described in specification sheet becomes not to be satisfied. Please use it after confirming with customer's product.

Table.17 Median Filter and Response Time

No	Number of data	Response time (signal accumulation)				Note
		(1time)	(5times)	(10times)	(30times)	
1	1	20ms	30ms	40ms	80ms	Default (signal accumulation : 10)
2	5	27ms	70ms	120ms	310ms	-
3	7	30ms	90ms	160ms	430ms	-
4	9	35ms	110ms	200ms	550ms	-

11-5 Cover Compensation

GP2Y0E series have the cover compensation function that distance error generated by direct reflection from protection cover which is set in customer's product is compensated. Only tail of light spot is detected by detector (CMOS image sensor) as shown in Fig.23, because direct reflection from flat protection cover which is set to be parallel to the sensor enters with large incident angle to the detector. On the other hand, whole light spot with peak is formed on the detector by the reflection of reflective object after transmitting protection cover (not shown in Fig.23). Therefore, in case that protection cover is set in front of sensor, light spot profile has the shape of a tilt as shown in Fig.24.

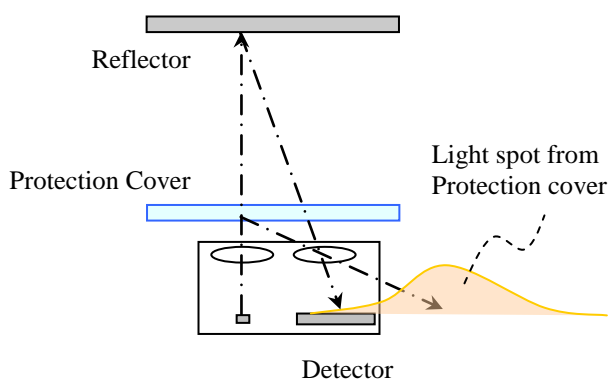

Fig.23 light spot from protection cover

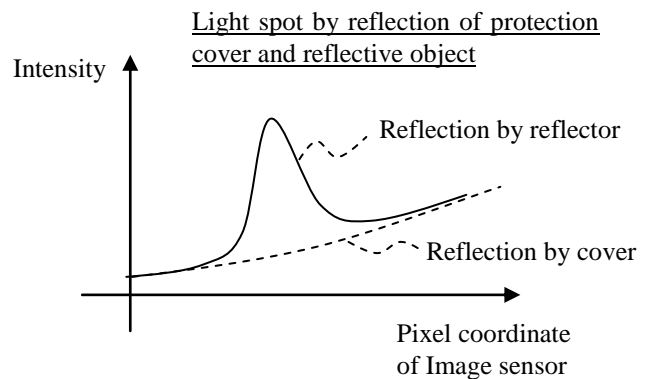

Fig.24 light spot profile of cover and reflective object

Cover compensation function can be adopted under the condition that the light spot profile like Fig.25. Light spot from protection cover is possible to be approximated linearly as shown in Fig.25. The calculated slope of linear approximation is defined as k. k is set in signal circuit of sensor in advance before measurement of distance. Direct reflection from protection cover is removed by subtraction of k from light spot profile before calculation of light spot position. As described above, k is the cover compensation coefficient. Light spot profile that direct reflection from protection cover was subtracted is the light spot profile by only reflection of reflective object as shown in Fig.26. Therefore, distance error by installation of protection cover is decreased.

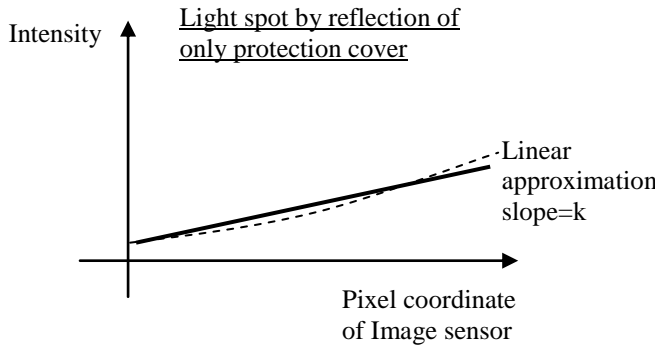

Fig.25 Light spot profile of protection cover

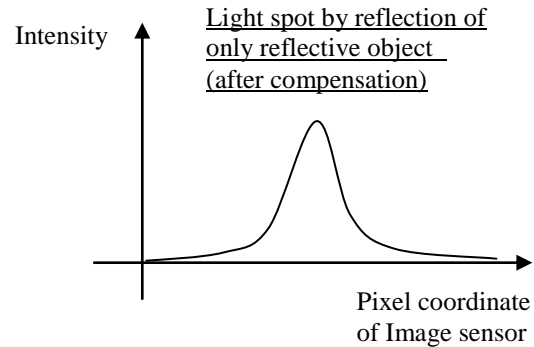

Fig.26 Light spot profile after compensation

Cover compensation function is effective only when light spot profile of direct reflection from protection cover can be approximated linearly. Incident angle of direct reflection from protection cover is decreased as increasing the distance between protection cover and sensor, and it is also decreased as increasing cover thickness. Therefore, distance accuracy is decreased. Also, slope k has different value from the material, shape, installation conditions and so on. There is the case that slope k has different value by dispersion of sensor, even if installation condition is same. It is necessary for customer to decide the compensation coefficient (slope k) to use cover compensation function under the condition that customer's protection cover is installed. Compensation coefficient (slope k) has dispersion by the sensor, protection cover, installation condition and so on.

Fig.27 shows an example of measurement environmental of cover compensation coefficient (slope k) .

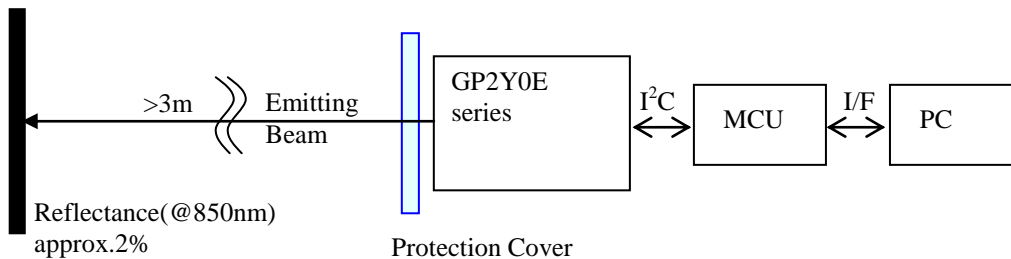

Fig.27 Example of measurement environmental of cover compensation coefficient

Under dark condition, protection cover is installed in front of this sensor at the given position. Black reflective object with around 2% or less reflectance is installed at the distance of 3m or more. Most reflected light does not enter into detector under this condition. So, light spot profile like Fig.25 is detected. Light spot is measured under this condition, and slope k of linear approximation is calculated by the least-square method by using MCU and so on. Below shows the measurement procedure of cover compensation coefficient by using I²C interface.

- Measurement procedure of compensation coefficient
- (01) Data(0x00) is set in Address(0xEF).
- (02) Data(0xFF) is set in Address(0xEC).
- (03) Wait for 4*(N+10) [ms] (N : signal accumulation times)
- (04) Read out data of Address(0x64), and record it as AE[15:8].
- (05) Read out data of Address(0x65), and record it as AE[7:0].
- (06) Calculate $AE = AE[15:8]*256 + AE[7:0]$
- (07) Read out data of Address(0x67), and record it as AG[7:0].
- (08) Calculate $AG = 2^{\frac{AG[7:0]}{16}} * \frac{AG[3:0] + 16}{16}$
- (09) Data(0x00) is set in Address(0x03).

- (10) Wait for $2*(N+10)$ [ms]. (N : signal accumulation times)
 (11) Data(0x10) is set in Address(0x4C).
 (12) Wait for $2*(N+10)$ [ms]. (N : signal accumulation times)
 (13) Data(0x10) is set in Address(0x90). (Read out setting of Low Level Data)
 (14) Read out 220pcs of data with burst read from Address(0x00) to Address(0xDB), and record them as L[1:220].
 Burst Read : refer to 10-3 Read Format
 (15) Data(0x11) is set in Address(0x90). (Read out setting of Middle Level Data)
 (16) Read out 220pcs of data with burst read from Address(0x00) to Address(0xDB), and record them as M[1:220].
 (17) Data(0x12) is set in Address(0x90). (Read out setting of High Level Data)
 (18) Read out 220pcs of data with burst read from Address(0x00) to Address(0xDB), and record them as H[1:220].
 (19) Calculate $profile[1:220] = \frac{8}{AG} * \frac{295}{AE} * (H[1:220] * 65536 + M[1:220] * 256 + L[1:220])$

where, 1 and 220 of profile[1:220] shows X coordinate、Profile[1] shows Y coordinate of X=1.

Profile[1:220] shows the function of $Y=profile[X]$. (refer to Fig.28)

- (20) Data(0x00) is set in Address(0x90).
 (21) Data(0x01) is set in Address(0x03).
 (22) Calculate k by using least-square method from Profile[1:220].

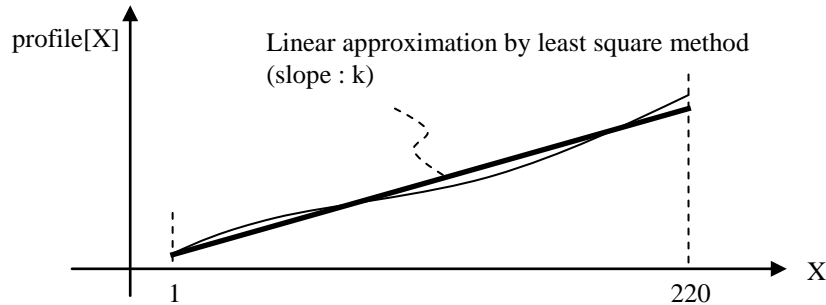

Fig.28 Read out light spot data

Material of protection cover : Acrylic (transmittance>90% @850nm)

Angle between surface and back face of protection cover : parallel

Angle between sensor and protection cover : parallel

Thickness of protection cover : 2mm

Distance between sensor and protection cover : 1mm

Reference value of slope k is around 350 under the above condition. This k value is reference data measured by the arbitrarily extracted sample and not guaranteed. There is the case that it has large difference with the coefficient measured under the customer's condition. Please use it after confirming with customer's product.

In case that k=350 is set in register (bank0), cover compensation [10:0] is separated into cover compensation [5:0] = 0b011110 and cover compensation [10:6] = 0b00101. Cover compensation [5:0] is available in register 0x8D of bank0 and cover compensation [10:6] is available in register 0x8E of bank0 as shown in register map(bank0) of Table.11. Setting value in register 0x8E is 0x05 because cover compensation [10:6] is available in Reg Field [4:0]. However, setting value in register 0x8D is 0x78 because cover compensation [5:0] is available in Reg Field [7:2]. That is, 0b011110 should be shifted left by 2 bits and 0b01111000 (=0x78) is calculated. Moreover, compensated distance value is output after cover compensation function turns enable by setting data (0x02) in register 0x8F. Please refer to 12-4(5) Cover Compensation with respect to the method of programming compensation coefficient in E-Fuse.

11-6 Error Judgment of Distance Measurement

(11-6-1)Signal Intensity

GP2Y0E series have the function that distance output is fixed to 64cm (below 0.2V for the analog output) which is the maximum distance of output in case that signal intensity of reflection is not enough to calculate distance. Because reflective intensity from the distant reflective object is so small, the intensity of light spot becomes very small. Distance accuracy is decreased because light spot position which is calculated from such spot profile is unstable. In order to prevent decrease of distance accuracy like this, the threshold level of signal intensity is already programmed in E-Fuse, and this product outputs the calculated distance only in case signal intensity over threshold is detected. Eigenvalue of the threshold level is programmed in E-Fuse for the each sensor so that error is judged under the same reflection condition.

It is possible to change the threshold level by register setting of bank0, because it is already programmed in E-Fuse at the shipment. It is necessary to set the register again after power (VDD) on when power (VDD) was once turned off, because initial value in E-Fuse is loaded. Setting value in register bank0 is kept by switching active state to stand-by state. So, it is not necessary that register is set again. It is possible to change threshold level by setting given value in register 0x2F of bank0 as shown in Table.11. When VDD turns on, initial value programmed in E-Fuse is loaded in the register 0x2F. Threshold level increases by setting value larger than read out value in register 0x2F. And, this function is enabled in the initial state. Please turn disable by setting 0x01 in register 0xBC when this function is not used. However, when it is disabled, unstable distance is output even if there are no reflection such as infinity. We recommend that you use a certain threshold level is set to enable.

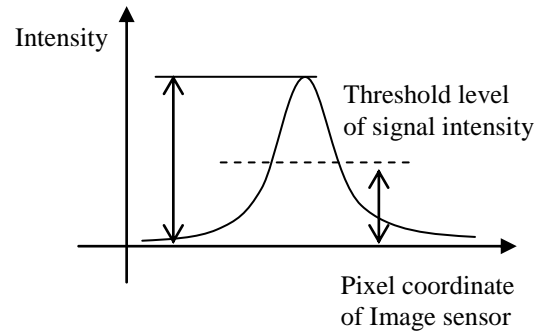

Fig.29 Threshold level of signal intensity

(11-6-2)Minimum Spot Size

GP2Y0E series have the function that distance output is fixed to 64cm (below 0.2V for the analog output) which is the maximum distance of output in case that spot size detected on image sensor is out of specified range. As described in chapter 6-4 and 6-5, there is the case that the shape of light spot is deformed for the case of reflective object with boundary line or partial reflection of emitting. Reflection A with hatching area is shown in Fig.30 for the case of left side partial reflection of emitting, and reflection B (dashed line) is shown for the case of whole reflection with uniform reflectance. In case of whole reflection B, light spot profile is shown as dashed line in Fig.31. On the other hand, in case of partial reflection A, light spot profile of left side is deformed as shown in hatching area of reflection A in Fig.31. Therefore, error of distance measurement generates because light spot position shifts toward right compared with reflection B. In order to prevent decrease of distance accuracy like this, the threshold level of minimum spot size is already programmed in E-Fuse, and this product outputs the calculated distance only in case spot size over minimum threshold is detected. Measurement condition with error can be detected for the case of incomplete spot size, because ϕ_A which generates error is smaller than ϕ_B . Eigenvalue of the spot size threshold is programmed in E-Fuse for the each sensor so that error is judged under the same reflection condition.

It is possible to change the threshold level by register setting of bank0, because it is already programmed in E-Fuse at time of the shipment. It is necessary to set the register again after power (VDD) on when power (VDD) was once turned off, because initial value in E-Fuse is loaded. Setting value in register bank0 is kept by switching active state to stand-by state. So, it is not necessary that register is set again. It is possible to change threshold spot size by setting given value in register 0x34 of bank0 as shown in Table.11. When VDD turns on, initial value programmed in E-Fuse is loaded in the register 0x34. Threshold of spot size increases by setting value larger than read out value in register 0x34. And, this function is enabled in the initial state. Please disable by setting 0x01 in register 0xBD when this function is not used.

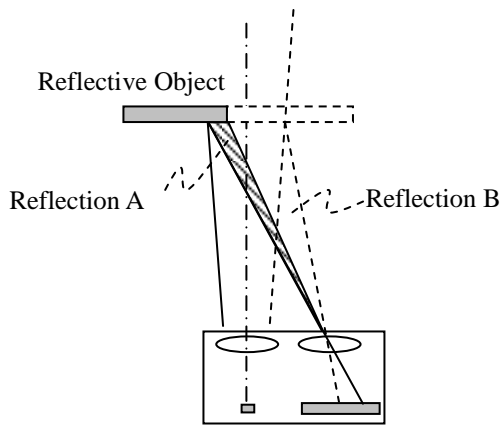

Fig.30 Partial and Whole Reflection of Emitting Beam

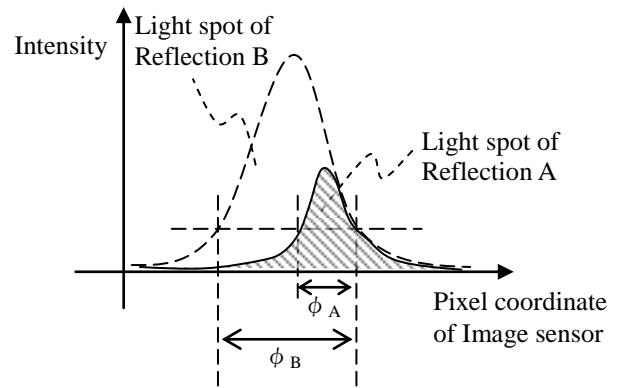

Fig.31 Spot size of partial and whole reflection

(11-6-3)Maximum Spot Size

In addition to minimum spot size threshold described in 11-6-2, maximum spot size threshold also can be set. There is the case that spot size of incomplete reflection such as the reflection from a fraction of emitting beam and the reflection from the reflective object with complex boundary line becomes large by deformed spot profile compared with spot size of normal reflection. Fig.32 shows an example of these reflections. It is possible that calculated distance by using this incomplete spot profile has large distance error. In order to prevent decrease of distance accuracy like this, the maximum threshold of spot size can be set in register of bank0 and programmed in E-Fuse. This product outputs the calculated distance only in case spot size below threshold is detected.

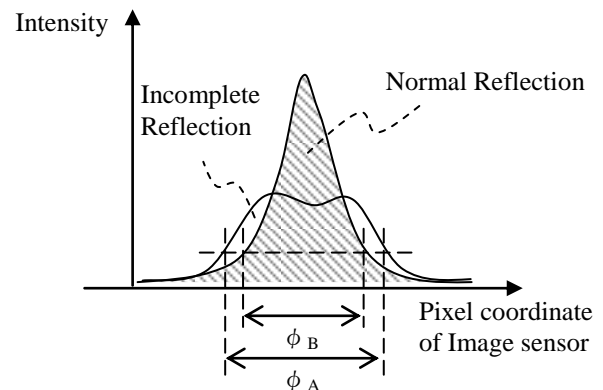

Fig.32 Spot size of incomplete and normal reflection

This threshold is not programmed in E-Fuse at the shipment. This can be programmed in E-Fuse at customer side. And, this also can be set in register of bank0. It is necessary to set the register again after power (VDD) on when power (VDD) was once turned off, because this function operates disable. Setting value in register bank0 is kept by switching active state to stand-by state. It is possible to change threshold spot size by setting given value in register 0x33 of bank0 as shown in Table.11. Threshold spot size increases by setting value larger than read out value in register 0x33. And, this function is disabled in the initial state. Please turn enable by setting 0x00 in register 0xBE when this function is used. Spot size measurement data can be read out from the register 0xF8 and 0xF9. Please refer to 12-4(6) Maximum Spot Size Threshold of Measurement Error Judgment with respect to programming it in E-Fuse.

(11-6-4)Spot Symmetry

GP2Y0E series have the function that distance output is fixed to 64cm (below 0.2V for the analog output) which is the maximum distance of output in case that spot symmetry detected on image sensor is out of specified range. There is the case that the shape of light spot is deformed for the case of reflective object with boundary line and so on. In this case, spot size may be between minimum and maximum threshold of spot size. However, distance output has error because light spot position is shifted in case that Left spot size (ϕ_L) is different with Right spot size (ϕ_R). In order to prevent decrease of distance accuracy like this, the threshold level of spot symmetry (fixed value : 14) is already programmed in E-Fuse, and this product outputs the calculated distance only in case spot symmetry below threshold is detected.

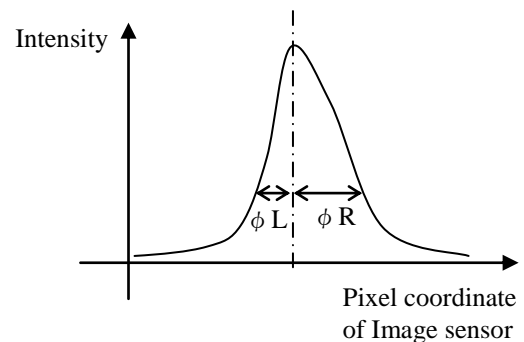

Fig.33 Asymmetric Light Spot

It is possible to change the threshold level by register setting of bank0, because it is already programmed in E-Fuse at the shipment. It is necessary to set the register again after power (VDD) on when power (VDD) was once turned off, because initial value in E-Fuse is loaded. Setting value in register bank0 is kept by switching active state to stand-by state. So, it is not necessary that register is set again. It is possible to change threshold of spot symmetry by setting

given value in register 0x1C of bank0 as shown in Table.11. When VDD turns on, initial value programmed in E-Fuse is loaded in the register 0x1C. Threshold of spot symmetry increases by setting value larger than read out value in register 0x1C, and calculated distance from deformed spot is output. Spot symmetry measurement data can be read out from the register 0xF8, 0xF9 and 0xFA. This function is enabled in the initial state. Please turn disable by setting 0x01 in register 0xBF when this function is not used.

• Correlation between distance detection accuracy and close range distance measurement

As described above, it is possible to decrease the distance measurement error by using each error judgment function. However, threshold value of spot size and spot symmetry affects the close range distance characteristic (below 4cm). Fig.34 shows the example of distance characteristic when the error judgment is enable and Fig.35 shows the example of distance characteristic when the error judgment is disable. When error judgment is used as shown in Fig.34, distance output below 4cm is fixed to 64cm which is maximum distance output even if whole emitting beam is reflected by the reflective object with uniform reflectance, though it depends on threshold value of error judgment. The distance is about 3cm for the case of GP2Y0E series. On the other hand, as shown in Fig.35, measured distance is decreased continuously at the distance below 4cm though it does not have linearity, when error judgment is not used. When reflective object is placed at the distance which is very close to sensor, this sensor outputs maximum distance of 64cm because reflective light does not enter the receiving area. This is because signal intensity is under the threshold level of signal intensity.

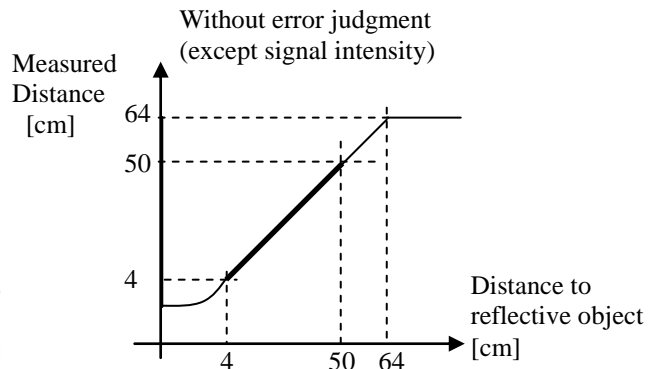
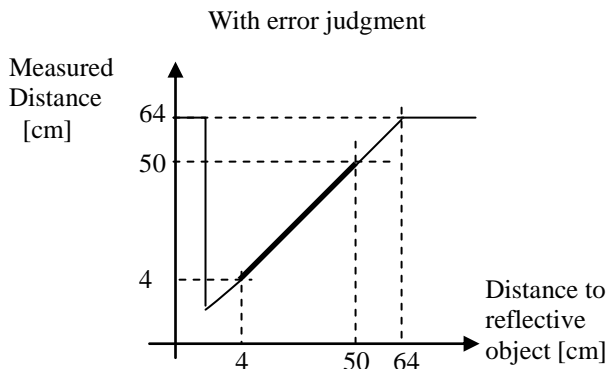

Fig.34 Distance characteristic with error judgment

Fig.35 Distance characteristic without error judgment

In this way, there is the case that distance measurement is fixed to 64cm as error by the judgment of light spot size or symmetry threshold, when the reflective object is very close to sensor.

Fig.36 shows the flow-chart of each error judgment described in chapter 11-6. Enable bit is installed in each error judgment function. Each function can be selected to enable or disable by this bit. These error judgment functions of GP2Y0E series are enable except maximum spot size threshold. So, maximum spot size error judgment is skipped.

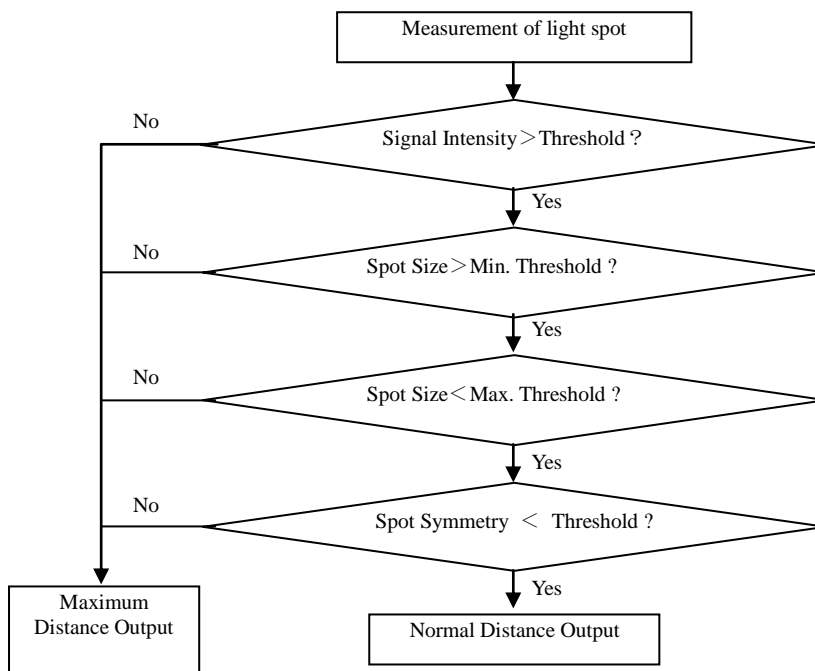

Fig.36 Flow-Chart of error judgment

There is the case that electro-optical characteristic described in specification sheet is not satisfied if threshold value of each error judgment is changed and if error judgment is added or removed. Please use it after confirming best output for customer's product.

11-7 Maximum Output Distance

Maximum output distance of GP2Y0E02B and GP2Y0E03 is 64cm, however it can be changed to 128cm by setting register. Distance characteristic of digital output in specification is not changed, though maximum output distance can be changed. Please use it after confirming output for customer's product with respect of distance accuracy of the far distance of 50cm, because it is not guaranteed in specification.

Distance output from far distance is unstable because reflection is too small. There is the possibility that output distance can be stable by increasing signal accumulation (refer to 11-3) and setting median filter (refer to 11-4). However, pay attention with respect to using of analog output (Vout(A) terminal), because maximum output distance cannot be used in case that it is changed. Please refer to address 0x35 (bank0) of Table.11 with respect to setting register.

11-8 Active/Stand-by State Control

Active and Stand-by state of GP2Y0E02A and GP2Y0E03 can be changed by input voltage in GPIO1 terminal. It turns to active state by input H level in GPIO1 terminal, it turns to stand-by state by input L level. H and L voltage level is decided by input voltage to VIN(IO) terminal. Please be attention in wiring of VIN(IO) in case that VDD is over 3.6V because VIN(IO) cannot be connected to VDD. For example of VDD=5V, it is necessary of another input voltage below 3.6V. Active and stand-by state can be changed by connecting GPIO1 to VDD and GND because VIN(IO) is connected to VDD in PCB board.

Moreover, active and stand-by state of GP2Y0E02B and GP2Y0E03 can be changed by register setting. It is necessary of H level input voltage to GPIO1 terminal. Please refer to address 0xE8 (bank0) of Table.11 with respect to register setting. Please refer to 4-2 with respect to timing of active/stand-by state change.

11-9 Software Reset

Register value which is set individually is cleared and all register value can be reset to initial value (setting value in E-Fuse) by executing software reset. Procedure of software reset is shown in below.

- (1) Data=0x00 is set in Address=0xEF.
- (2) Data=0xEF is set in Address=0xEC.
- (3) Data=0x06 is set in Address=0xEE.
- (4) Data=0x7F is set in Address=0xEC.

12. E-Fuse Programming

E-Fuse is a nonvolatile memory which is possible to write program only one time. So it is able to change some settings of this sensor by E-Fuse programming, Also compensation function can be active by E-Fuse programming. In case power supply of this sensor is OFF, this sensor keeps some programs that is written in E-Fuse. So when power supply is ON again, this sensor operates under the programmed condition as before.

12-1 Set-up for Programming

Fig.37 is the basic set-up to program data in E-Fuse.

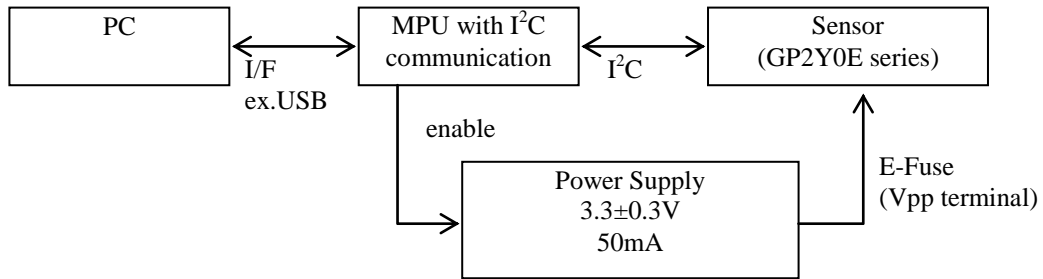

Fig.37 Block Diagram of E-Fuse Programming Environment

PC is used when different data is programmed to each sensor. It is unnecessary when same data which was set in MPU is programmed. V_{pp} terminal is on the back side of this sensor as shown in Fig.35. SCL and SDA terminal are prepared in back side of GP2Y0E02A, because their terminals are necessary to program in E-Fuse. (Refer to Fig.38)

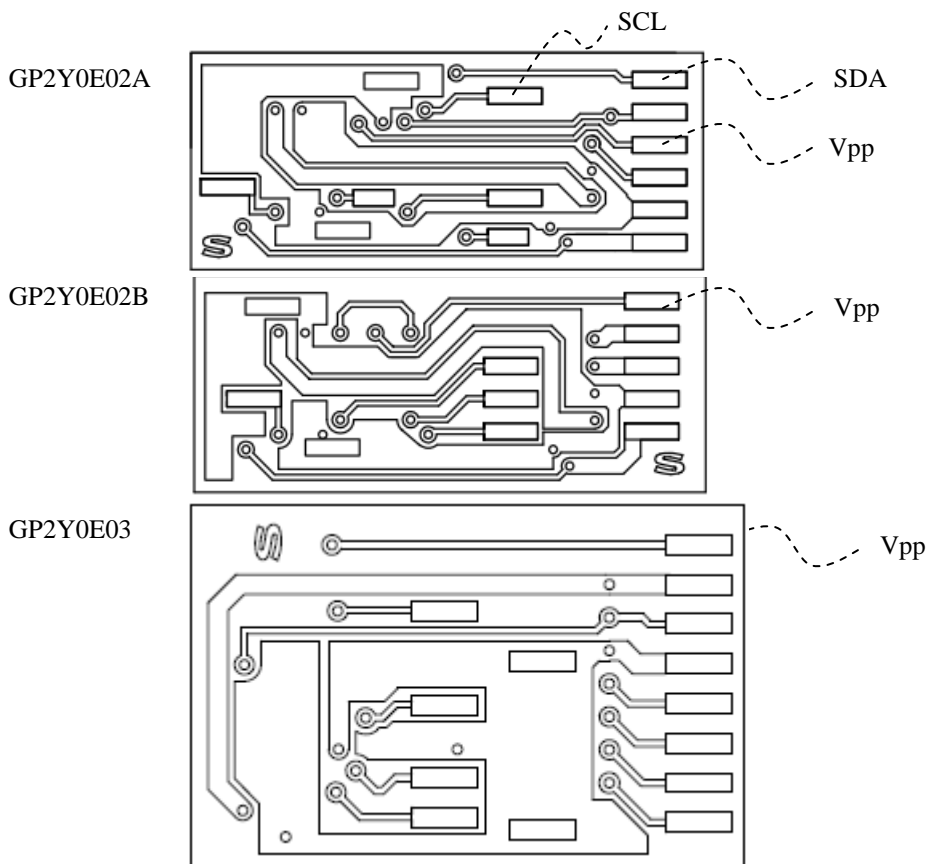

Fig.38 Back side of Board

12-2 Electrical Specification

12-2-1) Power Requirement

Table.18 Power requirement of Vpp

Vpp	Min.	Typ.	Max.	Unit
Voltage	3.0	3.3	3.6	V
Current	50	—	—	mA

12-2-2) Power Timing

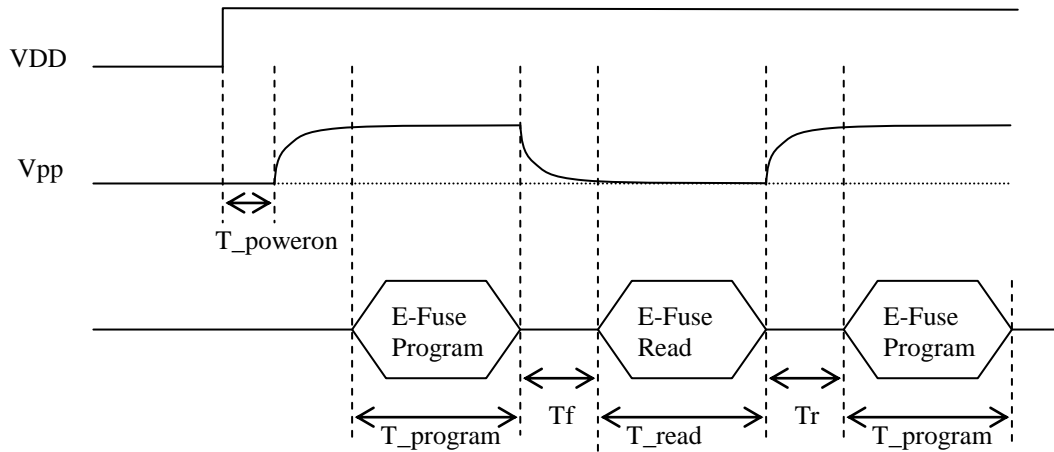

Fig.39 Power Timing of Vpp

T_{poweron}: E-Fuse power should be turn on 1ms later than VDD is applied.

T_f: E-Fuse power falling time.

T_{program}: Programming time. (from stage5 to stage6 in Fig.40)

T_{read}: Read time depends on how many bits are read.

T_r: E-Fuse power rising time.

12-3 Program Flow

E-Fuse program through I²C is byte base (8bits can be programmed at one programming cycle), if more than 8bits need to be programmed, two or more cycles are necessary. Fig.40 is program flow chart.

The list of setting value in E-Fuse for each function (Table.13) is shown in Table.20. Please refer to it when you program E-Fuse at each stage in Fig.40.

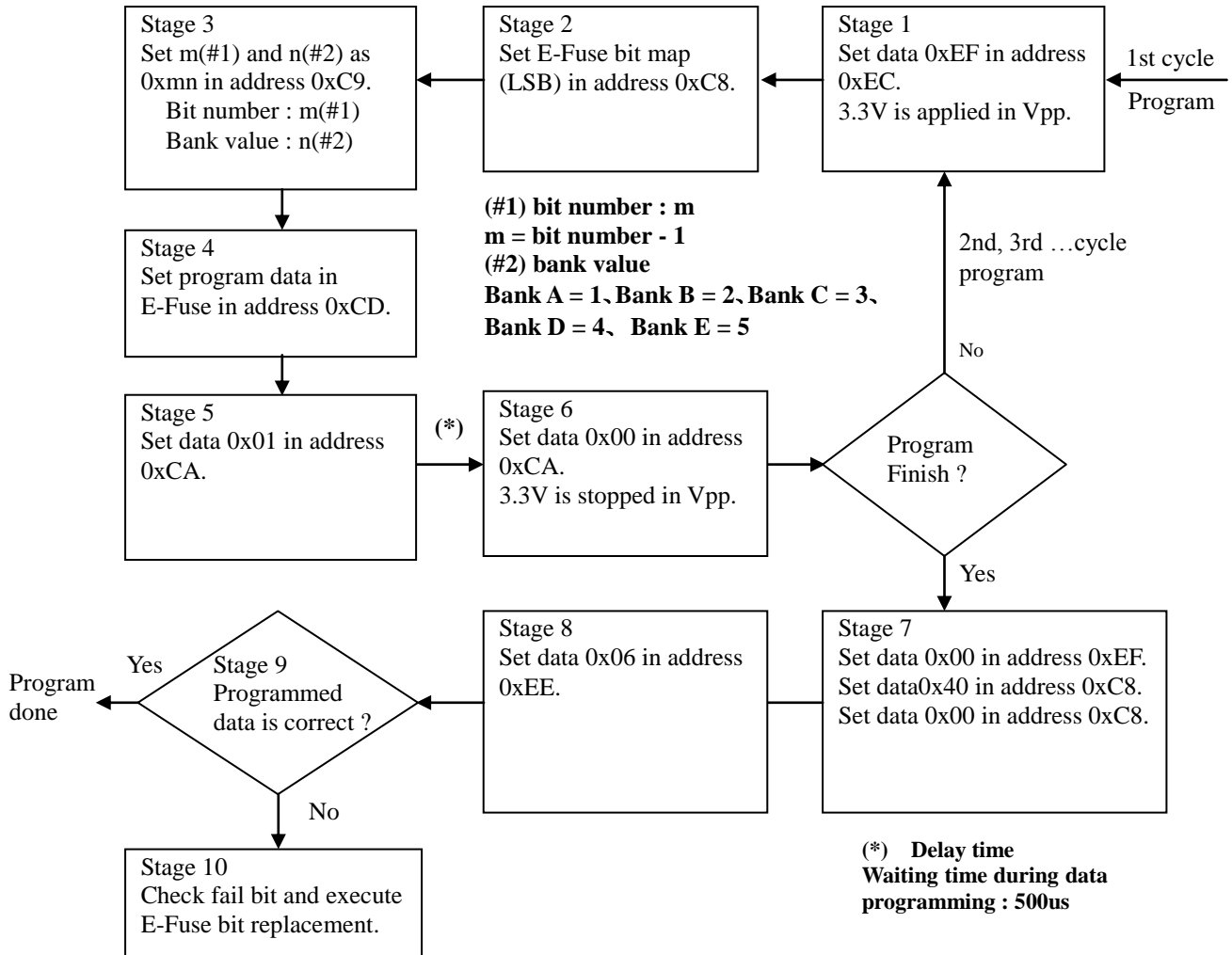

Fig.40 E-Fuse Program Flow

12-4 E-Fuse Bit Map

There are 5 blocks (Bank A, Bank B, Bank C, Bank D and Bank E) in this sensor. Each block has 64bits. Initial value of each bit is 1. Setting value, operation condition, compensation function and so on of below six items can be changed by programming specified bit shown in Table.19 to 0. It may not be satisfied with the specification of the electro-optical characteristic in case that compensation function turns enable or operation condition is changed. Please use it after confirming with customer's product.

E-Fuse bit map is shown in Table.19. Mapped Reg in Table.19 is the address in the bank3 register. (refer to Table.12)

Table.19A Bank A

Bit Map	A[0]	A[1]	A[2]	A[3]	A[4]	A[5]	A[6]	A[7]	A[8]	A[9]	A[10]	A[11]	A[12]	A[13]	A[14]	A[15]
item	×	×	×	×	×	×	×	×	×	×	×	×	×	×	×	×
Mapped Reg	not use								not use							
Bit Map	A[16]	A[17]	A[18]	A[19]	A[20]	A[21]	A[22]	A[23]	A[24]	A[25]	A[26]	A[27]	A[28]	A[29]	A[30]	A[31]
item	Max. Puls Width			Accumulation		×	×	×	×	×	×	×	×	×	×	×
Mapped Reg	0x05								not use							
Bit Map	A[32]	A[33]	A[34]	A[35]	A[36]	A[37]	A[38]	A[39]	A[40]	A[41]	A[42]	A[43]	A[44]	A[45]	A[46]	A[47]
item	×	×	×	×	×	×	×	×	×	×	×	×	×	×	×	×
Mapped Reg	not use								not use							
Bit Map	A[48]	A[49]	A[50]	A[51]	A[52]	A[53]	A[54]	A[55]	A[56]	A[57]	A[58]	A[59]	A[60]	A[61]	A[62]	A[63]
item	×	×	×	×	×	×	×	×	×	×	×	×	×	×	×	×
Mapped Reg	not use								not use							

Table.19B Bank B

Bit Map	B[0]	B[1]	B[2]	B[3]	B[4]	B[5]	B[6]	B[7]	B[8]	B[9]	B[10]	B[11]	B[12]	B[13]	B[14]	B[15]
item	×	×	×	×	×	×	×	×	×	×	×	×	×	×	×	×
Mapped Reg	not use								not use							
Bit Map	B[16]	B[17]	B[18]	B[19]	B[20]	B[21]	B[22]	B[23]	B[24]	B[25]	B[26]	B[27]	B[28]	B[29]	B[30]	B[31]
item	×	×	×	×	×	×	×	×	×	×	×	×	×	×	×	×
Mapped Reg	not use								not use							
Bit Map	B[32]	B[33]	B[34]	B[35]	B[36]	B[37]	B[38]	B[39]	B[40]	B[41]	B[42]	B[43]	B[44]	B[45]	B[46]	B[47]
item	×	×	×	×	×	×	×	×	×	×	×	×	×	×	×	×
Mapped Reg	not use								not use							
Bit Map	B[48]	B[49]	B[50]	B[51]	B[52]	B[53]	B[54]	B[55]	B[56]	B[57]	B[58]	B[59]	B[60]	B[61]	B[62]	B[63]
item	×	×	×	×	×	×	×	×	×	×	×	×	×	×	×	×
Mapped Reg	not use								not use							

Table.19C Bank C

Bit Map	C[0]	C[1]	C[2]	C[3]	C[4]	C[5]	C[6]	C[7]	C[8]	C[9]	C[10]	C[11]	C[12]	C[13]	C[14]	C[15]
ite	×	×	×	×	×	×	×	×	×	×	×	×	×	×	×	×
Mapped Reg	not use								not use							
Bit Map	C[16]	C[17]	C[18]	C[19]	C[20]	C[21]	C[22]	C[23]	C[24]	C[25]	C[26]	C[27]	C[28]	C[29]	C[30]	C[31]
item	×	×	×	×	×	×	×	×	×	×	×	×	×	×	×	×
Mapped Reg	not use								not use							
Bit Map	C[32]	C[33]	C[34]	C[35]	C[36]	C[37]	C[38]	C[39]	C[40]	C[41]	C[42]	C[43]	C[44]	C[45]	C[46]	C[47]
item	×	×	×	×	×	×	×	×	×	×	×	×	×	×	×	×
Mapped Reg	not use								not use							
Bit Map	C[48]	C[49]	C[50]	C[51]	C[52]	C[53]	C[54]	C[55]	C[56]	C[57]	C[58]	C[59]	C[60]	C[61]	C[62]	C[63]
item	×	×	×	Cover Compensation												
Mapped Reg	0x11								0x10							

Table.19D Bank D

Bit Map	D[0]	D[1]	D[2]	D[3]	D[4]	D[5]	D[6]	D[7]	D[8]	D[9]	D[10]	D[11]	D[12]	D[13]	D[14]	D[15]
item	×	×	×	×	×	×	×	×	×	×	×	×	×	×	×	×
Mapped Reg	not use								not use							
Bit Map	D[16]	D[17]	D[18]	D[19]	D[20]	D[21]	D[22]	D[23]	D[24]	D[25]	D[26]	D[27]	D[28]	D[29]	D[30]	D[31]
item	×	×	×	×	×	×	×	×	×	×	×	×	×	×	×	×
Mapped Reg	not use								not use							
Bit Map	D[32]	D[33]	D[34]	D[35]	D[36]	D[37]	D[38]	D[39]	D[40]	D[41]	D[42]	D[43]	D[44]	D[45]	D[46]	D[47]
item	×	×	×	×	×	×	×	×	×	×	×	×	×	×	×	×
Mapped Reg	not use								not use							
Bit Map	D[48]	D[49]	D[50]	D[51]	D[52]	D[53]	D[54]	D[55]	D[56]	D[57]	D[58]	D[59]	D[60]	D[61]	D[62]	D[63]
item	×	×	×	×	×	×	×	E-Fuse Bit Replacement								
Mapped Reg	0x19								0x18							

Table.19E Bank E

Bit Map	E[0]	E[1]	E[2]	E[3]	E[4]	E[5]	E[6]	E[7]	E[8]	E[9]	E[10]	E[11]	E[12]	E[13]	E[14]	E[15]
item	I ² C Slave ID					Median Filter			×	×	×	×	×	×	×	×
Mapped Reg	0x27								not use							
Bit Map	E[16]	E[17]	E[18]	E[19]	E[20]	E[21]	E[22]	E[23]	E[24]	E[25]	E[26]	E[27]	E[28]	E[29]	E[30]	E[31]
item	×	×	×	×	×	×	×	×	×	×	×	×	Max Spot Size Threshold			
Mapped Reg	not use								0x24							
Bit Map	E[32]	E[33]	E[34]	E[35]	E[36]	E[37]	E[38]	E[39]	E[40]	E[41]	E[42]	E[43]	E[44]	E[45]	E[46]	E[47]
item	Max Spot Size Threshold					×	×	×	×	×	×	×	×	×	×	×
Mapped Reg	0x23								not use							
Bit Map	E[48]	E[49]	E[50]	E[51]	E[52]	E[53]	E[54]	E[55]	E[56]	E[57]	E[58]	E[59]	E[60]	E[61]	E[62]	E[63]
item	×	×	×	×	×	×	×	×	×	×	×	×	×	×	×	×
Mapped Reg	not use								not use							

×: not use or already done

Table.20 is shown the list of E-Fuse program flow.(Base on that program flow in Fig.40 and the bitmap in Table19)

Table.20 List of E-Fuse program flow and setting value

Stage	R/W		①	②	③	④	⑤	⑥
			Slave Address	Max. Pulse Width	Signal Accumulation	Median Filter	Cover Compensation	Max Spot Size
Stage1	W	address	0xEC					
		data	0xFF					
Stage2	W	address	0xC8					
		data(1st cycle)	0x00	0x10	0x13	0x05	0x33	0x1C
		data(2nd cycle)	-	-	-	-	0x3B	0x24
Stage3	W	address	0xC9					
		data(1st cycle)	0x45	0x21	0x11	0x15	0x73	0x75
		data(2nd cycle)	-	-	-	-	0x33	0x05
Stage4	W	address	0xCD					
		data(1st cycle)	Table.21	Table.22	Table.23	Table.24	*1	Table.25
		data(2nd cycle)	-	-	-	-	*2	0x00
Stage5	W	address	0xCA					
		data	0x01					
Stage6	W	address	0xCA					
		data	0x00					
Stage7	W	address1	0xEF					
		data1	0x00					
		address2	0xC8					
		data2	0x40					
		address3	0xC8					
Stage8	W	address	0xEE					
		data	0x06					
Stage9	W	address1	0xEF					
		data1	0x00					
		address2	0xEC					
		data2	0xFF					
		address3	0xEF					
Stage9	R	address1	0x27[4:0]	0x05[2:0]	0x05[4:3]	0x27[6:5]	0x10[7:0]	0x23[4:0]
		address2	-	-	-	-	0x11[7:3]	0x24[7:4]
Stage9	W	address4	0xEF					
		data4	0x00					
		address5	0xEC					
		data5	0x7F					

(1) I²C Slave Address

This product operates on I²C bus as slave device. This product has 16 kinds of address by programming upper 4 bits of slave address. Bank E is used in order to change slave address. E[3:0] is the bit for address assignment, and E[4] is an enable bit. Changed E[3:0] turns effective after E[4] is programmed to be 0.

Table.21 List of Slave ID

A7	A6	A5	A4	A3	A2	A1	A0	Slave ID		Notes
E[3]	E[2]	E[1]	E[0]	×	×	×	R/W	Write	Read	
0	0	0	0	0	0	0	※	0x00	0x01	
0	0	0	1	0	0	0	※	0x10	0x11	
0	0	1	0	0	0	0	※	0x20	0x21	
0	0	1	1	0	0	0	※	0x30	0x31	
0	1	0	0	0	0	0	※	0x40	0x41	
0	1	0	1	0	0	0	※	0x50	0x51	
0	1	1	0	0	0	0	※	0x60	0x61	
0	1	1	1	0	0	0	※	0x70	0x71	
1	0	0	0	0	0	0	※	0x80	0x81	Default
1	0	0	1	0	0	0	※	0x90	0x91	
1	0	1	0	0	0	0	※	0xA0	0xA1	
1	0	1	1	0	0	0	※	0xB0	0xB1	
1	1	0	0	0	0	0	※	0xC0	0xC1	
1	1	0	1	0	0	0	※	0xD0	0xD1	
1	1	1	0	0	0	0	※	0xE0	0xE1	
1	1	1	1	0	0	0	※	0xF0	0xF1	

※R/W Write : 0、Read : 1

Stage1, Stage5~Stage8

Please refer to flow chart in Fig.40 and Table.20

Stage2

Data 0x00 is set in Address 0xC8 because LSB of bit map is 0 (=E[0]).

Stage3

Data 0x45 is set in Address 0xC9 because programming bit number is 5(=E[4:0]) and bank value is 5(=Bank E).

Note) Data is defined as 0xmn, where m=bit number - 1 and n = bank value.

Stage4

Data 0x00 is set in Address 0xCD in case that Slave ID(write) is set to 0x00.

Data 0x10 is set in Address 0xCD in case that Slave ID(write) is set to 0x01.

Stage9

Programmed data in E-Fuse is checked whether it is correct or not by the following step.

step	Address	Data	R/W	Remark
1	0xEF	0x00	W	
2	0xEC	0xFF	W	
3	0xEF	0x03	W	
4	0x27	-	R	Check 0x27[4:0] = E[4:0] ?
5	0xEF	0x00	W	
6	0xEC	0x7F	W	

E-Fuse programming is done when 0x27[4:0] is equal to E[4:0]. If 0x27[4:0] is not equal to E[4:0], E-Fuse bit replacement should be executed because programming error occurs. (Refer to 12-5 E-Fuse bit replacement)

(2) Maximum Pulse Width of Emitting

GP2Y0E series have the function which adjust emitting power by detecting signal intensity. Emitting power is adjusted by control of emitting pulse width. Average current consumption decrease by restricting maximum emitting pulse width. However, distance characteristic change, especially distance output may become unstable in case of detecting reflector at far distance and with low reflectance because signal intensity is also decreased by restricting maximum emitting pulse width. In case that maximum pulse width of emitting is changed, there is the case that electro optical characteristic described in specification sheet is not satisfied. Please use it after confirming with customer's product. Table.22 value is the reference.

Table.22 Maximum Pulse Width of Emitting

A[18]	A[17]	A[16]	Max. Pulse Width	Average current	Note
1	1	1	Approx. 320us	26mA	Default
1	1	0	Approx. 240us	22mA	
1	0	1	Approx. 160us	18mA	
1	0	0	Approx. 80us	14mA	
0	1	1	Approx. 40us	12mA	

Stage1, Stage5~Stage8

Please refer to flow chart in Fig.40 and Table.20

Stage2

Data 0x10 is set in Address 0xC8 because LSB of bit map is 16 (=A[16]).

Stage3

Data 0x21 is set in Address 0xC9 because programming bit number is 3(=A[18:16]) and bank value is 1(=Bank A).

Stage4

Data 0x05 is set in Address 0xCD in case that maximum pulse width is set to 160us.

Data 0x03 is set in Address 0xCD in case that maximum pulse width is set to 40us.

Stage9

Programmed data in E-Fuse is checked whether it is correct or not by the following step.

step	Address	Data	R/W	Remark
1	0xEF	0x00	W	
2	0xEC	0xFF	W	
3	0xEF	0x03	W	
4	0x05	-	R	Check 0x05[2:0] = A[18:16] ?
5	0xEF	0x00	W	
6	0xEC	0x7F	W	

E-Fuse programming is done when 0x05[2:0] is equal to A[18:16]. If 0x05[2:0] is not equal to A[18:16], E-Fuse bit replacement should be executed because programming error occurs. (Refer to 12-5 E-Fuse bit replacement)

(3) Signal Accumulation

GP2Y0E series have the function which change the accumulation number of emitting signal. Signal intensity can be controlled by changing accumulation number. Response time is increased by increasing accumulation number, however stability of distance output is increased because signal intensity is also increased. In case that signal accumulation times are changed, there is the case that electro optical characteristic described in specification sheet is not satisfied. Please use it after confirming with customer's product. Response time in Table.23 is reference value.

Table.23 Signal Accumulation Number

A[20]	A[19]	Accumulation	Response Time	Note
0	0	1 time	20ms	
0	1	5 times	30ms	
1	0	30 times	80ms	
1	1	10 times	40ms	Default

Stage1, Stage5~Stage8

Please refer to flow chart in Fig.40 and Table.20

Stage2

Data 0x13 is set in Address 0xC8 because LSB of bit map is 19 (=A[19]).

Stage3

Data 0x11 is set in Address 0xC9 because programming bit number is 2(=A[20:19]) and bank value is 1(=Bank A).

Stage4

Data 0x00 is set in Address 0xCD in case that signal accumulation is set to 1 time.

Data 0x02 is set in Address 0xCD in case that signal accumulation is set to 30 times.

Stage9

Programmed data in E-Fuse is checked whether it is correct or not by the following step.

step	Address	Data	R/W	Remark
1	0xEF	0x00	W	
2	0xEC	0xFF	W	
3	0xEF	0x03	W	
4	0x05	-	R	Check 0x05[4:3] = A[20:19] ?
5	0xEF	0x00	W	
6	0xEC	0x7F	W	

E-Fuse programming is done when 0x05[4:3] is equal to A[20:19]. If 0x05[4:3] is not equal to A[20:19], E-Fuse bit replacement should be executed because programming error occurs. (Refer to 12-5 E-Fuse bit replacement)

(4) Median Filter

GP2Y0E series have the median calculation function by using several distance outputs in order to get output stable. Response time increases though distance output gets stable by using median calculation function. Median calculation number can be selected to 5, 7 or 9. That is, in case of 5, a median of 5 distance values is output after 5 times measurement. Reference value of response time by combination of accumulation and median filter is shown in Table.24. In case that median filter function is turned enable, there is the case that electro optical characteristic described in specification sheet becomes not to be satisfied. Please use it after confirming with customer's product.

Table.24 Median Filter

E[6]	E[5]	Data Number of Median	Response Time (Accumulation)				Note
			(1time)	(5times)	(10times)	(30times)	
0	0	7	30ms	90ms	160ms	430ms	
0	1	5	27ms	70ms	120ms	310ms	
1	0	9	35ms	110ms	200ms	550ms	
1	1	1	20ms	30ms	40ms	80ms	Default (10times)

Stage1, Stage5~Stage8

Please refer to flow chart in Fig.40 and Table.20

Stage2

Data 0x05 is set in Address 0xC8 because LSB of bit map is 5 (=E[5]).

Stage3

Data 0x15 is set in Address 0xC9 because programming bit number is 2(=E[6:5]) and bank value is 5(=Bank E).

Stage4

Data 0x00 is set in Address 0xCD in case that data number of median calculation is set to 7.

Data 0x02 is set in Address 0xCD in case that data number of median calculation is set to 9.

Stage9

Programmed data in E-Fuse is checked whether it is correct or not by the following step.

step	Address	Data	R/W	Remark
1	0xEF	0x00	W	
2	0xEC	0xFF	W	
3	0xEF	0x03	W	
4	0x27	-	R	Check 0x27[6:5] = E[6:5] ?
5	0xEF	0x00	W	
6	0xEC	0x7F	W	

E-Fuse programming is done when 0x27[6:5] is equal to E[6:5]. If 0x27[6:5] is not equal to E[6:5], E-Fuse bit replacement should be executed because programming error occurs. (Refer to 12-5 E-Fuse bit replacement)

(5) Cover Compensation

Compensation coefficient (k) is measured by the procedure and measurement environment as described in 11-5 cover compensation k is programmed in C[62:52], and C[51] is enable bit. Programmed C[62:52] turns enable by programming 0 in C[51]. There are total 12 bits in programming cover compensation coefficient. It is necessary 2 cycles shown in 12-3 Program Flow because they are over 8 bits. In case that k is programmed to 350, programmed data is C[62:51] = 0b001010111100 including enable bit C[51]. So, programmed data at 1st cycle in address 0xCD is 0xBC = 0b10111100 and programmed data at 2nd cycle in address 0xCD is 0x02 = 0b00000010.

1st cycle

Stage1, Stage5~Stage6

Please refer to flow chart in Fig.40 and Table.20

Stage2

Data 0x33 is set in Address 0xC8 because LSB of bit map is 51 (=C[51]).

Stage3

Data 0x73 is set in Address 0xC9 because programming bit number is 8(=C[58:51]) and bank value is 3(=Bank C).

Stage4

Data 0xBC is set in Address 0xCD in case cover compensation coefficient (k) is set to 350.

2nd cycle

Stage1, Stage5~Stage8

Please refer to flow chart in Fig.40 and Table.20

Stage2

Data 0x3B is set in Address 0xC8 because LSB of bit map is 59 (=C[59]).

Stage3

Data 0x33 is set in Address 0xC9 because programming bit number is 4(=C[62:59]) and bank value is 3(=Bank C).

Stage4

Data 0x02 is set in Address 0xCD in case that cover compensation coefficient (k) is set to 350.

Stage9

Programmed data in E-Fuse is checked whether it is correct or not by the following step.

step	Address	Data	R/W	Remark
1	0xEF	0x00	W	
2	0xEC	0xFF	W	
3	0xEF	0x03	W	
4	0x10	-	R	Check 0x10[7:0] = E[63:56] ?
5	0x11	-	R	Check 0x11[7:3] = E[55:51] ?
6	0xEF	0x00	W	
7	0xEC	0x7F	W	

E-Fuse programming is done when 0x10[7:0] is equal to E[63:56] and 0x11[7:3] is equal to E[55:51]. If 0x10[7:0] is not equal to E[63:56] and 0x11[7:3] is not equal to E[55:51], E-Fuse bit replacement should be executed because programming error occurs. (Refer to 12-5 E-Fuse bit replacement)

(6) Maximum Spot Size Threshold of Measurement Error Judgment

Maximum spot size threshold of GP2Y0E series can be set. There is the case that spot size of incomplete reflection such as the reflection from a fraction of emitting beam and the reflection from the reflective object with complex boundary line becomes large by deformed spot profile compared with spot size of normal reflection. It has high possibility that calculated distance by using this incomplete spot profile has large distance error. In order to prevent decrease of distance accuracy like this, the maximum threshold of spot size can be programmed in E-Fuse. This product outputs the calculated distance only in case spot size below threshold is detected. Table.25 shows a part of example of maximum spot size threshold setting. Maximum spot size threshold is set in E[35:28]. E[36] is an enable bit of this function. Programmed E[35:28] turns enable by changing E[36] to 0. There are total 9bits for maximum spot size threshold setting. It is necessary 2 cycles in 12-3 Program Flow because they are over 8bits. Measuring data of spot size can be read out by I²C bus. Please refer to register 0xF8 and 0xF9 (bank0) in register map.

Table.25 Maximum Spot Size Threshold

E[36]	E[35]	E[34]	E[33]	E[32]	E[31]	E[30]	E[29]	E[28]	Max. spot size threshold value
.	Specify threshold in E[35:28] E[36] is Enable Bit. Enable : E[36]=0, Disable : E[36]=1
0	0	1	0	1	0	0	0	0	80
0	0	1	0	1	0	0	0	1	81
0	0	1	0	1	0	0	1	0	82
0	0	1	0	1	0	0	1	1	83
.	
0	1	1	1	1	1	1	0	0	252
0	1	1	1	1	1	1	0	1	253
0	1	1	1	1	1	1	1	0	254
0	1	1	1	1	1	1	1	1	255

1st cycle

Stage1, Stage5~Stage6

Please refer to flow chart in Fig.40 and Table.20

Stage2

Data 0x1C is set in Address 0xC8 because LSB of bit map is 28 (=E[28]).

Stage3

Data 0x75 is set in Address 0xC9 because programming bit number is 8(=E[35:28]) and bank value is 5(=Bank E).

Stage4

Data 0x50 is set in Address 0xCD in case that maximum spot size threshold is set to 80.

Data 0x5A is set in Address 0xCD in case that maximum spot size threshold is set to 90.

2nd cycle

Stage1, Stage5~Stage8

Please refer to flow chart in Fig.40 and Table.20

Stage2

Data 0x24 is set in Address 0xC8 because LSB of bit map is 36 (=E[36]).

Stage3

Data 0x05 is set in Address 0xC9 because programming bit number is 1(=E[36]) and bank value is 5(=Bank E).

Stage4

Data 0x00 is set in Address 0xCD because enable bit is programmed to 0.

Stage9

Programmed data in E-Fuse is checked whether it is correct or not by the following step.

step	Address	Data	R/W	Remark
1	0xEF	0x00	W	
2	0xEC	0xFF	W	
3	0xEF	0x03	W	
4	0x23	-	R	Check 0x23[4:0] = E[36:32] ?
5	0x24	-	R	Check 0x24[7:4] = E[31:28] ?
6	0xEF	0x00	W	
7	0xEC	0x7F	W	

E-Fuse programming is done when 0x23[4:0] is equal to E[36:32] and 0x24[7:4] is equal to E[31:28]. If 0x23[4:0] is not equal to E[36:32] and 0x24[7:4] is not equal to E[31:28], E-Fuse bit replacement should be executed because programming error occurs. (Refer to 12-5 E-Fuse bit replacement)

12-5 E-Fuse Bit Replacement

There is the possibility that E-Fuse bit programmed fail (Fail rate is 20ppm/bit). Default value of each bit of E-Fuse is all "1", specified bit can be changed to "0" by executing program flow of Fig.37. If the bit cannot be programmed to "0" (always "1"), then this bit is fail bit. GP2Y0E series has the function that fail bit can be replaced. The bit number which can be replaced is one. If 2 bits are fail in this product, then this cannot be used.

(1) E-Fuse Bit Replacement Sequence

E-Fuse bit replacement is executed by specifying replace bit in D[63:55] of E-Fuse bit map. LSB of Bank A is "0", and MSB of Bank E is "319". Fail bit can be shown as 9bit number, the number is programmed in D[63:55] to replace it.

- The case of A[1] replacement
Programmed value in D[63:55] is "1". ($= 1+64*0 = 0x0001$, where 0 is the bank value of bank A)
- The case of C[51] replacement
Programmed value in D[63:55] is "179". ($= 51+64*2 = 0x00B3$, where 2 is the bank value of bank C)
- The case of E[4] replacement
Programmed value in D[63:55] is "260". ($= 4+64*4 = 0x0104$, where 4 is the bank value of bank E)

12-6 Example of E-Fuse Programming

The case where slave address is changed to 0x10(write) and 0x11(read) is shown in below concretely.

Stage1	Data=0xFF is set in Address=0xEC. 3.3V is applied in the Vpp terminal.
Stage2	Data=0x00 is set in Address=0xC8.
Stage3	Data=0x45 is set in Address=0xC9.
Stage4	Data=0x01 is set in Address=0xCD.
Stage5	Data=0x01 is set in Address=0xCA. Wait for 500us.
Stage6	Data=0x00 is set in Address=0xCA. Vpp terminal is grounded.
Stage7	Data=0x00 is set in Address=0xEF. Data=0x40 is set in Address=0xC8. Data=0x00 is set in Address=0xC8.
Stage8	Data=0x06 is set in Address=0xEE.
Stage9	Data=0xFF is set in Address=0xEC. Data=0x03 is set in Address=0xEF. Read out the data in Address=0x27. Data=0x00 is set in Address=0xEF. Data=0x7F is set in Address=0xEC.

When lower 5bits data[4:0] is 00001, E-Fuse program is finished.

When lower 5bits data[4:0] is not 00001, go to stage10(bit replacement).

Stage10 The case where the lower 5bits data is 10001 is assumed, and is shown in below flow.
When E[4] is replaced, Data=0x04 is programmed in D[55:62] in 1st cycle and Data=0x01 is programmed in D[63] in 2nd cycle because programmed value is 260(=0x0104).

Stage10-1 Data=0xFF is set in Address=0xEC.
3.3V is applied in Vpp terminal.

Stage10-2 Data=0x37 is set in Address=0xC8.

Stage10-3 Data=0x74 is set in Address=0xC9.

Stage10-4 Data=0x04 is set in Address=0xCD.

Stage10-5 Data=0x01 is set in Address=0xCA.
Wait for 500us.

Stage10-6 Data=0x00 is set in Address=0xCA.
Vpp terminal is grounded.

Stage10-1' Data=0xFF is set in Address=0xEC.
3.3V is applied in Vpp terminal.

Stage10-2' Data=0x3F is set in Address=0xC8.

Stage10-3' Data=0x04 is set in Address=0xC9.

Stage10-4' Data=0x01 is set in Address=0xCD.

Stage10-5' Data=0x01 is set in Address=0xCA.
Wait for 500us.

Stage10-6' Data=0x00 is set in Address=0xCA.
Vpp terminal is grounded.

Stage10-7 Data=0x00 is set in Address=0xEF.
Data=0x40 is set in Address=0xC8.
Data=0x00 is set in Address=0xC8.

Stage10-8 Data=0x06 is set in Address=0xEE.

Stage10-9 Data=0xFF is set in Address=0xEC.
Data=0x03 is set in Address=0xEF.
Read out the data in Address=0x18 and Address=0x19.

When Data=0x82 in the Address of 0x18 and Data=0 in the address of 0x19[7], program is finished.

When Data≠0x82 in the Address of 0x18 or Data≠0 in the address of 0x19[7], it is not possible to correct (=NG).