

High-Speed CMOS Logic 8-Bit Parallel-In/Serial-Out Shift Register

Features

- Buffered Inputs
- Asynchronous Parallel Load
- Complementary Outputs
- Fanout (Over Temperature Range)
 - Standard Outputs 10 LSTTL Loads
 - Bus Driver Outputs 15 LSTTL Loads
- Wide Operating Temperature Range . . . -55°C to 125°C
- Balanced Propagation Delay and Transition Times
- Significant Power Reduction Compared to LSTTL Logic ICs
- HC Types
 - 2V to 6V Operation
 - High Noise Immunity: $N_{IL} = 30\%$, $N_{IH} = 30\%$ of V_{CC} at $V_{CC} = 5V$
- HCT Types
 - 4.5V to 5.5V Operation
 - Direct LSTTL Input Logic Compatibility, $V_{IL} = 0.8V$ (Max), $V_{IH} = 2V$ (Min)
 - CMOS Input Compatibility, $I_I \leq 1\mu A$ at V_{OL} , V_{OH}

Description

The 'HC165 and 'HCT165 are 8-bit parallel or serial-in shift registers with complementary serial outputs (Q_7 and $\overline{Q_7}$) available from the last stage. When the parallel load (\overline{PL}) input is LOW, parallel data from the D0 to D7 inputs are loaded into the register asynchronously. When the \overline{PL} is HIGH, data enters the register serially at the DS input and shifts one place to the right ($Q_0 \rightarrow Q_1 \rightarrow Q_2$, etc.) with each positive-going clock transition. This feature allows parallel-to-serial converter expansion by tying the Q_7 output to the DS input of the succeeding device.

For predictable operation the LOW-to-HIGH transition of \overline{CE} should only take place while CP is HIGH. Also, CP and \overline{CE} should be LOW before the LOW-to-HIGH transition of PL to prevent shifting the data when \overline{PL} goes HIGH.

Ordering Information

PART NUMBER	TEMP. RANGE (°C)	PACKAGE
CD54HC165F3A	-55 to 125	16 Ld CERDIP
CD54HCT165F3A	-55 to 125	16 Ld CERDIP
CD74HC165E	-55 to 125	16 Ld PDIP
CD74HC165M	-55 to 125	16 Ld SOIC
CD74HC165MT	-55 to 125	16 Ld SOIC
CD54HC165M96	-55 to 125	16 Ld SOIC
CD74HCT165E	-55 to 125	16 Ld PDIP
CD74HCT165M	-55 to 125	16 Ld SOIC
CD74HCT165MT	-55 to 125	16 Ld SOIC
CD54HCT165M96	-55 to 125	16 Ld SOIC

NOTE: When ordering, use the entire part number. The suffix 96 denotes tape and reel. The suffix T denotes a small-quantity reel of 250.

Pinout

CD54HC165, CD54HCT165
(CERDIP)
CD74HC165, CD74HCT165
(PDIP, SOIC)
TOP VIEW

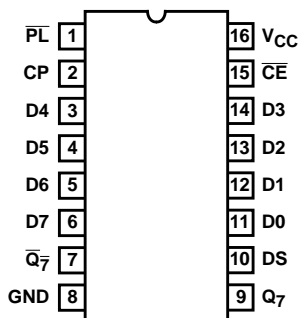

Functional Diagram

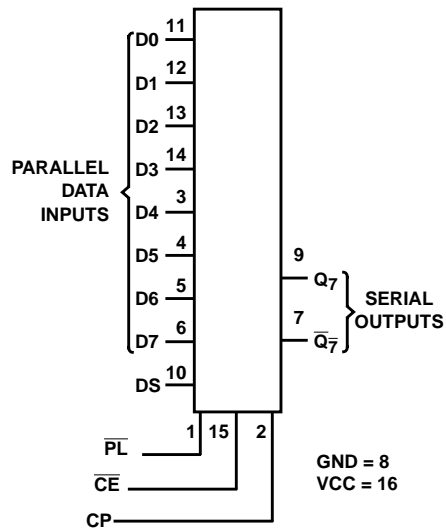

TRUTH TABLE

OPERATING MODE	INPUTS					Q _n REGISTER		OUTPUTS	
	\overline{PL}	\overline{CE}	CP	DS	D0 - D7	Q ₀	Q ₁ - Q ₆	Q ₇	$\overline{Q_7}$
Parallel Load	L	X	X	X	L	L	L-L	L	H
	L	X	X	X	H	H	H-H	H	L
Serial Shift	H	L	↑	l	X	L	q ₀ - q ₅	q ₆	$\overline{q_6}$
	H	L	↑	h	X	H	q ₀ - q ₅	q ₆	$\overline{q_6}$
Hold Do Nothing	H	H	X	X	X	q ₀	q ₁ - q ₆	q ₇	$\overline{q_7}$

H = High Voltage Level
 h = High Voltage Level One Set-up Time Prior To The Low-to-high Clock Transition
 l = Low Voltage Level One Set-up Time Prior To The Low-to-high Clock Transition
 L = Low Voltage Level
 X = Don't Care
 ↑ = Transition from Low to High Level
 q_n = Lower Case Letters Indicate The State Of the Reference Output Clock Transition

CD54HC165, CD74HC165, CD54HCT165, CD74HCT165

Absolute Maximum Ratings

DC Supply Voltage, V_{CC}	-0.5V to 7V
DC Input Diode Current, I_{IK}	
For $V_I < -0.5V$ or $V_I > V_{CC} + 0.5V$	$\pm 20mA$
DC Output Diode Current, I_{OK}	
For $V_O < -0.5V$ or $V_O > V_{CC} + 0.5V$	$\pm 20mA$
DC Drain Current per Output, I_O	
For $V_O < -0.5V$ $V_O > V_{CC} + 0.5V$	$\pm 25mA$
DC Output Source or Sink Current per Output Pin, I_O	
For $V_O > -0.5V$ or $V_O < V_{CC} + 0.5V$	$\pm 25mA$
DC V_{CC} or Ground Current, I_{CC} or I_{GND}	$\pm 50mA$

Thermal Information

Thermal Resistance (Typical, Note 1)	θ_{JA} (°C/W)
E (PDIP) Package	67
M (SOIC) Package	73
Maximum Junction Temperature	150°C
Maximum Storage Temperature Range	-65°C to 150°C
Maximum Lead Temperature (Soldering 10s)	300°C
(SOIC - Lead Tips Only)	

Operating Conditions

Temperature Range (T_A)	-55°C to 125°C
Supply Voltage Range, V_{CC}	
HC Types2V to 6V
HCT Types	4.5V to 5.5V
DC Input or Output Voltage, V_I , V_O	0V to V_{CC}
Input Rise and Fall Time	
2V	1000ns (Max)
4.5V	500ns (Max)
6V	400ns (Max)

CAUTION: Stresses above those listed in "Absolute Maximum Ratings" may cause permanent damage to the device. This is a stress only rating and operation of the device at these or any other conditions above those indicated in the operational sections of this specification is not implied.

NOTE:

- The package thermal impedance is calculated in accordance with JESD 51-7.

DC Electrical Specifications

PARAMETER	SYMBOL	TEST CONDITIONS		V_{CC} (V)	25°C			-40°C TO 85°C		-55°C TO 125°C		UNITS
		V_I (V)	I_O (mA)		MIN	TYP	MAX	MIN	MAX	MIN	MAX	
HC TYPES												
High Level Input Voltage	V_{IH}	-	-	2	1.5	-	-	1.5	-	1.5	-	V
				4.5	3.15	-	-	3.15	-	3.15	-	V
				6	4.2	-	-	4.2	-	4.2	-	V
Low Level Input Voltage	V_{IL}	-	-	2	-	-	0.5	-	0.5	-	0.5	V
				4.5	-	-	1.35	-	1.35	-	1.35	V
				6	-	-	1.8	-	1.8	-	1.8	V
High Level Output Voltage CMOS Loads	V_{OH}	V_{IH} or V_{IL}	-0.02	2	1.9	-	-	1.9	-	1.9	-	V
			-0.02	4.5	4.4	-	-	4.4	-	4.4	-	V
			-0.02	6	5.9	-	-	5.9	-	5.9	-	V
High Level Output Voltage TTL Loads	V_{OH}	V_{IH} or V_{IL}	-4	4.5	3.98	-	-	3.84	-	3.7	-	V
			-5.2	6	5.48	-	-	5.34	-	5.2	-	V
Low Level Output Voltage CMOS Loads	V_{OL}	V_{IH} or V_{IL}	0.02	2	-	-	0.1	-	0.1	-	0.1	V
			0.02	4.5	-	-	0.1	-	0.1	-	0.1	V
			0.02	6	-	-	0.1	-	0.1	-	0.1	V
Low Level Output Voltage TTL Loads	V_{OL}	V_{IH} or V_{IL}	4	4.5	-	-	0.26	-	0.33	-	0.4	V
			5.2	6	-	-	0.26	-	0.33	-	0.4	V
Input Leakage Current	I_I	V_{CC} or GND	-	6	-	-	± 0.1	-	± 1	-	± 1	μA

CD54HC165, CD74HC165, CD54HCT165, CD74HCT165

DC Electrical Specifications (Continued)

PARAMETER	SYMBOL	TEST CONDITIONS		V _{CC} (V)	25°C			-40°C TO 85°C		-55°C TO 125°C		UNITS
		V _I (V)	I _O (mA)		MIN	TYP	MAX	MIN	MAX	MIN	MAX	
Quiescent Device Current	I _{CC}	V _{CC} or GND	0	6	-	-	8	-	80	-	160	μA
HCT TYPES												
High Level Input Voltage	V _{IH}	-	-	4.5 to 5.5	2	-	-	2	-	2	-	V
Low Level Input Voltage	V _{IL}	-	-	4.5 to 5.5	-	-	0.8	-	0.8	-	0.8	V
High Level Output Voltage CMOS Loads	V _{OH}	V _{IH} or V _{IL}	-0.02	4.5	4.4	-	-	4.4	-	4.4	-	V
High Level Output Voltage TTL Loads			-4	4.5	3.98	-	-	3.84	-	3.7	-	V
Low Level Output Voltage CMOS Loads	V _{OL}	V _{IH} or V _{IL}	0.02	4.5	-	-	0.1	-	0.1	-	0.1	V
Low Level Output Voltage TTL Loads			4	4.5	-	-	0.26	-	0.33	-	0.4	V
Input Leakage Current	I _I	V _{CC} to GND	0	5.5	-	-	±0.1	-	±1	-	±1	μA
Quiescent Device Current	I _{CC}	V _{CC} or GND	0	5.5	-	-	8	-	80	-	160	μA
Additional Quiescent Device Current Per Input Pin: 1 Unit Load	ΔI _{CC} (Note 2)	V _{CC} -2.1	-	4.5 to 5.5	-	100	360	-	450	-	490	μA

NOTE:

- For dual-supply systems theoretical worst case (V_I = 2.4V, V_{CC} = 5.5V) specification is 1.8mA.

HCT Input Loading Table

INPUT	UNIT LOADS
DS, D0 to D7	0.35
CP, \overline{PL}	0.65

NOTE: Unit Load is ΔI_{CC} limit specified in DC Electrical Specifications table, e.g. 360μA max at 25°C.

Prerequisite For Switching Specifications

PARAMETER	SYMBOL	V _{CC} (V)	25°C		-40°C TO 85°C		-55°C TO 125°C		UNITS
			MIN	MAX	MIN	MAX	MIN	MAX	
HC TYPES									
CP Pulse Width	t _{WL} , t _{WH}	2	80	-	100	-	120	-	ns
		4.5	16	-	20	-	24	-	ns
		6	14	-	17	-	20	-	ns

CD54HC165, CD74HC165, CD54HCT165, CD74HCT165

Prerequisite For Switching Specifications (Continued)

PARAMETER	SYMBOL	V _{CC} (V)	25°C		-40°C TO 85°C		-55°C TO 125°C		UNITS
			MIN	MAX	MIN	MAX	MIN	MAX	
$\overline{\text{PL}}$ Pulse Width	t_{WL}	2	80	-	100	-	120	-	ns
		4.5	16	-	20	-	24	-	ns
		6	14	-	17	-	20	-	ns
Set-up Time DS to CP	t_{SU}	2	80	-	100	-	120	-	ns
		4.5	16	-	20	-	24	-	ns
		6	14	-	17	-	20	-	ns
$\overline{\text{CE}}$ to CP	$t_{\text{SU(L)}}$	2	80	-	100	-	120	-	ns
		4.5	16	-	20	-	24	-	ns
		6	14	-	17	-	20	-	ns
D0-D7 to $\overline{\text{PL}}$	t_{SU}	2	80	-	100	-	120	-	ns
		4.5	16	-	20	-	24	-	ns
		6	14	-	17	-	20	-	ns
Hold Time DS to CP or $\overline{\text{CE}}$	t_{H}	2	35	-	45	-	55	-	ns
		4.5	7	-	9	-	11	-	ns
		6	6	-	8	-	9	-	ns
$\overline{\text{CE}}$ to CP	t_{H}	2	0	-	0	-	0	-	ns
		4.5	0	-	0	-	0	-	ns
		6	0	-	0	-	0	-	ns
Recovery Time $\overline{\text{PL}}$ to CP	t_{REC}	2	100	-	125	-	150	-	ns
		4.5	20	-	25	-	30	-	ns
		6	17	-	21	-	26	-	ns
Maximum Clock Pulse Frequency	f_{MAX}	2	6	-	5	-	4	-	MHz
		4.5	30	-	24	-	20	-	MHz
		6	35	-	28	-	24	-	MHz

HCT TYPES

CP Pulse Width	$t_{\text{WL}}, t_{\text{WH}}$	4.5	18	-	23	-	27	-	ns
$\overline{\text{PL}}$ Pulse Width	t_{WL}	4.5	20	-	25	-	30	-	ns
Set-up Time DS to CP	t_{SU}	4.5	20	-	25	-	30	-	ns
$\overline{\text{CE}}$ to CP	$t_{\text{SU(L)}}$	4.5	20	-	25	-	30	-	ns
D0-D7 to $\overline{\text{PL}}$	t_{SU}	6	20	-	25	-	30	-	ns
Hold Time DS to CP or $\overline{\text{CE}}$	t_{H}	4.5	7	-	9	-	11	-	ns
$\overline{\text{CE}}$ to CP	$t_{\text{S}}, t_{\text{H}}$	4.5	0	-	0	-	0	-	ns
Recovery Time $\overline{\text{PL}}$ to CP	t_{REC}	4.5	20	-	25	-	30	-	ns
Maximum Clock Pulse Frequency	f_{MAX}	4.5	27	-	22	-	18	-	MHz

CD54HC165, CD74HC165, CD54HCT165, CD74HCT165

Switching Specifications Input $t_r, t_f = 6\text{ns}$

PARAMETER	SYMBOL	TEST CONDITIONS	V_{CC} (V)	25°C		-40°C TO 85°C	-55°C TO 125°C	UNITS
				TYP	MAX	MAX	MAX	
HC TYPES								
Propagation Delay CP or \overline{CE} to Q_7 or $\overline{Q_7}$	t_{PLH}, t_{PHL}	$C_L = 50\text{pF}$	2	-	165	205	250	ns
			4.5	-	33	41	50	ns
		$C_L = 15\text{pF}$	5	13	-	-	-	ns
		$C_L = 50\text{pF}$	6	-	28	35	43	ns
\overline{PL} to Q_7 or $\overline{Q_7}$	t_{PLH}, t_{PHL}	$C_L = 50\text{pF}$	2	-	175	220	265	ns
			4.5	-	35	44	53	ns
		$C_L = 15\text{pF}$	5	14	-	-	-	ns
		$C_L = 50\text{pF}$	6	-	30	37	45	ns
D7 to Q_7 or $\overline{Q_7}$	t_{PLH}, t_{PHL}	$C_L = 50\text{pF}$	2	-	150	190	225	ns
			4.5	-	30	38	45	ns
		$C_L = 15\text{pF}$	5	12	-	-	-	ns
		$C_L = 50\text{pF}$	6	-	26	33	38	ns
Output Transition Times	t_{TLH}, t_{THL}	$C_L = 50\text{pF}$	2	-	75	95	110	ns
			4.5	-	15	19	22	ns
			6	-	13	16	19	ns
Input Capacitance	C_{IN}	-	-	-	10	10	10	pF
Power Dissipation Capacitance (Notes 3, 4)	C_{PD}	-	5	17	-	-	-	pF
HCT TYPES								
Propagation Delay CP or \overline{CE} to Q_7 or $\overline{Q_7}$	t_{PLH}, t_{PHL}	$C_L = 50\text{pF}$	4.5	-	40	50	60	ns
		$C_L = 15\text{pF}$	5	17	-	-	-	ns
\overline{PL} to Q_7 or $\overline{Q_7}$	t_{PLH}, t_{PHL}	$C_L = 50\text{pF}$	4.5	-	40	50	60	ns
		$C_L = 15\text{pF}$	5	17	-	-	-	ns
D7 to Q_7 or $\overline{Q_7}$	t_{PLH}, t_{PHL}	$C_L = 50\text{pF}$	4.5	-	35	44	53	ns
		$C_L = 15\text{pF}$	5	14	-	-	-	ns
Output Transition Times	t_{TLH}, t_{THL}	$C_L = 50\text{pF}$	4.5	-	15	19	22	ns
Input Capacitance	C_{IN}	$C_L = 50\text{pF}$	-	-	10	10	10	pF
Power Dissipation Capacitance (Notes 3, 4)	C_{PD}	-	5	24	-	-	-	pF

NOTES:

- C_{PD} is used to determine the dynamic power consumption, per package.
- $P_D = V_{CC}^2 f_i + \sum (C_L V_{CC}^2 + f_o)$ where f_i = Input Frequency, f_o = Output Frequency, C_L = Output Load Capacitance, V_{CC} = Supply Voltage.

Test Circuits and Waveforms

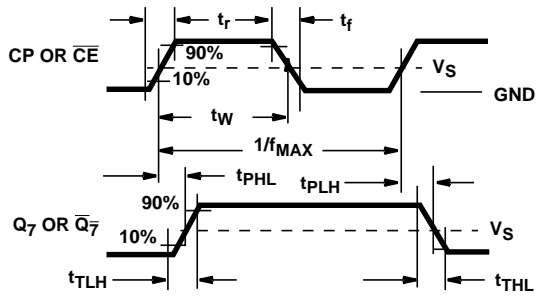

FIGURE 3. SERIAL-SHIFT MODE

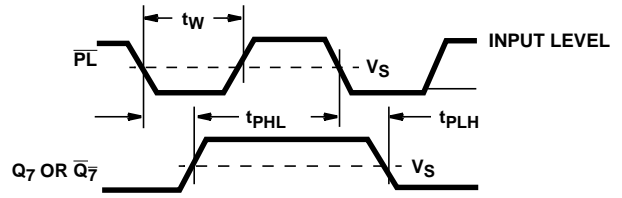

FIGURE 4. PARALLEL-LOAD MODE

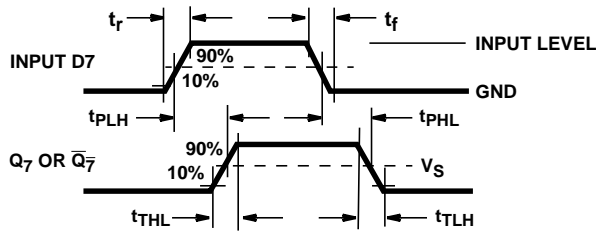

FIGURE 5. PARALLEL-LOAD MODE

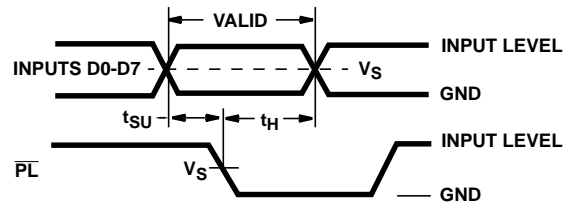

FIGURE 6. PARALLEL-LOAD MODE

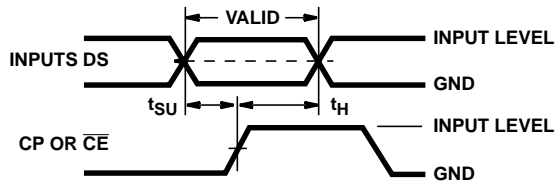

FIGURE 7. SERIAL-SHIFT MODE

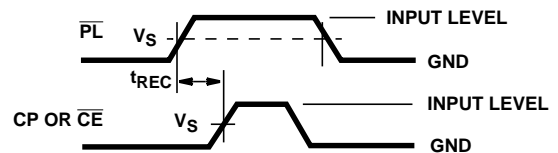

FIGURE 8. SERIAL-SHIFT MODE

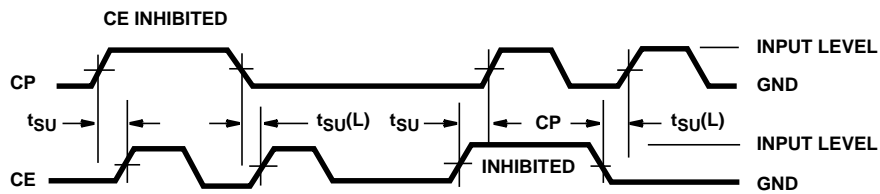

FIGURE 9. SERIAL-SHIFT, CLOCK-INHIBIT MODE

PACKAGING INFORMATION

Orderable Device	Status (1)	Package Type	Package Drawing	Pins	Package Qty	Eco Plan (2)	Lead/Ball Finish	MSL Peak Temp (3)	Op Temp (°C)	Top-Side Markings (4)	Samples
5962-8685501EA	ACTIVE	CDIP	J	16	1	TBD	Call TI	Call TI	-55 to 125	5962-8685501EA CD54HCT165F3A	Samples
CD54HC165F3A	ACTIVE	CDIP	J	16	1	TBD	A42	N / A for Pkg Type	-55 to 125	8409501EA CD54HC165F3A	Samples
CD54HCT165F3A	ACTIVE	CDIP	J	16	1	TBD	A42	N / A for Pkg Type	-55 to 125	5962-8685501EA CD54HCT165F3A	Samples
CD74HC165E	ACTIVE	PDIP	N	16	25	Pb-Free (RoHS)	CU NIPDAU	N / A for Pkg Type	-55 to 125	CD74HC165E	Samples
CD74HC165EE4	ACTIVE	PDIP	N	16	25	Pb-Free (RoHS)	CU NIPDAU	N / A for Pkg Type	-55 to 125	CD74HC165E	Samples
CD74HC165M	ACTIVE	SOIC	D	16	40	Green (RoHS & no Sb/Br)	CU NIPDAU	Level-1-260C-UNLIM	-55 to 125	HC165M	Samples
CD74HC165M96	ACTIVE	SOIC	D	16	2500	Green (RoHS & no Sb/Br)	CU NIPDAU	Level-1-260C-UNLIM	-55 to 125	HC165M	Samples
CD74HC165M96E4	ACTIVE	SOIC	D	16	2500	Green (RoHS & no Sb/Br)	CU NIPDAU	Level-1-260C-UNLIM	-55 to 125	HC165M	Samples
CD74HC165M96G4	ACTIVE	SOIC	D	16	2500	Green (RoHS & no Sb/Br)	CU NIPDAU	Level-1-260C-UNLIM	-55 to 125	HC165M	Samples
CD74HC165ME4	ACTIVE	SOIC	D	16	40	Green (RoHS & no Sb/Br)	CU NIPDAU	Level-1-260C-UNLIM	-55 to 125	HC165M	Samples
CD74HC165MG4	ACTIVE	SOIC	D	16	40	Green (RoHS & no Sb/Br)	CU NIPDAU	Level-1-260C-UNLIM	-55 to 125	HC165M	Samples
CD74HC165MT	ACTIVE	SOIC	D	16	250	Green (RoHS & no Sb/Br)	CU NIPDAU	Level-1-260C-UNLIM	-55 to 125	HC165M	Samples
CD74HC165MTE4	ACTIVE	SOIC	D	16	250	Green (RoHS & no Sb/Br)	CU NIPDAU	Level-1-260C-UNLIM	-55 to 125	HC165M	Samples
CD74HC165MTG4	ACTIVE	SOIC	D	16	250	Green (RoHS & no Sb/Br)	CU NIPDAU	Level-1-260C-UNLIM	-55 to 125	HC165M	Samples
CD74HCT165E	ACTIVE	PDIP	N	16	25	Pb-Free (RoHS)	CU NIPDAU	N / A for Pkg Type	-55 to 125	CD74HCT165E	Samples
CD74HCT165EE4	ACTIVE	PDIP	N	16	25	Pb-Free (RoHS)	CU NIPDAU	N / A for Pkg Type	-55 to 125	CD74HCT165E	Samples
CD74HCT165M	ACTIVE	SOIC	D	16	40	Green (RoHS & no Sb/Br)	CU NIPDAU	Level-1-260C-UNLIM	-55 to 125	HCT165M	Samples

Orderable Device	Status (1)	Package Type	Package Drawing	Pins	Package Qty	Eco Plan (2)	Lead/Ball Finish	MSL Peak Temp (3)	Op Temp (°C)	Top-Side Markings (4)	Samples
CD74HCT165M96	ACTIVE	SOIC	D	16	2500	Green (RoHS & no Sb/Br)	CU NIPDAU	Level-1-260C-UNLIM	-55 to 125	HCT165M	Samples
CD74HCT165M96E4	ACTIVE	SOIC	D	16	2500	Green (RoHS & no Sb/Br)	CU NIPDAU	Level-1-260C-UNLIM	-55 to 125	HCT165M	Samples
CD74HCT165M96G4	ACTIVE	SOIC	D	16	2500	Green (RoHS & no Sb/Br)	CU NIPDAU	Level-1-260C-UNLIM	-55 to 125	HCT165M	Samples
CD74HCT165ME4	ACTIVE	SOIC	D	16	40	Green (RoHS & no Sb/Br)	CU NIPDAU	Level-1-260C-UNLIM	-55 to 125	HCT165M	Samples
CD74HCT165MG4	ACTIVE	SOIC	D	16	40	Green (RoHS & no Sb/Br)	CU NIPDAU	Level-1-260C-UNLIM	-55 to 125	HCT165M	Samples
CD74HCT165MT	ACTIVE	SOIC	D	16	250	Green (RoHS & no Sb/Br)	CU NIPDAU	Level-1-260C-UNLIM	-55 to 125	HCT165M	Samples
CD74HCT165MTE4	ACTIVE	SOIC	D	16	250	Green (RoHS & no Sb/Br)	CU NIPDAU	Level-1-260C-UNLIM	-55 to 125	HCT165M	Samples
CD74HCT165MTG4	ACTIVE	SOIC	D	16	250	Green (RoHS & no Sb/Br)	CU NIPDAU	Level-1-260C-UNLIM	-55 to 125	HCT165M	Samples

(1) The marketing status values are defined as follows:

ACTIVE: Product device recommended for new designs.

LIFEBUY: TI has announced that the device will be discontinued, and a lifetime-buy period is in effect.

NRND: Not recommended for new designs. Device is in production to support existing customers, but TI does not recommend using this part in a new design.

PREVIEW: Device has been announced but is not in production. Samples may or may not be available.

OBSELETE: TI has discontinued the production of the device.

(2) Eco Plan - The planned eco-friendly classification: Pb-Free (RoHS), Pb-Free (RoHS Exempt), or Green (RoHS & no Sb/Br) - please check <http://www.ti.com/productcontent> for the latest availability information and additional product content details.

TBD: The Pb-Free/Green conversion plan has not been defined.

Pb-Free (RoHS): TI's terms "Lead-Free" or "Pb-Free" mean semiconductor products that are compatible with the current RoHS requirements for all 6 substances, including the requirement that lead not exceed 0.1% by weight in homogeneous materials. Where designed to be soldered at high temperatures, TI Pb-Free products are suitable for use in specified lead-free processes.

Pb-Free (RoHS Exempt): This component has a RoHS exemption for either 1) lead-based flip-chip solder bumps used between the die and package, or 2) lead-based die adhesive used between the die and leadframe. The component is otherwise considered Pb-Free (RoHS compatible) as defined above.

Green (RoHS & no Sb/Br): TI defines "Green" to mean Pb-Free (RoHS compatible), and free of Bromine (Br) and Antimony (Sb) based flame retardants (Br or Sb do not exceed 0.1% by weight in homogeneous material)

(3) MSL, Peak Temp. -- The Moisture Sensitivity Level rating according to the JEDEC industry standard classifications, and peak solder temperature.

(4) Only one of markings shown within the brackets will appear on the physical device.

Important Information and Disclaimer: The information provided on this page represents TI's knowledge and belief as of the date that it is provided. TI bases its knowledge and belief on information provided by third parties, and makes no representation or warranty as to the accuracy of such information. Efforts are underway to better integrate information from third parties. TI has taken and continues to take reasonable steps to provide representative and accurate information but may not have conducted destructive testing or chemical analysis on incoming materials and chemicals. TI and TI suppliers consider certain information to be proprietary, and thus CAS numbers and other limited information may not be available for release.

In no event shall TI's liability arising out of such information exceed the total purchase price of the TI part(s) at issue in this document sold by TI to Customer on an annual basis.

OTHER QUALIFIED VERSIONS OF CD54HC165, CD54HCT165, CD74HC165, CD74HCT165 :

- Catalog: [CD74HC165](#), [CD74HCT165](#)
- Military: [CD54HC165](#), [CD54HCT165](#)

NOTE: Qualified Version Definitions:

- Catalog - TI's standard catalog product
- Military - QML certified for Military and Defense Applications

TAPE AND REEL INFORMATION

QUADRANT ASSIGNMENTS FOR PIN 1 ORIENTATION IN TAPE

*All dimensions are nominal

Device	Package Type	Package Drawing	Pins	SPQ	Reel Diameter (mm)	Reel Width W1 (mm)	A0 (mm)	B0 (mm)	K0 (mm)	P1 (mm)	W (mm)	Pin1 Quadrant
CD74HC165M96	SOIC	D	16	2500	330.0	16.4	6.5	10.3	2.1	8.0	16.0	Q1
CD74HC165M96	SOIC	D	16	2500	330.0	16.4	6.5	10.3	2.1	8.0	16.0	Q1
CD74HCT165M96G4	SOIC	D	16	2500	330.0	16.4	6.5	10.3	2.1	8.0	16.0	Q1

TAPE AND REEL BOX DIMENSIONS

*All dimensions are nominal

Device	Package Type	Package Drawing	Pins	SPQ	Length (mm)	Width (mm)	Height (mm)
CD74HC165M96	SOIC	D	16	2500	367.0	367.0	38.0
CD74HC165M96	SOIC	D	16	2500	333.2	345.9	28.6
CD74HCT165M96G4	SOIC	D	16	2500	333.2	345.9	28.6

J (R-GDIP-T**)

14 LEADS SHOWN

CERAMIC DUAL IN-LINE PACKAGE



DIM \ PINS **	14	16	18	20
A	0.300 (7,62) BSC	0.300 (7,62) BSC	0.300 (7,62) BSC	0.300 (7,62) BSC
B MAX	0.785 (19,94)	.840 (21,34)	0.960 (24,38)	1.060 (26,92)
B MIN	—	—	—	—
C MAX	0.300 (7,62)	0.300 (7,62)	0.310 (7,87)	0.300 (7,62)
C MIN	0.245 (6,22)	0.245 (6,22)	0.220 (5,59)	0.245 (6,22)



4040083/F 03/03

- NOTES:
- All linear dimensions are in inches (millimeters).
 - This drawing is subject to change without notice.
 - This package is hermetically sealed with a ceramic lid using glass frit.
 - Index point is provided on cap for terminal identification only on press ceramic glass frit seal only.
 - Falls within MIL STD 1835 GDIP1-T14, GDIP1-T16, GDIP1-T18 and GDIP1-T20.

N (R-PDIP-T**)

PLASTIC DUAL-IN-LINE PACKAGE

16 PINS SHOWN



- NOTES:
- A. All linear dimensions are in inches (millimeters).
 - B. This drawing is subject to change without notice.
 - C. Falls within JEDEC MS-001, except 18 and 20 pin minimum body length (Dim A).
 - D. The 20 pin end lead shoulder width is a vendor option, either half or full width.

4040049/E 12/2002

D (R-PDSO-G16)

PLASTIC SMALL OUTLINE



- NOTES:
- A. All linear dimensions are in inches (millimeters).
 - B. This drawing is subject to change without notice.
 - C. Body length does not include mold flash, protrusions, or gate burrs. Mold flash, protrusions, or gate burrs shall not exceed 0.006 (0,15) each side.
 - D. Body width does not include interlead flash. Interlead flash shall not exceed 0.017 (0,43) each side.
 - E. Reference JEDEC MS-012 variation AC.

D (R-PDSO-G16)

PLASTIC SMALL OUTLINE



- NOTES:
- All linear dimensions are in millimeters.
 - This drawing is subject to change without notice.
 - Publication IPC-7351 is recommended for alternate designs.
 - Laser cutting apertures with trapezoidal walls and also rounding corners will offer better paste release. Customers should contact their board assembly site for stencil design recommendations. Refer to IPC-7525 for other stencil recommendations.
 - Customers should contact their board fabrication site for solder mask tolerances between and around signal pads.

IMPORTANT NOTICE

Texas Instruments Incorporated and its subsidiaries (TI) reserve the right to make corrections, enhancements, improvements and other changes to its semiconductor products and services per JESD46, latest issue, and to discontinue any product or service per JESD48, latest issue. Buyers should obtain the latest relevant information before placing orders and should verify that such information is current and complete. All semiconductor products (also referred to herein as "components") are sold subject to TI's terms and conditions of sale supplied at the time of order acknowledgment.

TI warrants performance of its components to the specifications applicable at the time of sale, in accordance with the warranty in TI's terms and conditions of sale of semiconductor products. Testing and other quality control techniques are used to the extent TI deems necessary to support this warranty. Except where mandated by applicable law, testing of all parameters of each component is not necessarily performed.

TI assumes no liability for applications assistance or the design of Buyers' products. Buyers are responsible for their products and applications using TI components. To minimize the risks associated with Buyers' products and applications, Buyers should provide adequate design and operating safeguards.

TI does not warrant or represent that any license, either express or implied, is granted under any patent right, copyright, mask work right, or other intellectual property right relating to any combination, machine, or process in which TI components or services are used. Information published by TI regarding third-party products or services does not constitute a license to use such products or services or a warranty or endorsement thereof. Use of such information may require a license from a third party under the patents or other intellectual property of the third party, or a license from TI under the patents or other intellectual property of TI.

Reproduction of significant portions of TI information in TI data books or data sheets is permissible only if reproduction is without alteration and is accompanied by all associated warranties, conditions, limitations, and notices. TI is not responsible or liable for such altered documentation. Information of third parties may be subject to additional restrictions.

Resale of TI components or services with statements different from or beyond the parameters stated by TI for that component or service voids all express and any implied warranties for the associated TI component or service and is an unfair and deceptive business practice. TI is not responsible or liable for any such statements.

Buyer acknowledges and agrees that it is solely responsible for compliance with all legal, regulatory and safety-related requirements concerning its products, and any use of TI components in its applications, notwithstanding any applications-related information or support that may be provided by TI. Buyer represents and agrees that it has all the necessary expertise to create and implement safeguards which anticipate dangerous consequences of failures, monitor failures and their consequences, lessen the likelihood of failures that might cause harm and take appropriate remedial actions. Buyer will fully indemnify TI and its representatives against any damages arising out of the use of any TI components in safety-critical applications.

In some cases, TI components may be promoted specifically to facilitate safety-related applications. With such components, TI's goal is to help enable customers to design and create their own end-product solutions that meet applicable functional safety standards and requirements. Nonetheless, such components are subject to these terms.

No TI components are authorized for use in FDA Class III (or similar life-critical medical equipment) unless authorized officers of the parties have executed a special agreement specifically governing such use.

Only those TI components which TI has specifically designated as military grade or "enhanced plastic" are designed and intended for use in military/aerospace applications or environments. Buyer acknowledges and agrees that any military or aerospace use of TI components which have **not** been so designated is solely at the Buyer's risk, and that Buyer is solely responsible for compliance with all legal and regulatory requirements in connection with such use.

TI has specifically designated certain components as meeting ISO/TS16949 requirements, mainly for automotive use. In any case of use of non-designated products, TI will not be responsible for any failure to meet ISO/TS16949.

Products

Audio	www.ti.com/audio
Amplifiers	amplifier.ti.com
Data Converters	dataconverter.ti.com
DLP® Products	www.dlp.com
DSP	dsp.ti.com
Clocks and Timers	www.ti.com/clocks
Interface	interface.ti.com
Logic	logic.ti.com
Power Mgmt	power.ti.com
Microcontrollers	microcontroller.ti.com
RFID	www.ti-rfid.com
OMAP Applications Processors	www.ti.com/omap
Wireless Connectivity	www.ti.com/wirelessconnectivity

Applications

Automotive and Transportation	www.ti.com/automotive
Communications and Telecom	www.ti.com/communications
Computers and Peripherals	www.ti.com/computers
Consumer Electronics	www.ti.com/consumer-apps
Energy and Lighting	www.ti.com/energy
Industrial	www.ti.com/industrial
Medical	www.ti.com/medical
Security	www.ti.com/security
Space, Avionics and Defense	www.ti.com/space-avionics-defense
Video and Imaging	www.ti.com/video

TI E2E Community

e2e.ti.com

Mouser Electronics

Authorized Distributor

Click to View Pricing, Inventory, Delivery & Lifecycle Information:

Texas Instruments:

[CD74HC165M](#) [CD74HC165E](#) [CD74HCT165M](#) [CD74HCT165E](#) [CD74HCT165M96](#) [CD74HCT165EE4](#)
[CD74HCT165M96E4](#) [CD74HCT165ME4](#) [CD74HCT165MT](#) [CD74HCT165MTE4](#) [CD74HC165M96G4](#)
[CD74HC165MG4](#) [CD74HC165MTG4](#) [CD74HC165EE4](#) [CD74HC165M96](#) [CD74HC165M96E4](#) [CD74HC165ME4](#)
[CD74HC165MT](#) [CD74HC165MTE4](#) [CD74HCT165M96G4](#) [CD74HCT165MG4](#) [CD74HCT165MTG4](#)