

## RECOMMENDATION ITU-R BT.709-3

**PARAMETER VALUES FOR THE HDTV STANDARDS FOR PRODUCTION  
AND INTERNATIONAL PROGRAMME EXCHANGE**

(Question ITU-R 27/11)

(1990-1994-1995-1998)

The ITU-R Radiocommunication Assembly,

*considering*

- a) that, already for many years, HDTV programs have been produced in several countries;
- b) that parameter values for HDTV production standards should have maximum commonality;
- c) that two scanning standards, 1125/60/2:1 and 1250/50/2:1, have been defined for that purpose, having a significant number of parameters which have been agreed on a worldwide basis;
- d) that the parameters defined for both systems meet the quality goals set for HDTV;
- e) that an active image format of 1920 pixels\* by 1080 lines provides square pixel sampling, with attendant advantages for interoperability between various applications including digital television and computer imagery;
- f) that high-quality conversion between those systems, as well as down-conversion to conventional television standards, has been successfully implemented;
- g) that programs produced and archived using those standards will not become obsolete on the advent of new digital production and distribution systems,

*recommends*

- 1** that for the production of HDTV programs and for international program exchange, one of the systems described in Parts I or II of this Recommendation, be used;
- 2** that for the new implementations, particularly where interoperability with other applications is important, systems described in Part II are preferred.

---

\* In the Recommendation, the term "pixel" is used to describe a picture element in the digital domain.

**SIGNAL PARAMETER VALUES FOR THE 1125/60/2:1  
SYSTEM AND THE 1250/50/2:1 SYSTEM**

**PART I – HDTV SYSTEMS RELATED TO CONVENTIONAL TELEVISION**

(The areas in bold characters in the tables below denote parameter values which have been agreed on a worldwide basis.)

**I.1 Opto-electronic conversion**

Item	Characteristics	
	Parameter	Value
		1125/60/2:1
<b>1.1</b>	<b>Opto-electronic transfer characteristics before non-linear precorrection</b>	<b>Assumed linear</b>
<b>1.2</b>	<b>Overall opto-electronic transfer characteristics at source</b>	$V = 1.099 L^{0.45} - 0.099$ for $1 \geq L \geq 0.018$ $V = 4.500 L$ for $0.018 > L \geq 0$ where: $L$ : luminance of the image $0 \leq L \leq 1$ $V$ : corresponding electrical signal
<b>1.3</b>	<b>Chromaticity coordinates (CIE, 1931)</b>	<b>Coordinates</b>
	<b>Primary</b>	$x$ $y$
	– <b>Red</b>	<b>0.640</b> <b>0.330</b>
	– <b>Green</b>	<b>0.300</b> <b>0.600</b>
	– <b>Blue</b>	<b>0.150</b> <b>0.060</b>
<b>1.4</b>	<b>Assumed chromaticity for equal primary signals</b>	<b><math>D_{65}</math></b>
	$E_R = E_G = E_B$	$x$ $y$
	<b>(Reference white)</b>	<b>0.3127</b> <b>0.3290</b>

**I.2 Picture characteristics**

Item	Characteristics	
	Parameter	Value
		1125/60/2:1
<b>2.1</b>	<b>Aspect ratio</b>	<b>16:9</b>
<b>2.2</b>	<b>Sample per active line</b>	<b>1920</b>
<b>2.3</b>	<b>Sampling lattice</b>	<b>Orthogonal</b>
<b>2.4</b>	Active lines per picture	1035                      1152

### I.3 Picture scanning characteristics

Item	Characteristics		
	Parameter	Value	
		1125/60/2:1	1250/50/2:1
3.1	Order of sample scanning	Left to right, top to bottom 1st line of field 1 above 1st line of field 2	
3.2	Interlace ratio	2:1	
3.3	Picture rate (Hz)	30	25
3.4	Total number of lines	1125	1250
3.5	Field frequency (Hz)	60	50
3.6	Line frequency (Hz)	33 750 ± 0.001%	31 250 ± 0.0001%

### I.4 Signal format

The terms  $R$ ,  $G$ ,  $B$ ,  $Y$ ,  $C_B$ ,  $C_R$ , are often used and are generally understood to refer to the signals  $E'_R$ ,  $E'_G$ ,  $E'_B$ ,  $E'_Y$ ,  $E'_{C_B}$ ,  $E'_{C_R}$ , respectively (i.e. they correspond to gamma pre-corrected signals).

Item	Characteristics		
	Parameter	Value	
		1125/60/2:1	1250/50/2:1
4.1	Conceptual non-linear pre-correction of primary signals	$\gamma = 0.45$ (see § 1.2)	
4.2	Derivation of luminance signal $E'_Y$ <sup>(1)</sup>	$E'_Y = 0.2126 E'_R + 0.7152 E'_G + 0.0722 E'_B$	$E'_Y = 0.299 E'_R + 0.587 E'_G + 0.114 E'_B$
4.3	Derivation of colour-difference signal (analogue coding) <sup>(1)</sup>	$E'_{C_B} = 0.5389 (E'_B - E'_Y)$ $E'_{C_R} = 0.6350 (E'_R - E'_Y)$	$E'_{C_B} = 0.564 (E'_B - E'_Y)$ $E'_{C_R} = 0.713 (E'_R - E'_Y)$
4.4	Derivation of colour-difference signal (digital coding) $C_B$ , $C_R$	Digitally scaled from the values of item 4.3	

(1) The coefficients for the equations have been calculated following the rules laid down in SMPTE RP177-1993.

## I.5 Analogue representation

Levels are specified in millivolts (mV) measured across a matched 75  $\Omega$  termination.

Item	Characteristics		
	Parameter	Value	
		1125/60/2:1	1250/50/2:1
5.1	Nominal level (mV) $E'_R, E'_G, E'_B, E'_Y$	Reference black: 0 Reference white: 700 (see Fig. 1)	
5.2	Nominal level (mV) $E'_{C_B}, E'_{C_R}$	$\pm 350$ (see Fig. 1)	
5.3	Form of synchronizing signal	Tri-level bipolar (see Fig. 2)	
5.4	Line sync timing reference	OH (see Fig. 2)	
5.5	Sync level (mV)	$\pm 300 \pm 2\%$	
5.6	Sync signal timing	(See Table 1 and Fig. 3) Sync on all components	(See Fig. 4) – rise time 50 $\pm$ 10 ns (between 10%-90%) – see also <sup>(1)</sup>
5.7	Inter-component timing accuracy	Not applicable	$\pm 2$ ns
5.8	Blanking interval	(See Table 1 and Fig. 5)	(See Tables 2 and 3)
5.9	Nominal signal bandwidth (MHz)	30 (for all components)	

- (1) When using  $R, G, B$  signals, the use of syncs on at least the green channel is advised; transmission of separate syncs is also acceptable. When using  $Y, C_B, C_R$  signals the  $Y$  signal at least carries sync.

FIGURE 1  
Sync level on component signals

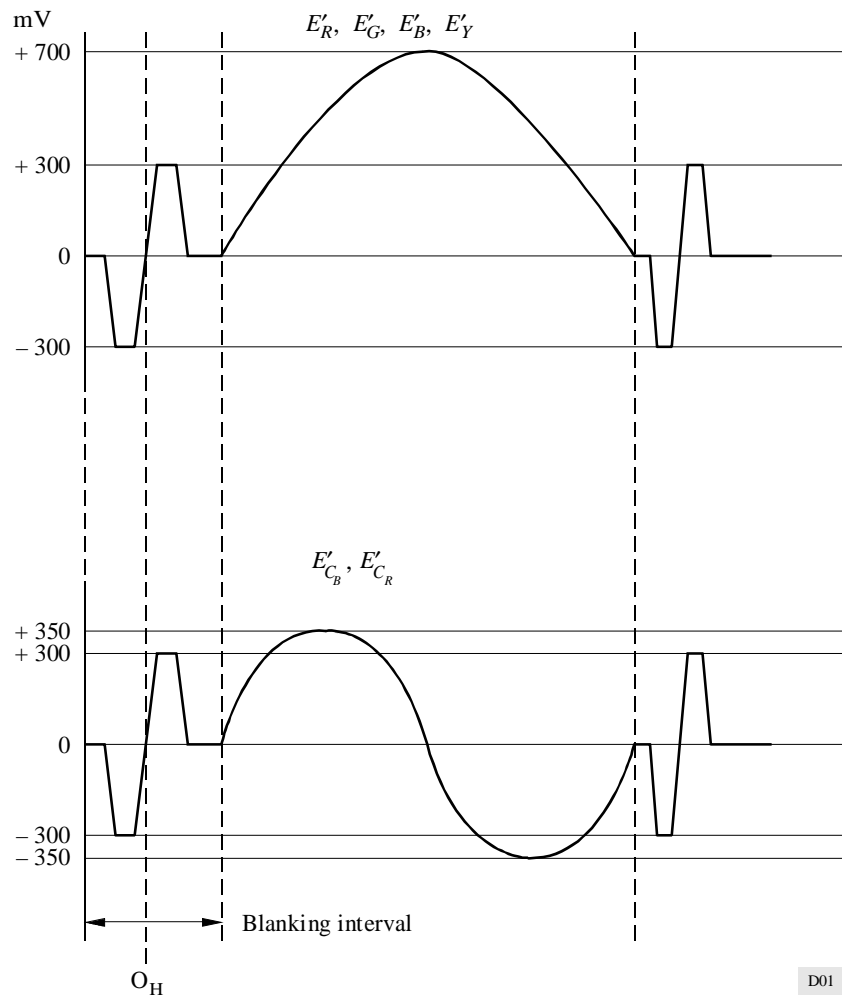
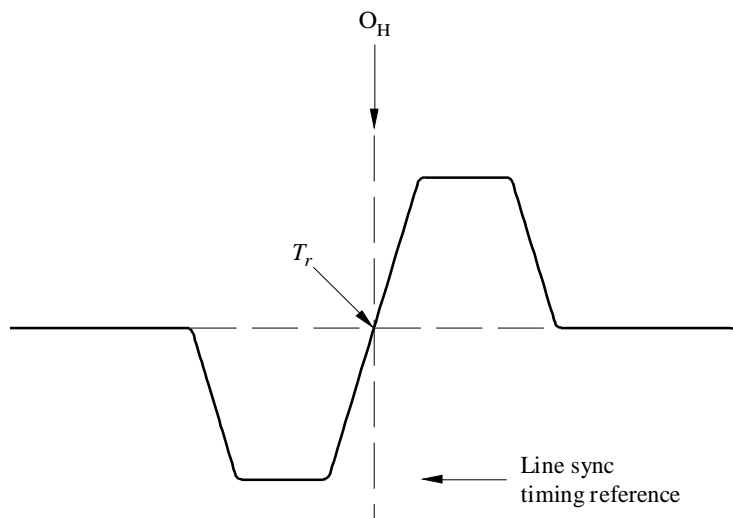

FIGURE 2  
Form of synchronizing signal



(The waveform exhibits symmetry with respect to point  $T_r$ )

D02

FIGURE 3  
Line synchronizing signal waveform for the 1125/60/2:1 system

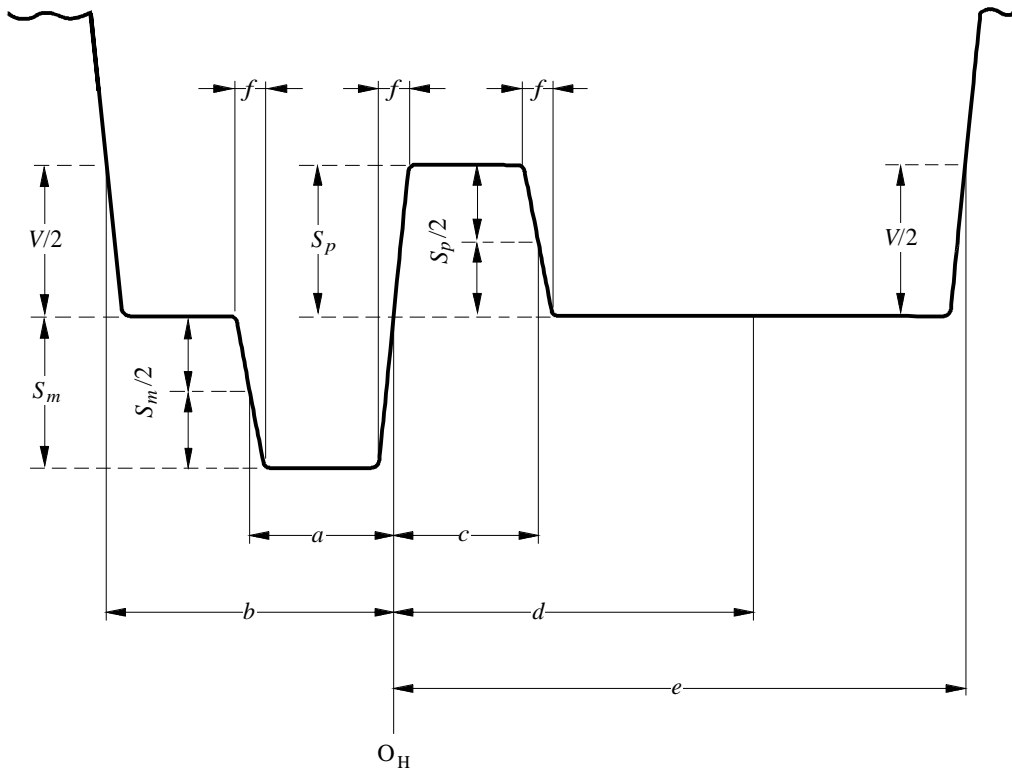

Line sync timing references

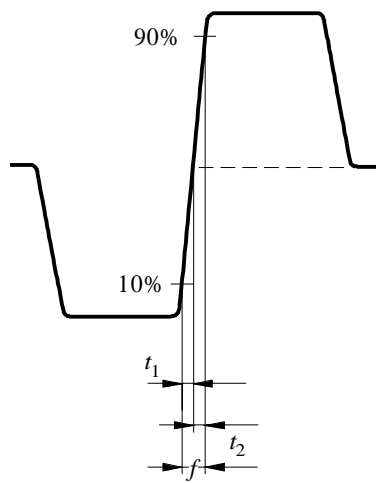

TABLE 1  
**Level and timing specification of synchronizing signal of the 1125/60/2:1 system**  
 (see Figs. 3 and 5)

Symbol	Parameter	Nominal value	Reference clock intervals	Tolerance
<i>a</i>	Negative line sync width	0.593 $\mu$ s	44	$\pm 0.040 \mu$ s
<i>b</i>	End of active video	1.185 $\mu$ s	88	+0.080 $\mu$ s/- 0 $\mu$ s
<i>c</i>	Positive line sync width	0.593 $\mu$ s	44	$\pm 0.040 \mu$ s
<i>d</i>	Clamp period	1.778 $\mu$ s	132	$\pm 0.040 \mu$ s
<i>e</i>	Start of active video	2.586 $\mu$ s	192	+0.080 $\mu$ s/- 0 $\mu$ s
<i>f</i>	Rise/fall time	0.054 $\mu$ s	4	$\pm 0.020 \mu$ s
<i>t<sub>2</sub>-t<sub>1</sub></i>	Symmetry of rising edge	-	-	$\pm 0.002 \mu$ s
<i>S<sub>m</sub></i>	Amplitude of negative pulse	300 mV	-	$\pm 6$ mV
<i>S<sub>p</sub></i>	Amplitude of positive pulse	300 mV	-	$\pm 6$ mV
<i>V</i>	Amplitude of video signal	700 mV	-	-
-	Field-blanking interval	45 <i>H</i> /field	99 000	-

FIGURE 4  
**Line synchronizing signal waveform for the 1250/50/2:1 system**

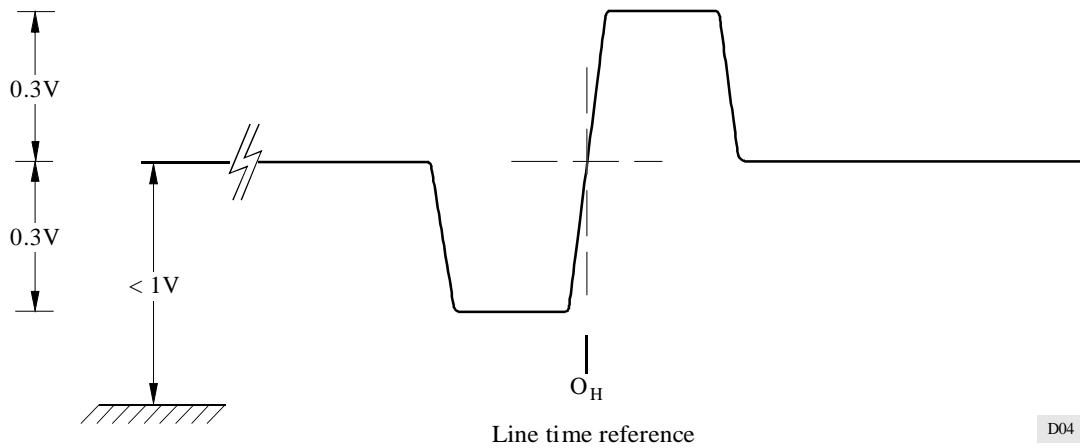
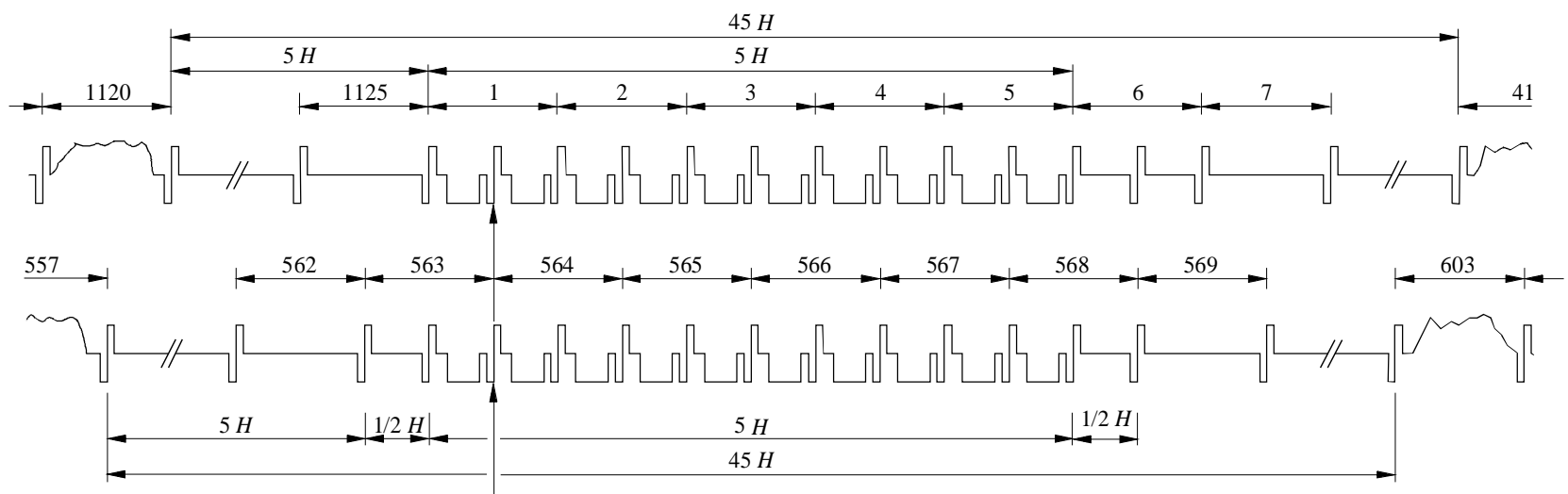
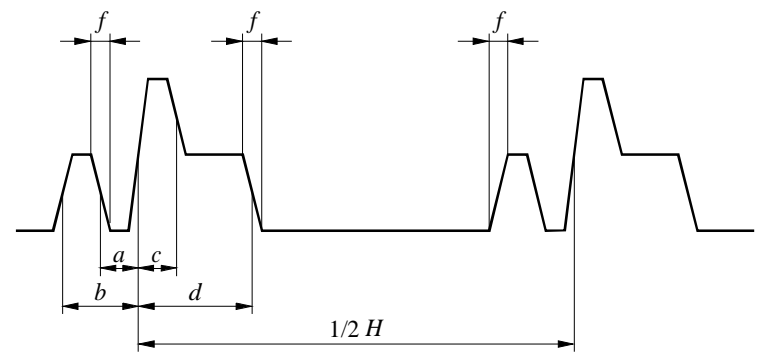

FIGURE 5  
Field synchronizing signal waveform for the 1125/60/2:1 system



Field sync timing reference



D05



TABLE 2

**Line timing details for the 1250/50/2:1 system**  
(see Figs. 4, 6 and 7)

Item	Parameter	Time (µs)	2.25 MHz samples	72 MHz samples
1	Total line length	32	72	2 304
2	Active line length <sup>(1)</sup> – digital – analogue	26.67 26.00	60 (58.5)	1 920 1 872
3	Line blanking <sup>(2)</sup> – digital – analogue	5.33 6.00	12 (13.5)	384 432
4	Front porch <sup>(2)</sup>	0.89	2	64
5	Back porch <sup>(2)</sup>	2.67	6	192
6	Tri-level sync half width (T-sync)	0.89	2	64
7	Field pulse	8.00	18	576

- (1) Relative disposition of analogue and digital active lines assumed to be as per scaled version of Recommendation ITU-R BT.601 (Part A) (i.e. symmetrical). Analogue active line measured from the half-height of signal after line blanking. Rise and fall times assumed to be 15 ns but subject to ratification. Analogue blanking should preferably be applied at the studio or playout output.
- (2) Front porch is defined at the interval between the end of active video and the half-height of the leading negative edge of the tri-level sync pulse. Similarly back porch is the interval between the half-height of the trailing negative edge of the tri-level sync and the start of active video (see Fig. 6).

TABLE 3

**Field timing details for the 1250/50/2:1 system**  
(see Figs. 7 and 8)

Item	Parameter	Value/Description
1	Total number of lines per frame	1 250
2	Total number of lines per field	625
3	Active lines per frame	1 152
4	Active lines per field	576
5	Frame reference OV	OH on line 1
6	Frame indication	Line 1 250
7	Field indication	Line 625
8	Active lines field 1	Lines 45 ... 620 inclusive
9	Active lines field 2	Lines 670 ... 1 245 inclusive
10	Field blanking	Lines 1 246 ... 44 and 621 ... 669 inclusive

FIGURE 6  
Line sync timing references for the 1250/50/2:1 system  
after D/A conversion and before final analogue blanking

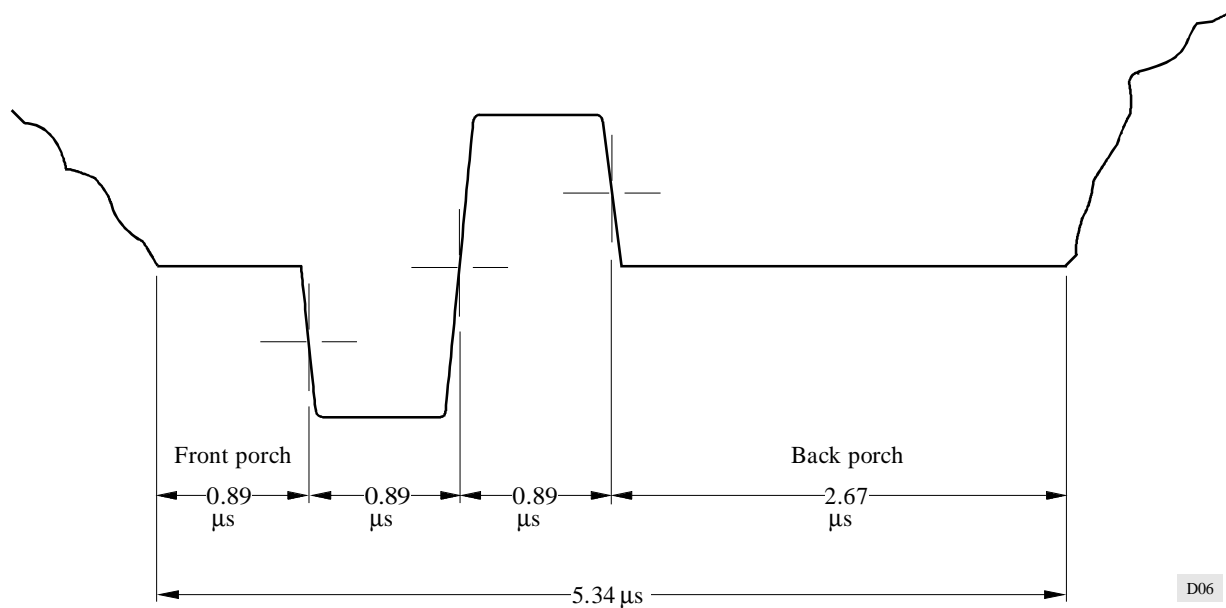

D06

FIGURE 7  
Frame and field identification for the 1250/50/2:1 system

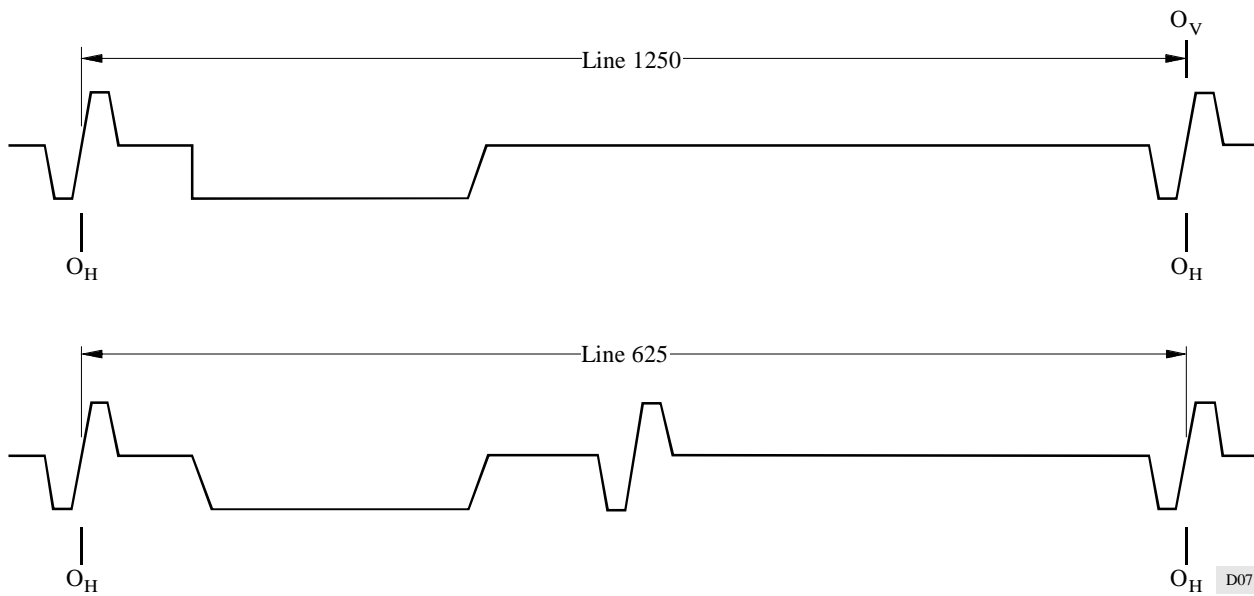

D07

FIGURE 8  
 Timing of signals during the field-blanking interval  
 for the 1250/50/2:1 system

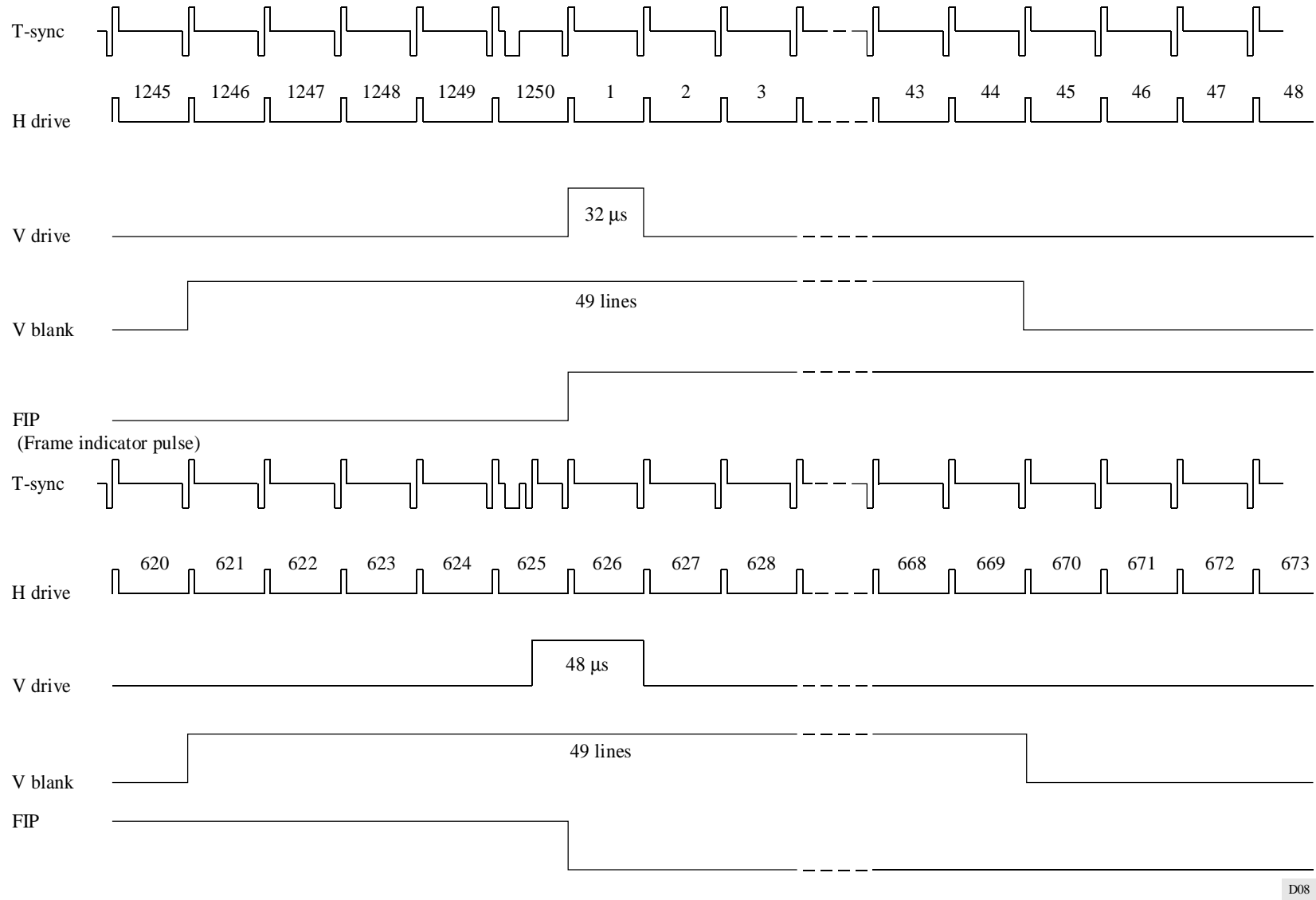

## I.6 Digital representation

Item	Parameter	Characteristics	
		Value	
		1125/60/2:1	1250/50/2:1
6.1	Coded signal	<i>R, G, B, or Y, C<sub>B</sub>, C<sub>R</sub></i>	
6.2	Sampling lattice – <i>R, G, B, Y</i>	Orthogonal, line and picture repetitive	
6.3	Sampling lattice signal – <i>C<sub>B</sub>, C<sub>R</sub></i>	Orthogonal, line and picture repetitive co-sited with each other and with alternate <sup>(1)</sup> <i>Y</i> samples	
6.4	Sampling frequency (MHz) – <i>R, G, B, Y</i>	(Multiples of 2.25 MHz)	
		74.25 ± 0.001% (33 × 2.25)	72 ± 0.0001% (32 × 2.25)
6.5	Sampling frequency (MHz) – <i>C<sub>B</sub>, C<sub>R</sub></i>	(Half of luminance sampling frequency)	
		37.125 ± 0.001% (33/2 × 2.25)	36 ± 0.0001% (32/2 × 2.25)
6.6	Number of samples per full line – <i>R, G, B, Y</i> – <i>C<sub>B</sub>, C<sub>R</sub></i>	2200	2304
		1100	1152
6.7	Active number of samples per line – <i>R, G, B, Y</i> – <i>C<sub>B</sub>, C<sub>R</sub></i>	1920 960	
6.8	Coding format	Linear, 8 or 10 bit/component	
6.9	Timing relationship between the analogue synchronizing reference O <sub>H</sub> and video data (in clock periods)	192	256
6.10	Quantization levels <sup>(2)</sup> – Black level <i>R, G, B, Y</i> – Achromatic <i>C<sub>B</sub>, C<sub>R</sub></i> – Nominal peak – <i>R, G, B, Y</i> – <i>C<sub>B</sub>, C<sub>R</sub></i>	8 bit coding 16 128 235 16 and 240	
6.11	Quantization level assignment <sup>(3)</sup> – Video data – Timing references <sup>(2)</sup>	8 bit coding 1 through 254 0 and 255	
6.12	Filter characteristics <sup>(4)</sup> – <i>R, G, B, Y</i> – <i>C<sub>B</sub>, C<sub>R</sub></i>	See Fig. 9A See Fig. 9B	See Fig. 10A See Fig. 10B

(1) The first active colour-difference samples being co-sited with the first active luminance sample.

(2) For 1125/60/2:1 – In the case of 10 bit representation the two LSBs are ignored.

(3) For 1125/60/2:1 – For 10 bit coding two LSBs are added to the 8 bit code words.  
For 1250/50/2:1 – 10 bit representation is under study.

(4) These filter templates are defined as guidelines.

FIGURE 9A  
 Filter characteristics for *R*, *G*, *B* and *Y* signals  
 for the 1125/60/2:1 system

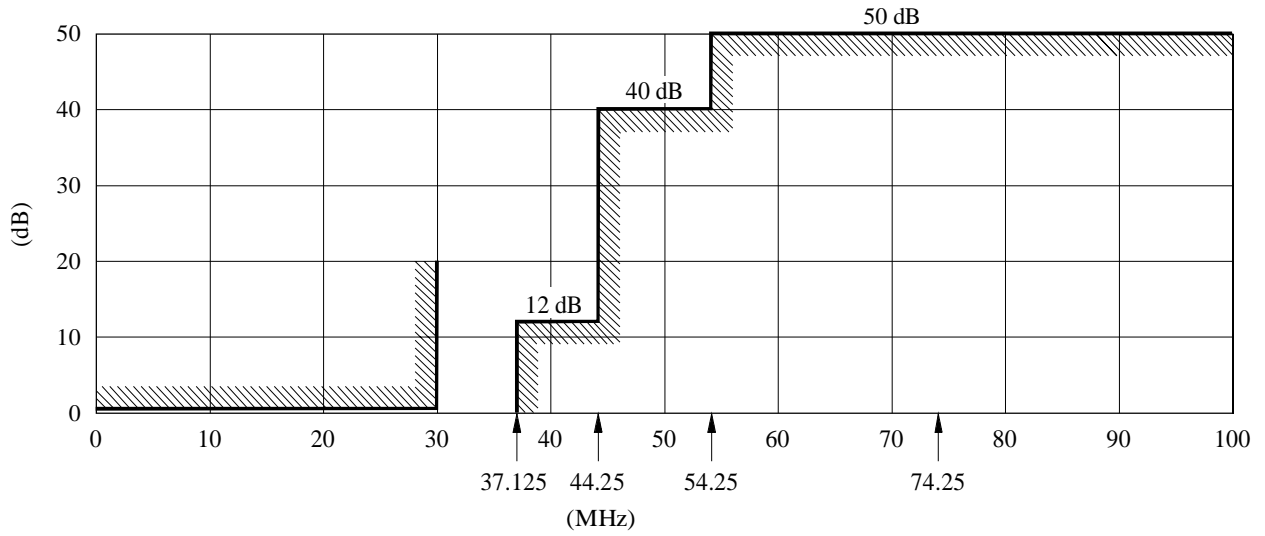

a) Template for insertion loss/frequency characteristic

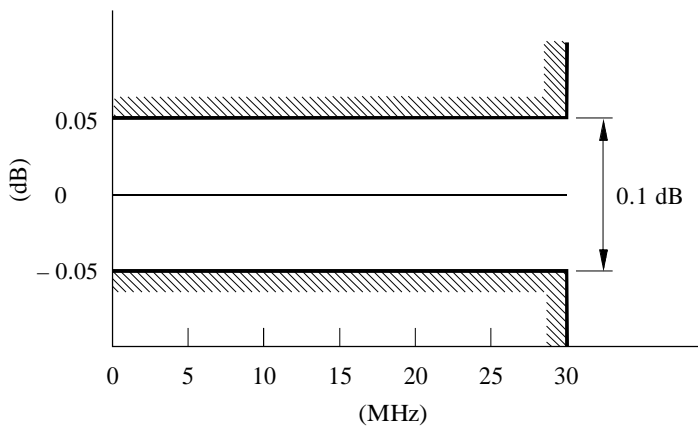

b) Passband ripple tolerance

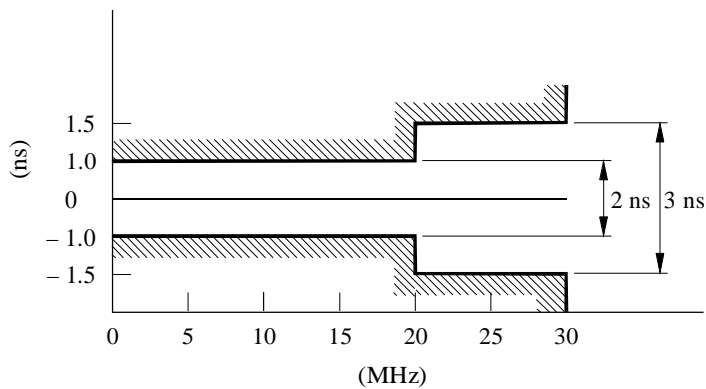

c) Passband group-delay tolerance

Note 1 – The lowest frequency value in b) and c) is 100 kHz (instead of 0 MHz).

FIGURE 9B  
 Filter characteristics for  $C_B$  and  $C_R$  signals  
 for the 1125/60/2:1 system

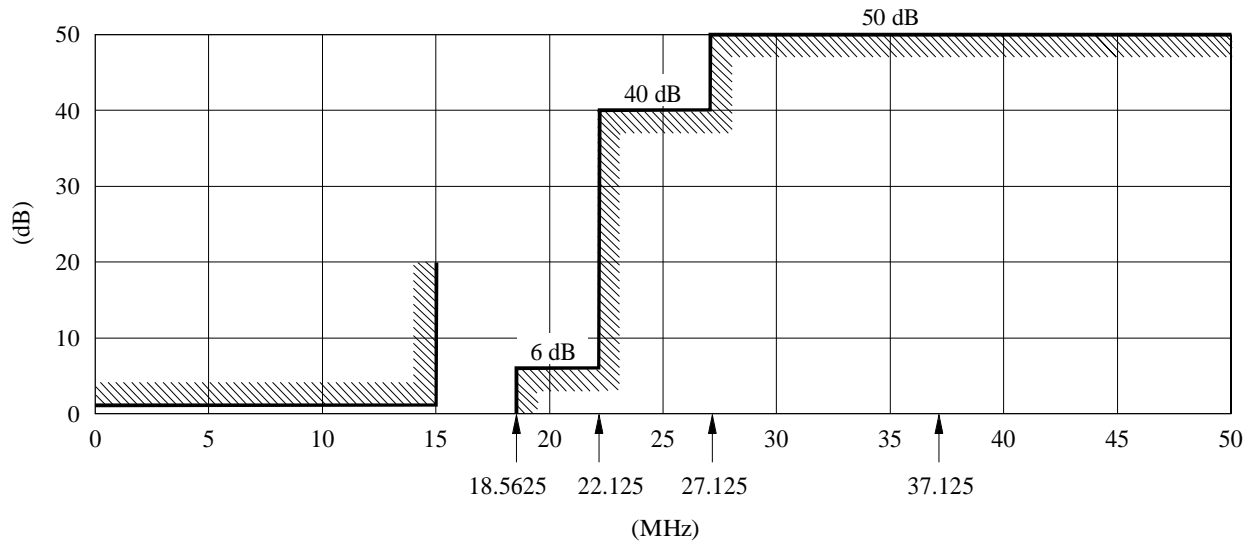

a) Template for insertion loss/frequency characteristic

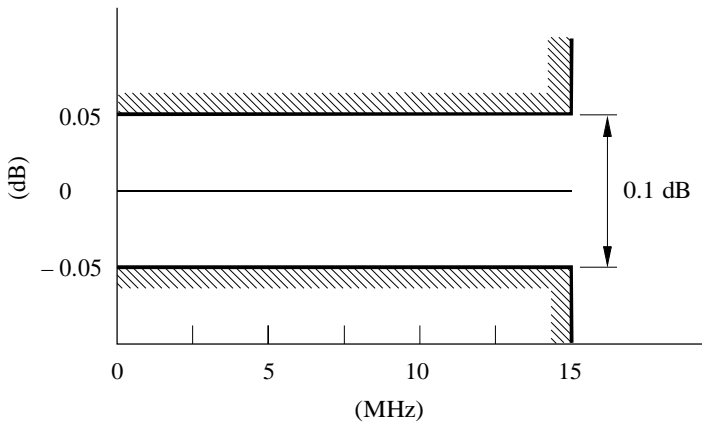

b) Passband ripple tolerance

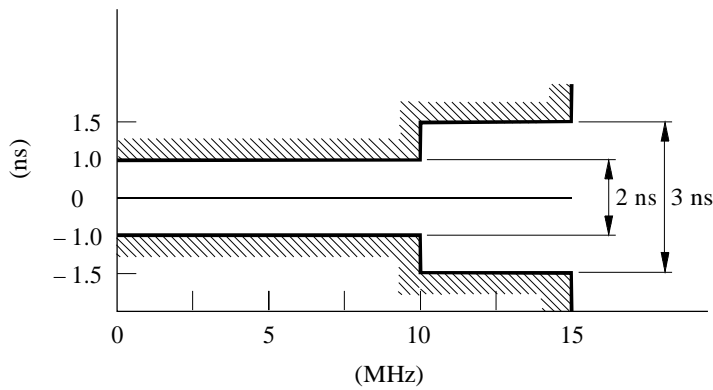

c) Passband group-delay tolerance

Note 1 – The lowest frequency value in b) and c) is 100 kHz (instead of 0 MHz).

FIGURE 10A  
Filter characteristics for R, G, B and Y signals  
for the 1250/50/2:1 system

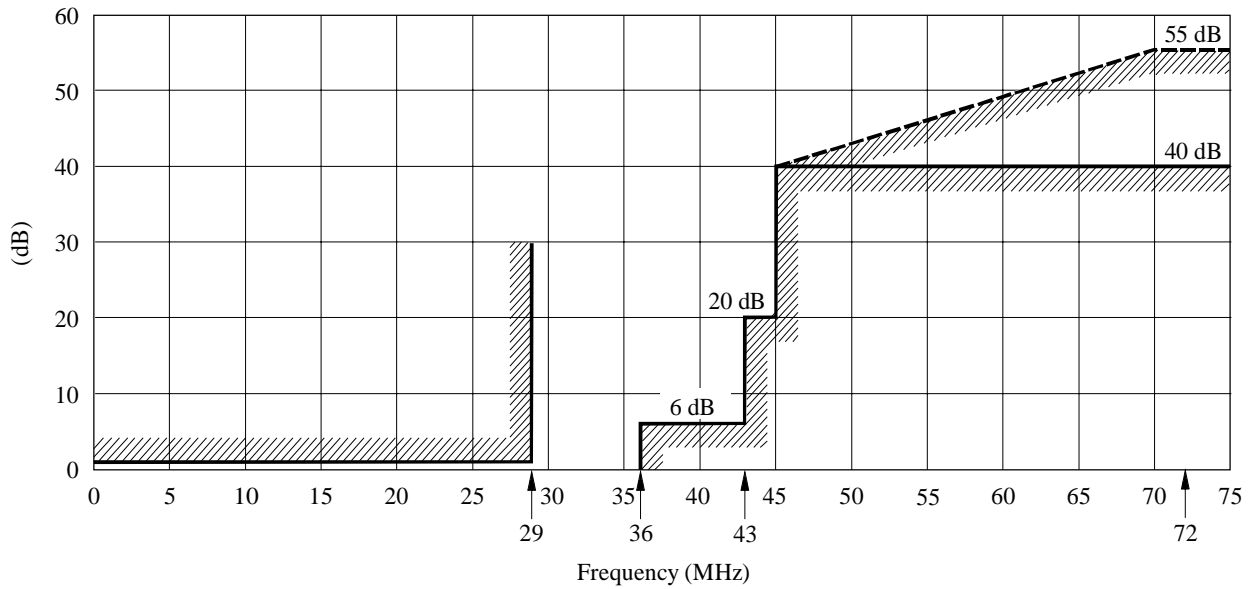

a) Template for insertion loss/frequency characteristic

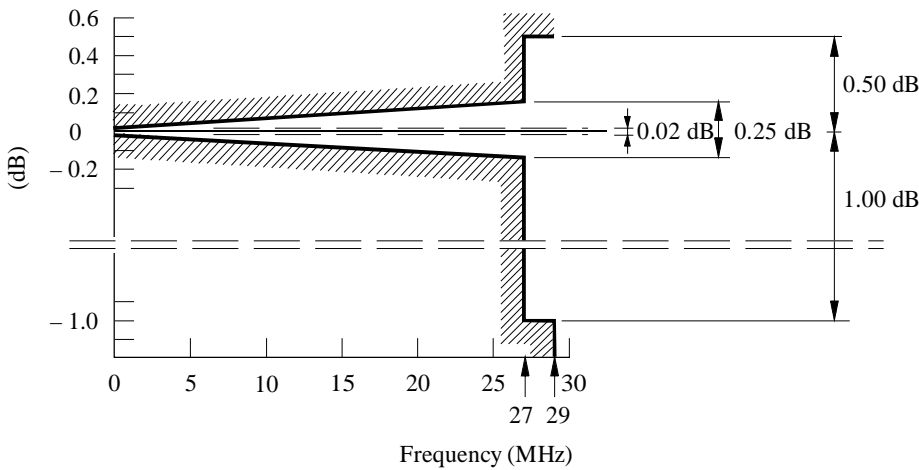

b) Passband ripple tolerance

*Note 1* – In a digital implementation:

- the insertion loss should be at least 55 dB above 70 MHz (dashed-line template);
- the amplitude/frequency characteristic (on linear scales) should be skew-symmetric about the nail amplitude point;
- the group delay distortion should be zero by design.

*Note 2* – Ripple and group delay are specified relative to their values at 5 kHz.

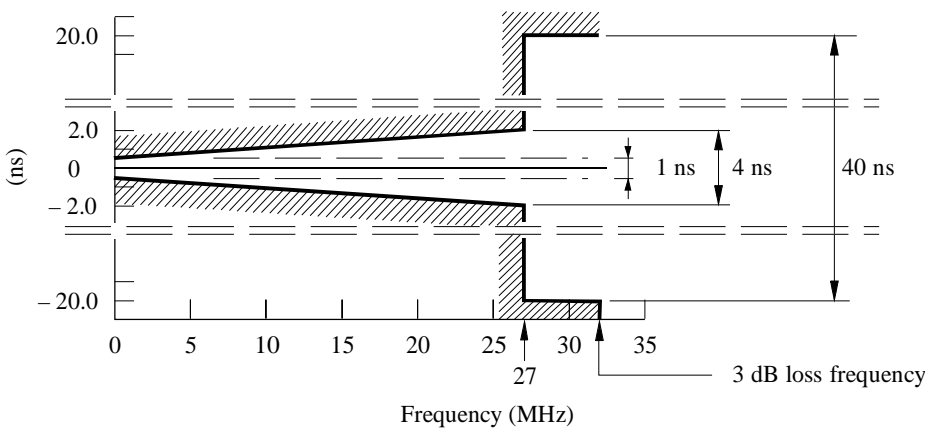

c) Passband group-delay tolerance

FIGURE 10B  
Filter characteristics for  $C_B$  and  $C_R$  signals  
for the 1250/50/2:1 system

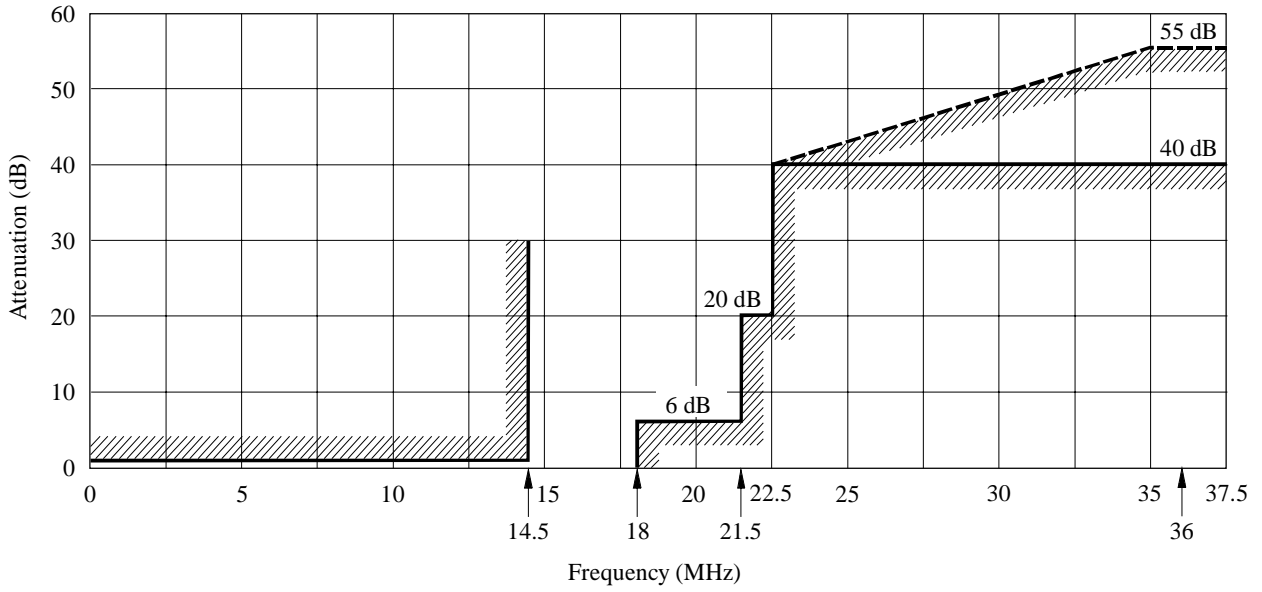

a) Template for insertion loss/frequency characteristic

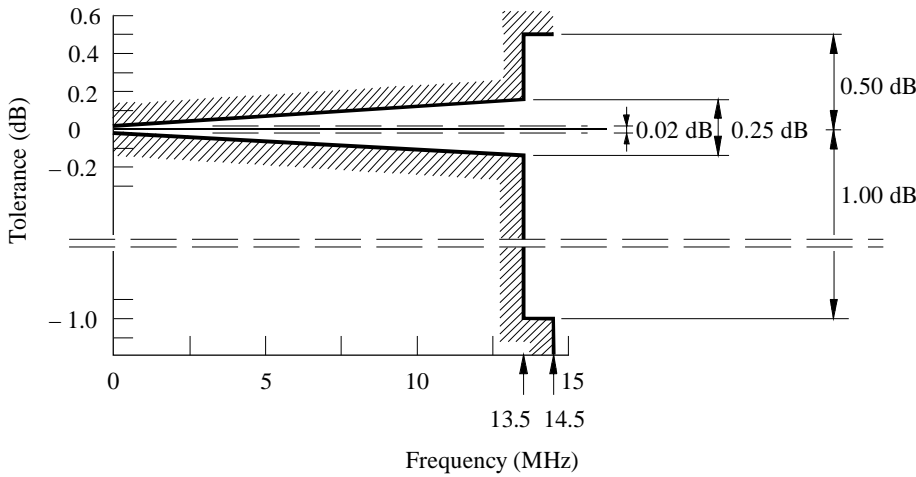

b) Passband ripple tolerance

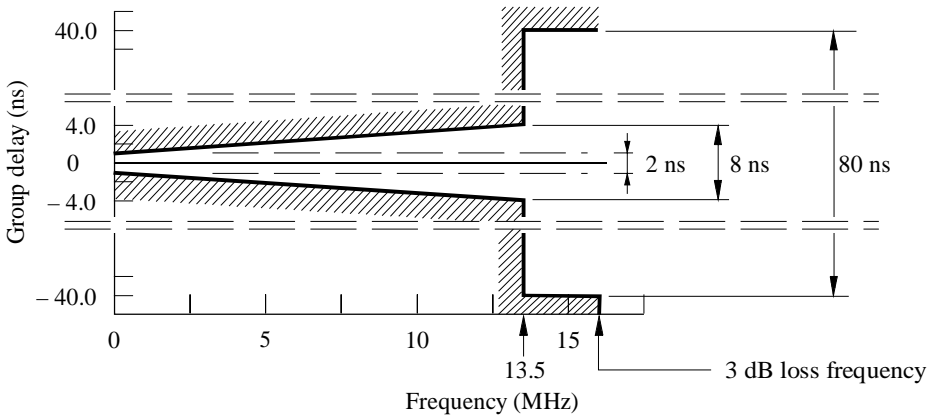

c) Passband group-delay tolerance

*Note 1* – In a digital implementation:

- the insertion loss should be at least 55 dB above 35 MHz (dashed-line template);
- the amplitude/frequency characteristic (on linear scales) should be skew-symmetric about the nail amplitude point;
- the group delay distortion should be zero by design.

*Note 2* – Ripple and group delay are specified relative to their values at 5 kHz.



PART II – HDTV SYSTEMS WITH SQUARE PIXEL COMMON IMAGE FORMAT

II.1 Opto-electronic conversion

Item	Parameter	System			
		1125/60		1250/50	
		1080/60/2:1 (1080/59.94*/2:1)	1080/60/1:1 (1080/59.94*/1:1)	1080/50/1:1	1080/50/2:1
1.1	Opto-electronic transfer characteristics before non-linear pre-correction	Assumed linear			
1.2	Overall opto-electronic transfer characteristics at source <sup>(1)</sup>	$V = 1.099 L^{0.45} - 0.099$ $V = 4.500 L$		for $L \geq 0.018$ for $0.018 > L \geq 0$	
		where $L$ : luminance of the image $0 \leq L \leq 1$ $V$ : corresponding electrical signal			
1.3	Chromaticity coordinates (CIE, 1931) primary - red - green - blue	x	y		
		0.640	0.330		
		0.300	0.600		
		0.150	0.060		
1.4	Assumed chromaticity for equal primary signals (reference white) $E_R = E_G = E_B$	D <sub>65</sub>			
		x	y		
		0.3127	0.3290		

\* The precise value is 60/1.001.

(1) Recommendation ITU-R BT.1361 gives detailed specifications for colorimetric parameters and non-linear characteristics for both the conventional and extended color-gamut systems.

II.2 Picture characteristics

Item	Parameter	System			
		1125/60		1250/50	
		1080/60/2:1 (1080/59.94*/2:1)	1080/60/1:1 (1080/59.94*/1:1)	1080/50/1:1	1080/50/2:1
2.1	Aspect ratio	16:9			
2.2	Samples per active line	1920			
2.3	Sampling lattice	Orthogonal			
2.4	Active lines per picture	1080			
2.5	Pixel aspect ratio	1:1 (Square pixels)			

\* The precise value is 60/1.001.

### II.3 Picture scanning characteristics

Item	Parameter	System			
		1125/60		1250/50	
		1080/60/2:1 (1080/59.94*/2:1)	1080/60/1:1 (1080/59.94*/1:1)	1080/50/1:1	1080/50/2:1
3.1	Order of sample scanning	Left to right, top to bottom For interlace systems, 1st active line of field 1 at top of picture			
3.2	Total number of lines	1125		1250	
3.3	Field/frame frequency (Hz)	60 (60/1.001)		50	
3.4	Interlace ratio	2:1	1:1		2:1
3.5	Picture rate (Hz)	30 (30/1.001)	60 (60/1.001)	50	25
3.6	Line frequency (Hz)	33750 (33750/1.001)	67500 (67500/1.001)	62500	31250
3.7	Line frequency tolerance	0.001%			

\* The precise value is 60/1.001.

NOTE – Values in parentheses are those for the systems 1080/59.94/2:1 and 1080/59.94/1:1.

### II.4 Signal format

Item	Parameter	System			
		1125/60		1250/50	
		1080/60/2:1 (1080/59.94*/2:1)	1080/60/1:1 (1080/59.94*/1:1)	1080/50/1:1	1080/50/2:1
4.1	Conceptual non-linear pre-correction of primary signals	$\gamma = 0.45$ (see §1.2)			
4.2	Derivation of luminance signal $E'Y$	$E'Y = 0.2126 E'R + 0.7152 E'G + 0.0722 E'B$			
4.3	Derivation of color-difference signal (analog coding)	$E'CB = (E'B - E'Y) / 1.8556$ $E'CR = (E'R - E'Y) / 1.5748$			
4.4	Derivation of luminance and color-difference signals (digital coding)	see Recommendation ITU-R BT.1361 <sup>(1)</sup>			

\* The precise value is 60/1.001.

<sup>(1)</sup> Recommendation ITU-R BT.1361 gives general calculation rules to obtain the coefficients for digital coding, as well as the actual coefficients values for 8- to 16-bit quantization systems.

**II.5 Analogue representation**

Item	Parameter	System			
		1125/60		1250/50	
		1080/60/2:1 (1080/59.94*/2:1)	1080/60/1:1 (1080/59.94*/1:1)	1080/50/1:1	1080/50/2:1
5.1	Nominal level (mV) <i>E'R, E'G, E'B, E'Y</i>	Reference black : 0 Reference white : 700 (see Fig. 1 in Part 1)			
5.2	Nominal level (mV) <i>E'CB, E'CR</i>	± 350 (see Fig. 1 in Part 1)			
5.3	Form of synchronizing signal	Tri-level bipolar (see Fig. 2 in Part 1)			
5.4	Line sync timing reference	0H (see Fig. 2 in Part 1)			
5.5	Sync level (mV)	± 300 ± 2%			
5.6	Sync signal timing	Sync on all components (see Table 4 and Fig. 3 in Part 1) (also see Fig. 11)   (also see Fig. 12)			
5.7	Inter-component timing accuracy	Not applicable			
5.8	Blanking interval	(see Table 4 and Fig. 11)		(see Table 4 and Fig. 12)	
5.9	Nominal signal bandwidth (MHz)	(for all components)			
		30	60	30	

\* The precise value is 60/1.001.

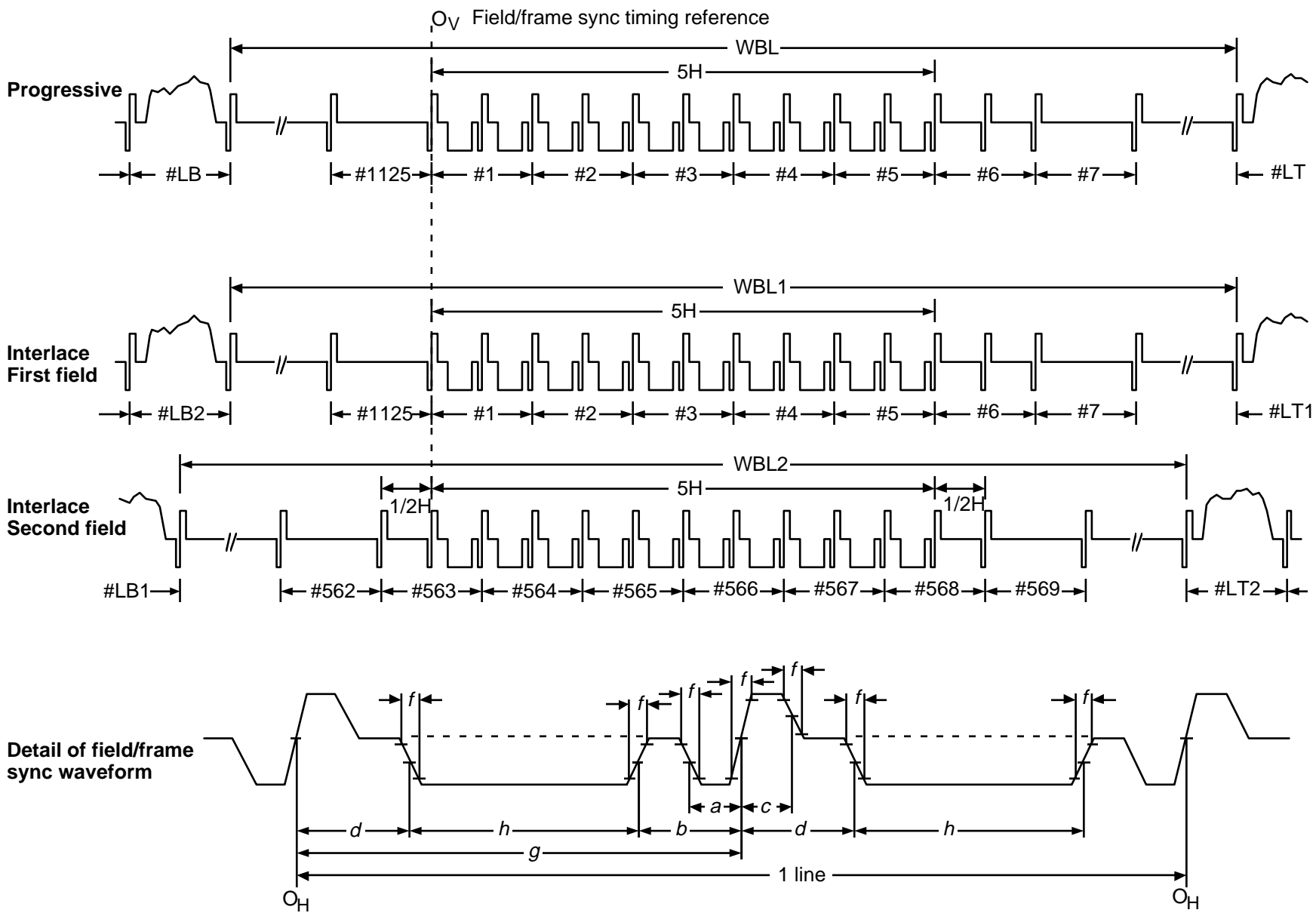

Field/frame synchronizing signal waveform for 1080/60(59) systems

Figure 11

Figure 12

Field/frame synchronizing signal waveform for 1080/50 systems

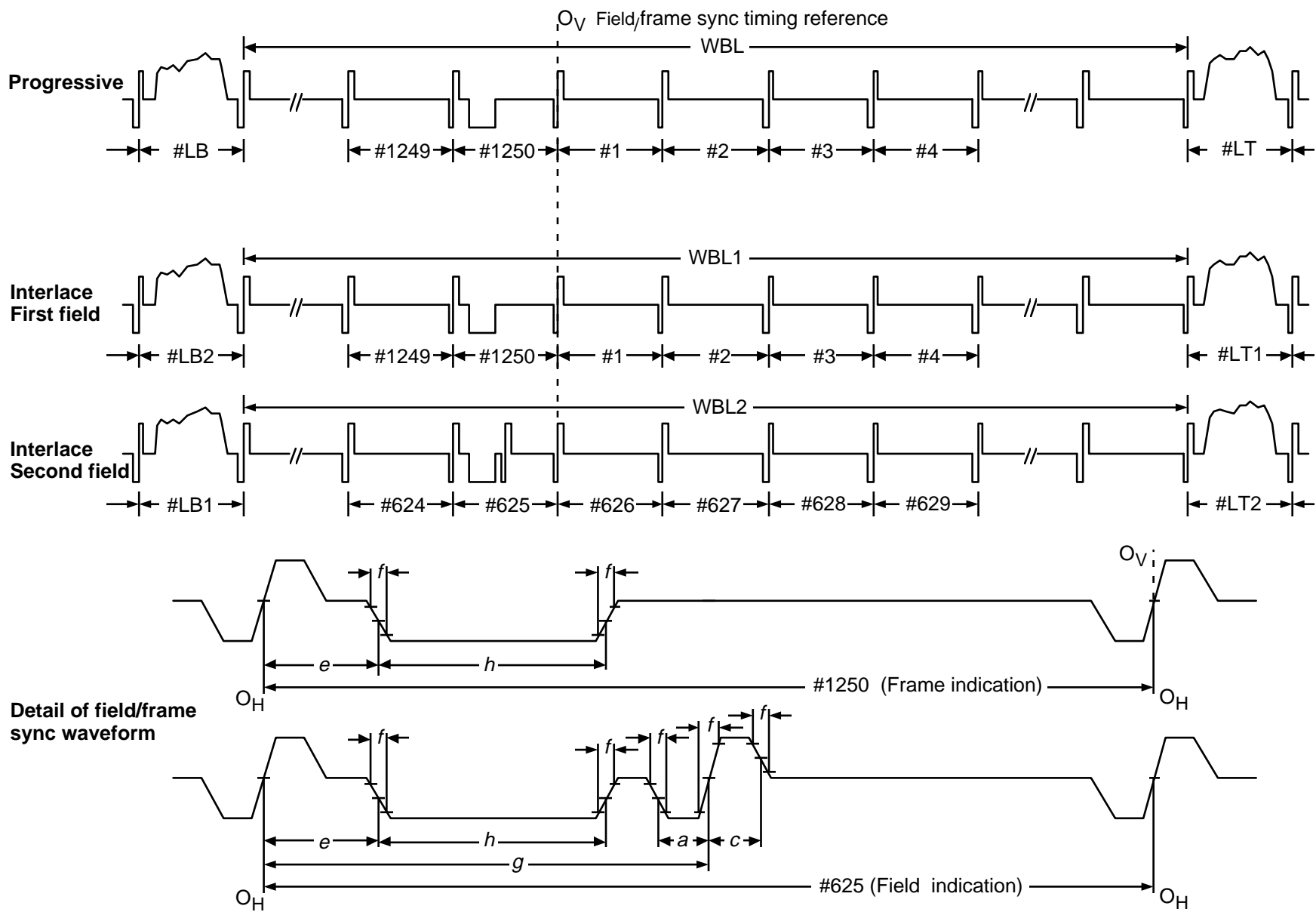

TABLE 4A

## Level and line timing specification for 1080 active line systems

(see Fig. 3 in Part I)

Symbol	Parameter	System			
		1125/60		1250/50	
		1080/60/2:1 (1080/59.94*/2:1)	1080/60/1:1 (1080/59.94*/1:1)	1080/50/1:1	1080/50/2:1
T	Reference clock interval (μs)	1/74.25 (1.001/74.25)	1/148.5 (1.001/148.5)	1/148.5	1/74.25
a	Negative line sync width (T)	44 ± 3		66 ± 3	
b	End of active video (T)	88 <sup>+6</sup> <sub>-0</sub>		147 <sup>+6</sup> <sub>-0</sub>	
c	Positive line sync width (T)	44 ± 3		66 ± 3	
d	Clamp period (T)	132 ± 3		Not applicable	
e	Start of active video (T)	192 <sup>+6</sup> <sub>-0</sub>		309 <sup>+6</sup> <sub>-0</sub>	
f	Rise/fall time (T)	4 ± 1.5			
t <sub>2</sub> - t <sub>1</sub>	Symmetry of rising edge tolerance	Not applicable			
	Active line interval (T)	1920 <sup>+0</sup> <sub>-12</sub>			
S <sub>m</sub>	Amplitude of positive pulse (mV)	300 ± 6			
S <sub>p</sub>	Amplitude of negative pulse (mV)	300 ± 6			
V	Amplitude of video signal (mV)	700			

\* The precise value is 60/1.001.

TABLE 4B

Field/frame timing specification for 1080 active line systems

(see Figs. 11 and 12)

Symbol	Parameter	System			
		1125/60		1250/50	
		1080/60/2:1 (1080/59.94*/2:1)	1080/60/1:1 (1080/59.94*/1:1)	1080/50/1:1	1080/50/2:1
	Total line interval ( T )	2200		2376	
<i>g</i>	Half line interval ( T )	1100		1188	
<i>h</i>	Field/frame sync width ( T )	880 ± 3		594 ± 3	
LT	Top line of picture	# 21	# 42	# 161	# 81
	LT1 : for 1st field	# 21	Not applicable		# 81
	LT2 : for 2nd field	# 584			# 706
LB	Bottom line of picture	# 1123	# 1121	# 1240	# 1245
	LB1 : for 1st field	# 560	Not applicable		# 620
	LB2 : for 2nd field	# 1123			# 1245
WBL	Frame blanking interval	45 H		170 H	
	Field blanking interval				
	WBL1 : for 1st field	22 H	Not applicable		85 H
	WBL2 : for 2nd field	23 H			85 H
	Start of - frame	# 1			
	- 1st field	# 1			# 1
	- 2nd field	# 564	Not applicable		# 626

\* The precise value is 60/1.001.

NOTES

“T” denotes the duration of a reference clock or the reciprocal of the clock frequency (see Table 4A).

“H” denotes the duration of a line or the reciprocal of the line frequency (see § 3).

A “line” starts at line sync timing reference O<sub>H</sub> (inclusive), and ends at just before the subsequent O<sub>H</sub> (exclusive).

## II.6 Digital representation

Item	Parameter	system			
		1125/60		1250/50	
		1080/60/2:1 (1080/59.94*/2:1)	1080/60/1:1 (1080/59.94*/1:1)	1080/50/1:1	1080/50/2:1
6.1	Coded signal	$R, G, B$ or $Y, C_B, C_R$			
6.2	Sampling lattice - $R, G, B, Y$	Orthogonal, line and picture repetitive			
6.3	Sampling lattice - $C_B, C_R$	Orthogonal, line and picture repetitive co-sited with each other and with alternative <sup>(1)</sup> $Y$ samples			
6.4	Sampling frequency (MHz) - $R, G, B, Y$	$74.25 \pm 0.001\%$ ( $74.25 / 1.001 \pm 0.001\%$ )	$148.5 \pm 0.001\%$ ( $148.5 / 1.001 \pm 0.001\%$ )	$148.5 \pm 0.001\%$	$74.25 \pm 0.001\%$
6.5	Sampling frequency (MHz) - $C_B, C_R$	Half of luminance sampling frequency			
		$37.125 \pm 0.001\%$ ( $37.125 / 1.001 \pm 0.001\%$ )	$74.25 \pm 0.001\%$ ( $74.25 / 1.001 \pm 0.001\%$ )	$74.25 \pm 0.001\%$	$37.125 \pm 0.001\%$
6.6	Number of samples per full line - $R, G, B, Y$ - $C_B, C_R$	2200 1100		2376 1188	
6.7	Active number of samples per line - $R, G, B, Y$ - $C_B, C_R$	1920 960			
6.8	Coding format	Linear 8 or 10 bits/component			
6.9	Timing relationship between the analog synchronizing reference $O_H$ and video data	192 T		309 T	
6.10	Quantization levels - Black level $R, G, B, Y$ - Achromatic $C_B, C_R$ - Nominal peak - $R, G, B, Y$ - $C_B, C_R$	8 bit coding 16 128 235 16 and 240		10 bit coding 64 512 940 64 and 960	
6.11	Quantization level assignment - Video data - Timing reference	8 bit coding 1 through 254 0 and 255		10 bit coding 4 through 1019 0 - 3 and 1020 - 1023	
6.12	Filter characteristics <sup>(2)</sup> - $R, G, B, Y$ - $C_B, C_R$	see Fig. 13A see Fig. 13B		see Fig. 14A see Fig. 14B	

\* The precise value is 60/1.001.

<sup>(1)</sup> The first active color-difference samples being co-sited with the first active luminance sample.

<sup>(2)</sup> These filter templates are defined as guidelines.



FIGURE 13A  
 Filter characteristics for *R*, *G*, *B* and *Y* signals  
 for the 1080/60(59) systems

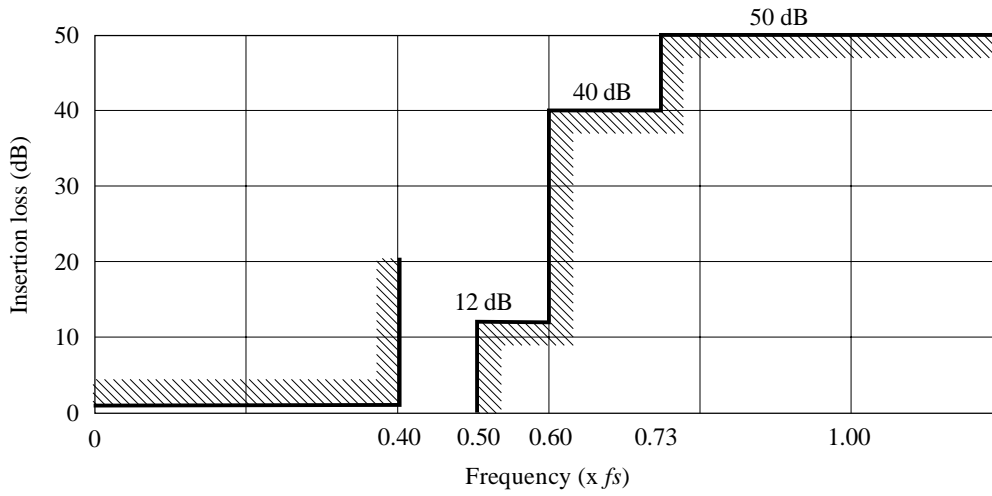

a) Template for insertion loss

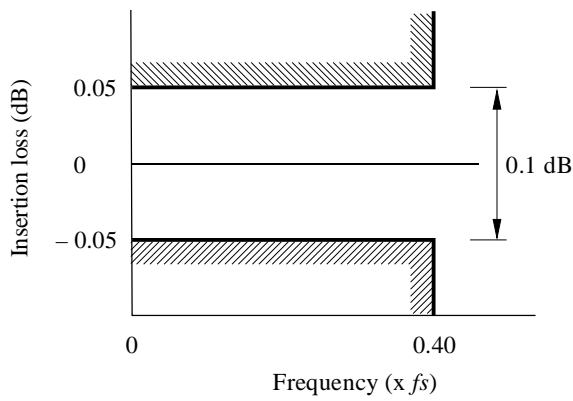

b) Passband ripple tolerance

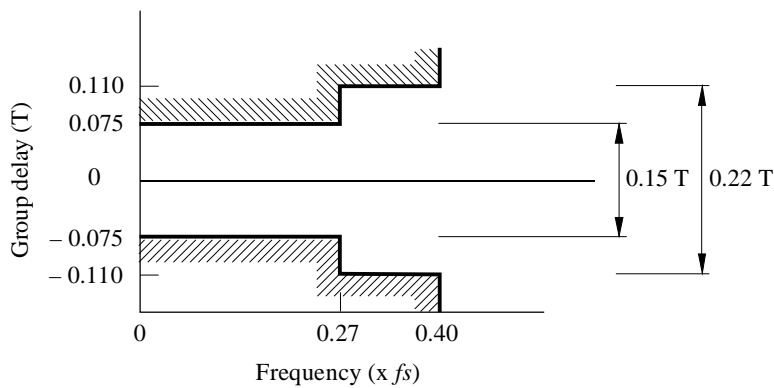

c) Passband group-delay

Note 1 –  $f_s$  denotes luminance sampling frequency, the value of which is given in § 6.4.

Note 2 – Ripple and group delay are specified relative to their values at 100 kHz.

FIGURE 13B  
 Filter characteristics for  $C_B$  and  $C_R$  signals  
 for the 1080/60(59) systems

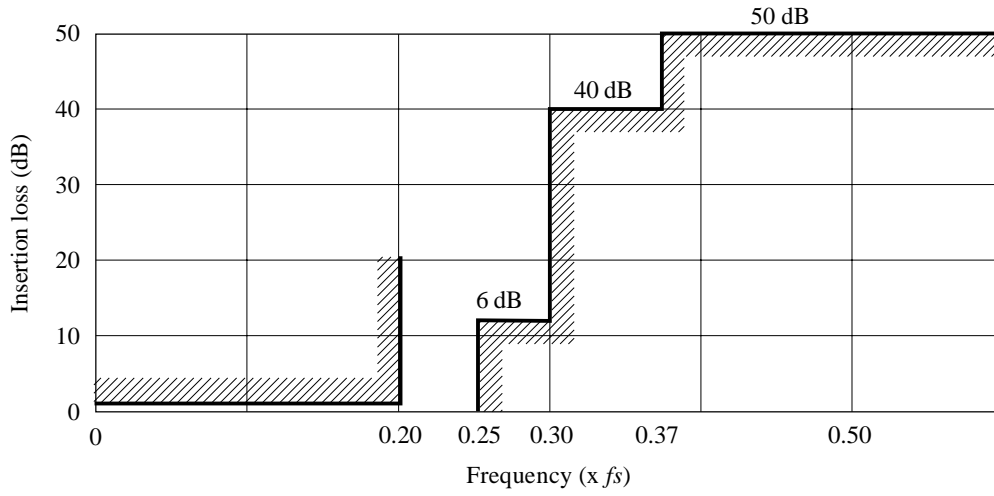

a) Template for insertion loss

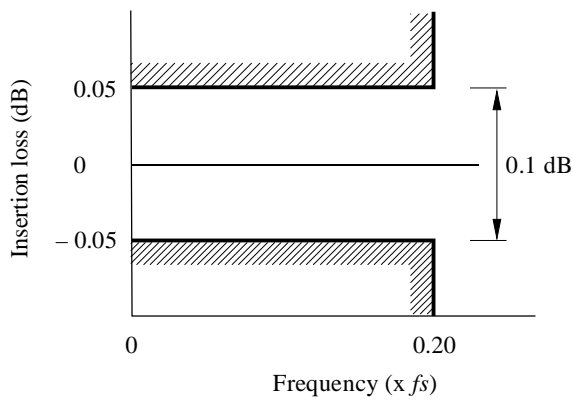

b) Passband ripple tolerance

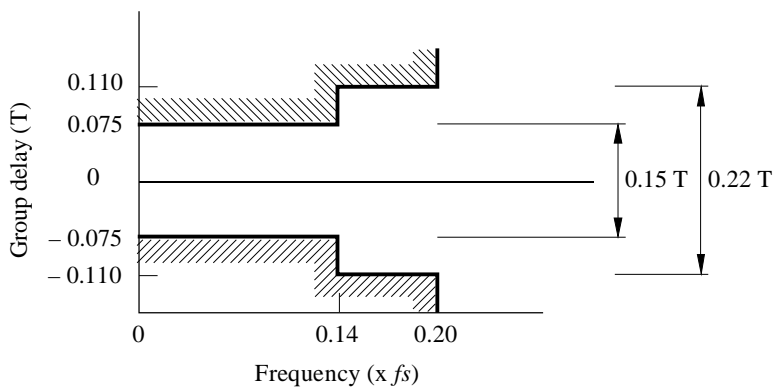

c) Passband group-delay

Note 1 –  $f_s$  denotes luminance sampling frequency, the value of which is given in § 6.4.

Note 2 – Ripple and group delay are specified relative to their values at 100 kHz.

FIGURE 14A

Filter characteristics for R, G, B and Y signals for the 1080/50 systems

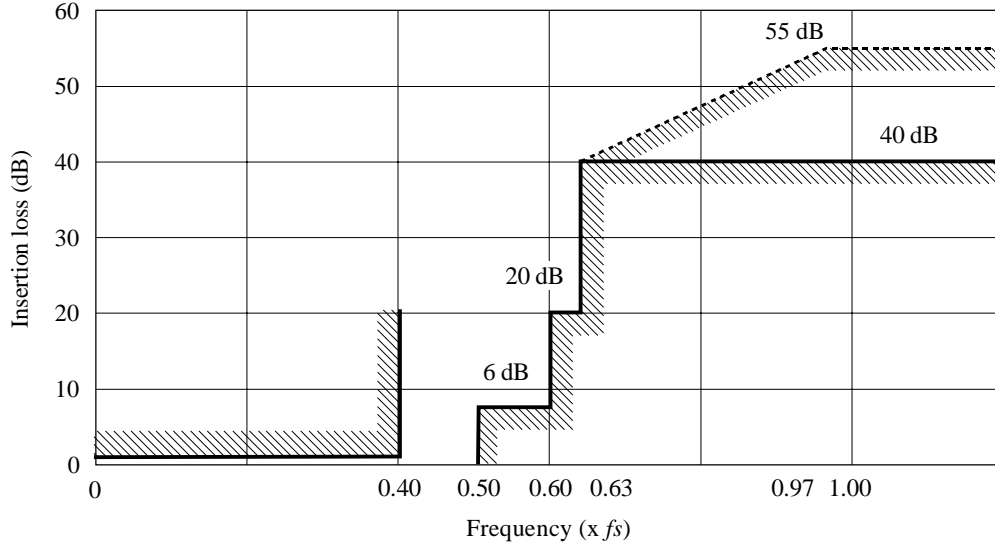

a) Template for insertion loss

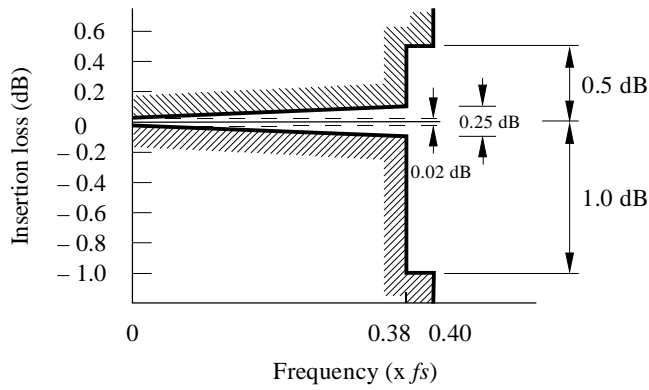

b) Passband ripple tolerance

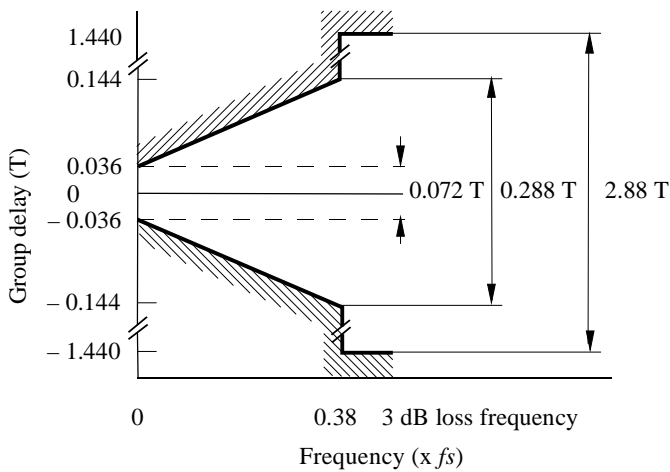

c) Passband group delay

Note 1 –  $f_s$  denotes luminance sampling frequency, the value of which is given in § 6.4.

Note 2 – Ripple and group delay are specified relative to their values at 100 kHz.

Note 3 – In a digital implementation, the insertion loss should be at least 55 dB above 0.97  $f_s$  (dashed line template); the amplitude/frequency characteristic (on linear scales) should be skew-symmetric about the nominal amplitude point; and the group-delay distortion should be zero by design.

FIGURE 14B  
Filter characteristics for  $C_B$  and  $C_R$  signals for the 1080/50 systems

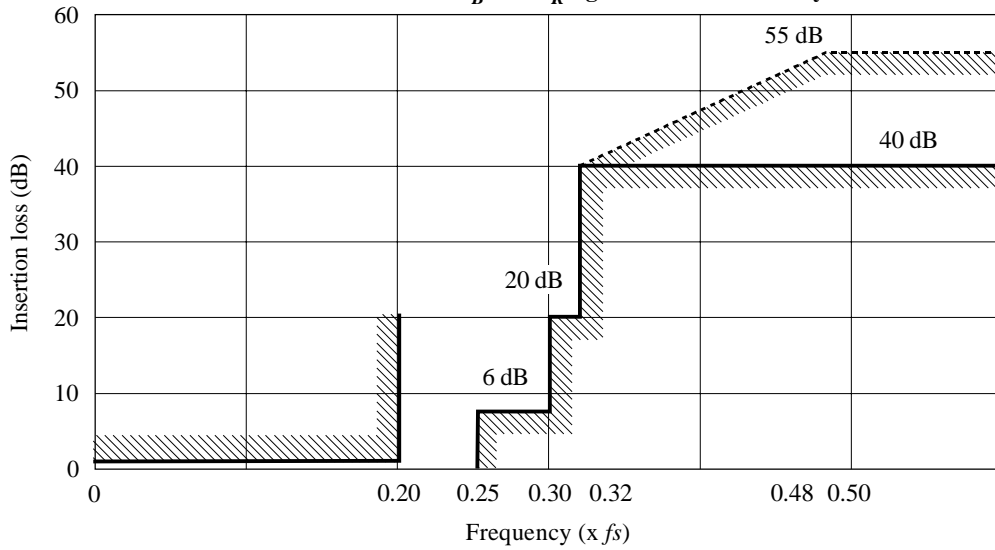

a) Template for insertion loss

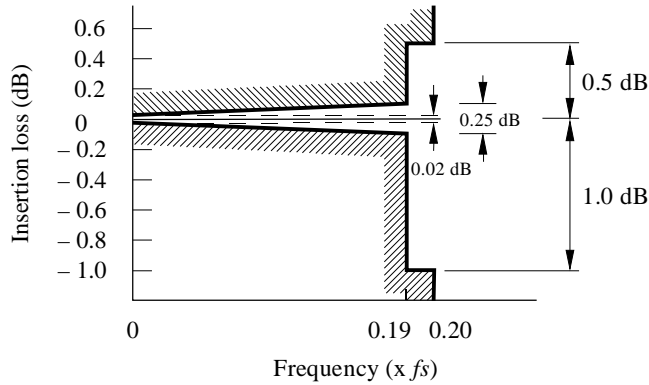

b) Passband ripple tolerance

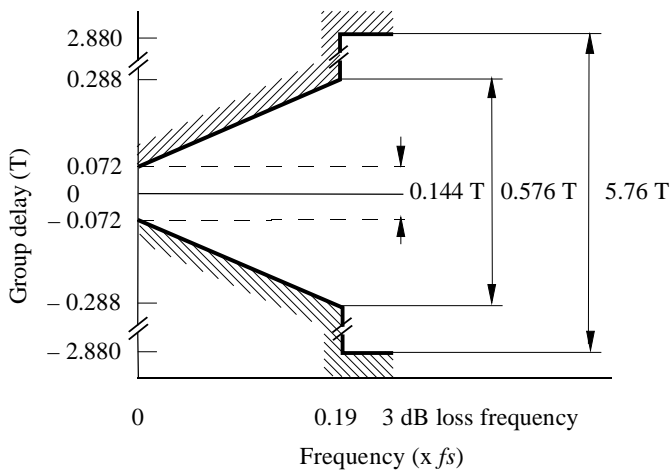

c) Passband group delay

Note 1 –  $f_s$  denotes luminance sampling frequency, the value of which is given in § 6.4.

Note 2 – Ripple and group delay are specified relative to their values at 100 kHz.

Note 3 – In a digital implementation, the insertion loss should be at least 55 dB above  $0.97 f_s$  (dashed line template); the amplitude/frequency characteristic (on linear scales) should be skew-symmetric about the nail amplitude point; and the group-delay distortion should be zero by design.