

APPROVAL SHEET



Model No. : DVB56R

Description : 5.6 inch TFT LCD Driving Board

Revision: 1.0

Date: April. 4th, 2001

Project Leader approved Sign: _____

Prepared By Design Engineer	Reviewed By Project Leader	Issued By D.C.C.
 4/17 2001	 4/17 2001	 4/17/2001

Color TFT LCD Driving Board Specification

DVB56R

Contents:

General Description	3
Features	3
Application Precautions.....	3
Driving Board Function Block.....	4
Outline Drawing.....	4
Connector Pin Definition.....	5
General Specification.....	7
Driving Board Specification.....	7
Inverter Specification.....	9
Environment characteristics.....	9
PCB Layout Drawing.....	10
Mechanical Drawing.....	12

Color TFT LCD Driving Board Specification

DVB56R

General Description:

DVB56R Color TFT LCD Driving Board is applied to drive Unipac's UP056D01 5.6" Color TFT LCD Panel. The Driving Board provides all the needs in converting Composite video signal to the proper interface of LCD Panel and the CCFL Inverter. It can accept NTSC and PAL Video signal input, and it will switch the current video system by itself.

Features:

- Composite Video Input (1.0Vpp)
- Separate RGB Video signal (0.7Vpp)
- NTSC/PAL auto-switching
- UP/Down and Left/Right shift control for LCD Panel display
- Synchronous signal output: HSY: Horizontal Sync. Signal
VSY: Vertical Sync. Signal
- External control Pin out : TIN :Tint
COL: Color
BRT: Brightness
CNT: Contrast
PIC: Picture sharpness
LR: Display Left and Right inversion
UD: Display Up and Down inversion
SW: Composite Video signal or Separate RGB Video signal switch
- With Separate Inverter

Application precautions:

The products covered herein are designed and manufactured for the following application areas.

1. Office electronics
2. Instrumentation and measuring equipment
3. Machine tools
4. Audiovisual equipment
5. Home appliances
6. Communication equipment other than for trunk lines

Do not use the products covered herein for the following equipment that demands extremely high performance in terms of functionality, reliability, or accuracy.

1. Aerospace equipment
2. Communication equipment for trunk lines
3. Medical equipment related to life support, etc.

Color TFT LCD Driving Board Specification

DVB56R

The other application that demands high reliability and functionality should first contact a sales representative.

Driving Board Function Block

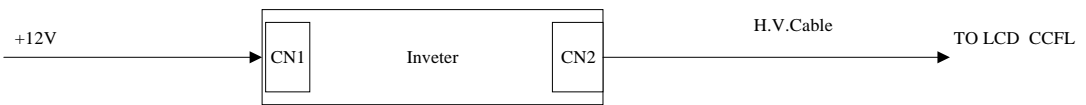
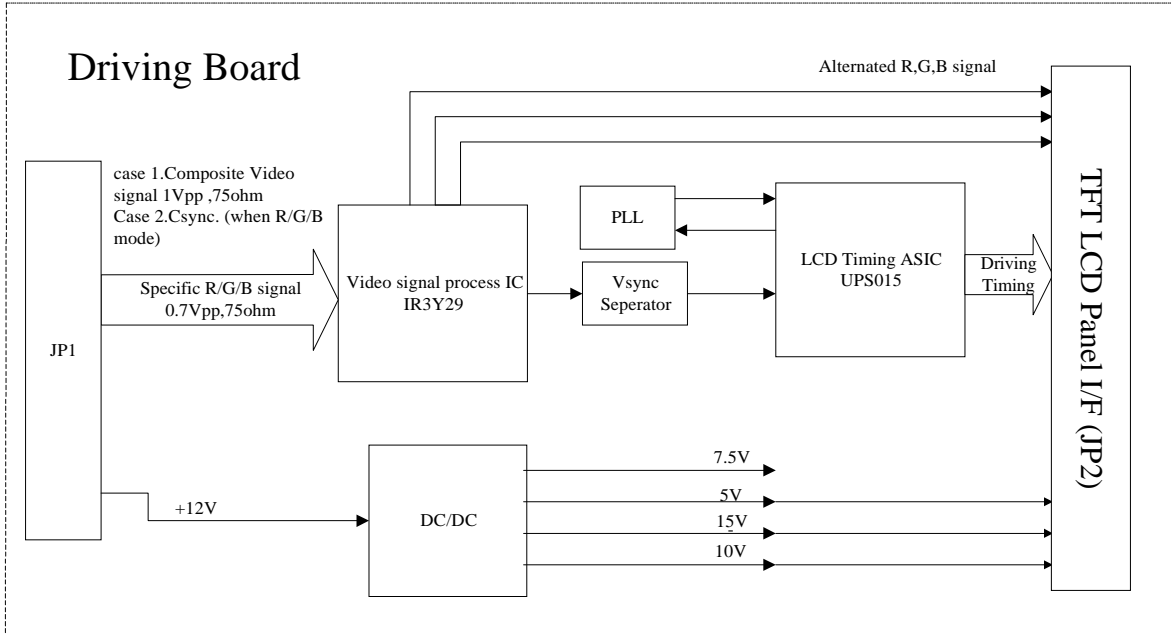

Outline drawing

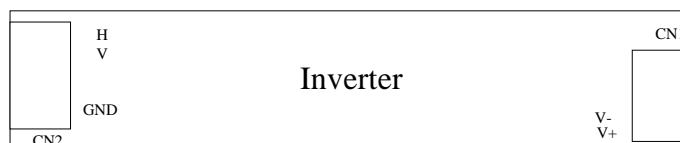
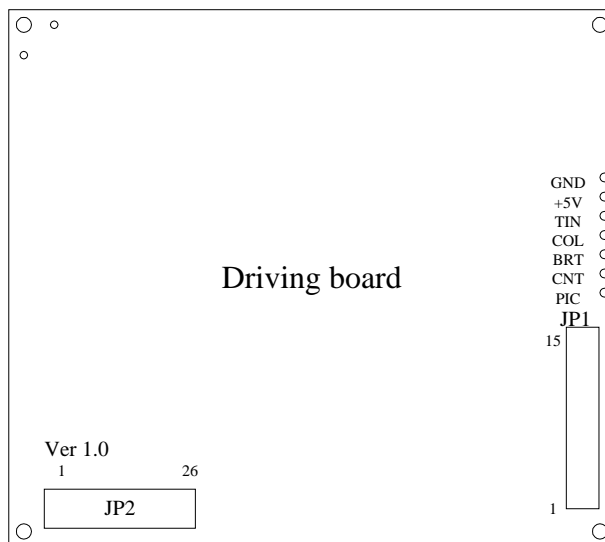

Color TFT LCD Driving Board Specification

DVB56R

Connector Pin Definition

JP1: Pin assignment of User Control Interface on driving board :

Used connector: Molex 53398-1590 or Equivalent

Related female housing: Molex 51021-1500 or Equivalent

Pin No.	Pin Assignment	I/O	Pin Description	Remark
1	/Hsync	O	Horizontal Sync. Output for specific Application.	
2	/Vsync	O	Vertical Sync. Output for specific Application.	
3	NPC	I/O	NTSC/PAL mode selection.	Note 1
4	SW	I	Composite/Analog RGB Signal Selection.	Note 2
5	CVS	I	Composite Video Signal Input.	
6	Bin	I	Separated Blue Video Signal Input.	
7	Rin	I	Separated Red Video Signal Input.	
8	Gin	I	Separated Green Video Signal Input.	
9	GND	-	Ground	
10	GNDS	-	Ground	
11	Vin	I	12 Voltage DC Input	
12	GNDS	-	Ground	
13	COL	I	Color terminal adjustment	
14	LR	I	Left/Right scan selection	Note 3
15	UD	I	Up/Down scan selection	Note 4

Default means Factory Setting.

Note 1: Default is auto detect for NTSC and PAL system.

(Controlled by internal UPS015)

High for NTSC mode and Low for PAL mode.

Note 2: Default is Composite Signal (Low);

High is for separated Analog RGB signals.

Note 3: Default is reversed scanning (High) and Low is for normal scanning (L → R).

Please do force this pin to ground for normal scan, from left to right.

Note 4: Default is reversed scanning (High) and Low is for normal scanning (U → D).

Please do force this pin to ground for normal scan from up to down.

Color TFT LCD Driving Board Specification DVB56R

JP2 LCD panel I/F (FPC 26pin)

Used connector: ELCO 08-6210-026 or Equivalent (below contact type)

Related cable: 26 Pin FPC

Pin no.	Symbol	i/o	Description	Remark
1	GND	-	Ground for logic circuit	
2	VCC	I	Supply voltage for control circuit of scan driver	
3	VGL	I	Negative power for scan driver	
4	VGH	I	Positive power for scan driver	
5	STVR	I/O	Vertical start pulse	Note 1
6	STVL	I/O	Vertical start pulse	Note 1
7	CKV	I	Shift clock input for scan driver	
8	U/D	I	UP/DOWN scan control input	Note 1, 2
9	OEV	I	Output enable input for scan driver	
10	VCOM	I	Common electrode driving signal	
11	VCOM	I	Common electrode driving signal	
12	L/R	I	LEFT/RIGHT scan control input	Note 1,2
13	Q1H	I	Analog signal rotate input	
14	OEH	I	Output enable input for data driver	
15	STHL	I/O	Start pulse for horizontal scan line	Note 1
16	STHR	I/O	Start pulse for horizontal scan line	Note 1
17	CPH3	I	Sampling and shifting clock pulse for data driver	
18	CPH2	I	Sampling and shifting clock pulse for data driver	
19	CPH1	I	Sampling and shifting clock pulse for data driver	
20	VCC	I	Supply voltage of control circuit for data driver	
21	GND	-	Ground for logic circuit	
22	VR	I	Alternated video signal input (Red)	
23	VG	I	Alternated video signal input (Green)	
24	VB	I	Alternated video signal input (Blue)	
25	AVDD	I	Supply voltage for analog circuit	
26	AVSS	-	Ground for analog circuit	

Note 1 : Selection of scanning mode – refer to page 5 of UP056D01 spec.

Note 2 : Definition of scanning direction – refer to page 5 of UP056D01 spec.

Color TFT LCD Driving Board Specification

DVB56R

Additional control row

Dimension: Dia.1.2 mm; pitch 2.54 mm

Symbol	i/o	Description
GND	-	Ground for ext. control
+5V	O	+5V power supply for ext. control
TIN	I	Tint
COL	I	Hue
BRT	I	Brightness
CNT	I	Contrast
PIC	I	Sharpness

Inverter Connector Pin Definition

Input connector:CN1 JST S5B-PH-K or Equivalent

Pin No.	Symbol	Description
1	V+	12Vdc input terminal
2	V-	GND
3,4,5	N.C.	-----

Output connector:CN2 JST S 02(8.0)B-BHS or Equivalent

Pin No.	Symbol	Description
1	H.V	High voltage output
2	GND	GND

General Specification

1. Driving board Specification:

Input requirement

Connector	Pin No.	Symbol	Condition	Rating
JP1	5	CVS		1.0Vpp Composite Video (meet RS170 standard and PAL Video standard)
	6,7,8	Bin,Rin,Gin		0.7Vpp Analog R,G,B (75ohm Loading)
	11	Vin		12Vdc \pm 10%
		Iin	Vin=12Vdc	0.1 Amp \pm 10% (typical)
Input Characteristic				
Power Consumption			Vin=12Vdc	1.2W(typical)

Color TFT LCD Driving Board Specification DVB56R

User Control requirement

Connector	Pin No.	Symbol	Condition	Rating	
				High	Low/Open
JP1	4	SW		High	Low/Open
				+5V(typical)	0V
	14	LR		High/Open	Low
				+5V(typical)	0V
	15	UD		High/Open	Low
				+5V(typical)	0V

User Control requirement :OSD control function (recommended Value)

Symbol	Condition	Adjusted Voltage			Remark
		Min.	Typical	Max.	
TIN	V _{cc} =5V	3V	3.2V	4V	Note 1
COL		2.6V	3.3V	4V	
BRT		2.05V	2.1V	2.16V	
CNT		2.13V	3.03V	3.13V	Note 2
PIC		1.0V	1.5V	3.6V	

Note 1: The TIN is only operating in NTSC system.

Note 2: We don't suggest to adjust "CNT" from Variable resistor on the driving board.

Output Electrical characteristics

LCD Panel driving output

Item	Position	Symbol	Min.	Typical	Max.	Remark
Power supply	JP2,pin2	V _{CC} ,AV _{DD}	4.9V	5V	5.1V	
	JP2,pin4	V _{GH}	13V	15V	17V	
	JP2,pin3	V _{GLAC}	4.9Vpp	5.0Vpp	5.1Vpp	AC component of V _{GL}
		V _{GLDC}	-11V	-10V	-9V	DC component of V _{GL}
Video signal amplitude(VR, VG, VB)		V _{iAC}		3V		AC component
VCOM	JP2,pin10,11	VCAC	4.9Vpp	5.0Vpp	5.1Vpp	AC component
		VCDC	1.3V	1.4V	1.5V	DC component

Color TFT LCD Driving Board Specification

DVB56R

2. Inverter Specification

Input Requirement						
Connector	Pin No.	Symbol	Condition	Rating		
				Min.	Typical	Max.
CN1	1	V _{in} (V+)	@25°C	11.8Vdc	12Vdc	12.2Vdc
		I _{in}	V _{in} =12Vdc	-----	0.36Adc	0.37Adc
Power Consumption			V _{in} =12Vdc	4.32W(typical)		
Output Characteristic						
Connector	Pin No.	Symbol	Condition	Rating		
				Min.	Typical	Max.
CN2	1	V _L (H.V)	@25°C	-----	560Vrms	-----
		I _L	V _{in} =12Vdc	5mArms	6mArms	7mArms
		Frequency		55KHz	60KHz	65KHz

Environment characteristics

Operating Temperature: 0 ~ +60 °C

Relative Humidity: 5 ~95% RH

Storage Temperature: -25 ~ +80 °C

Relative Humidity: 0 ~95% RH

Color TFT LCD Driving Board Specification

DVB56R

PCB Layout Drawing

TOP Silk Screen

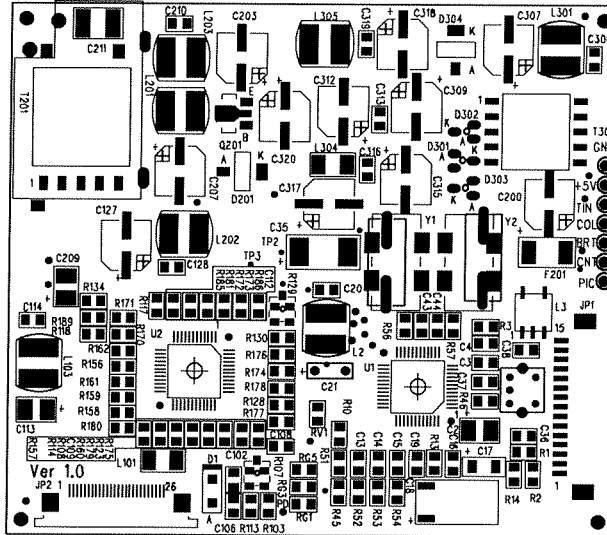

Bottom Silk Screen

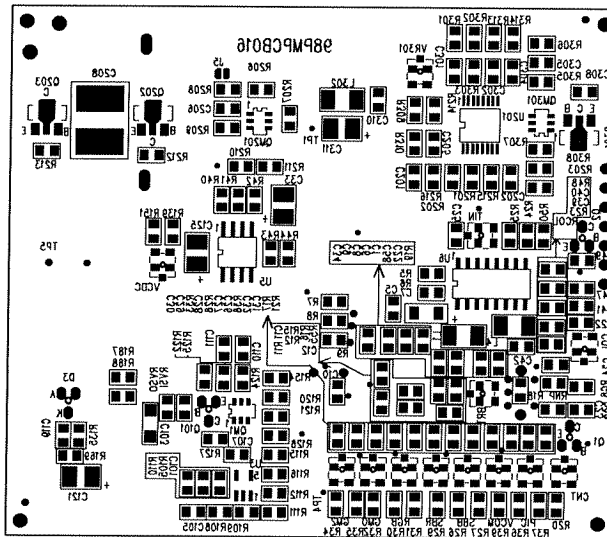

Color TFT LCD Driving Board Specification

DVB56R

PCB Layout Drawing

Component Side

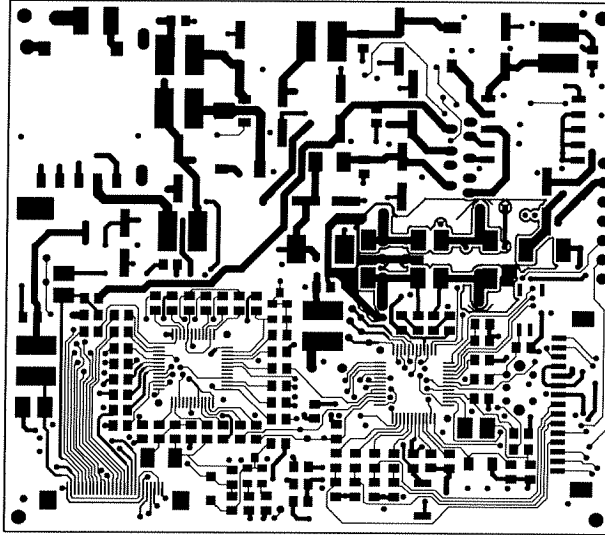

Solder Side

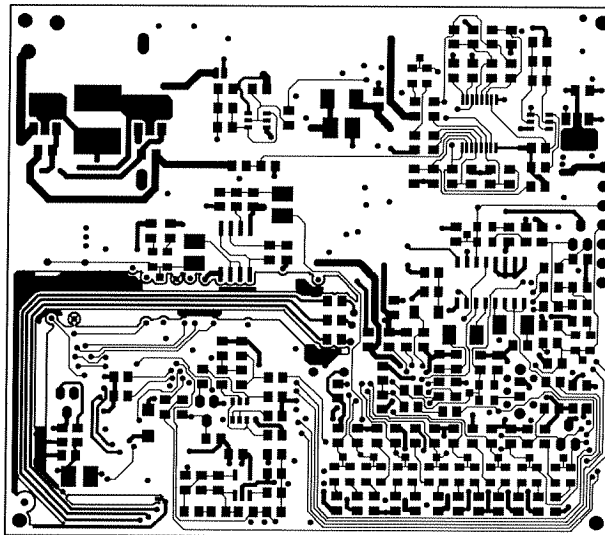

Color TFT LCD Driving Board Specification DVB56R

Mechanical Drawing

Unit:mm

Driving board

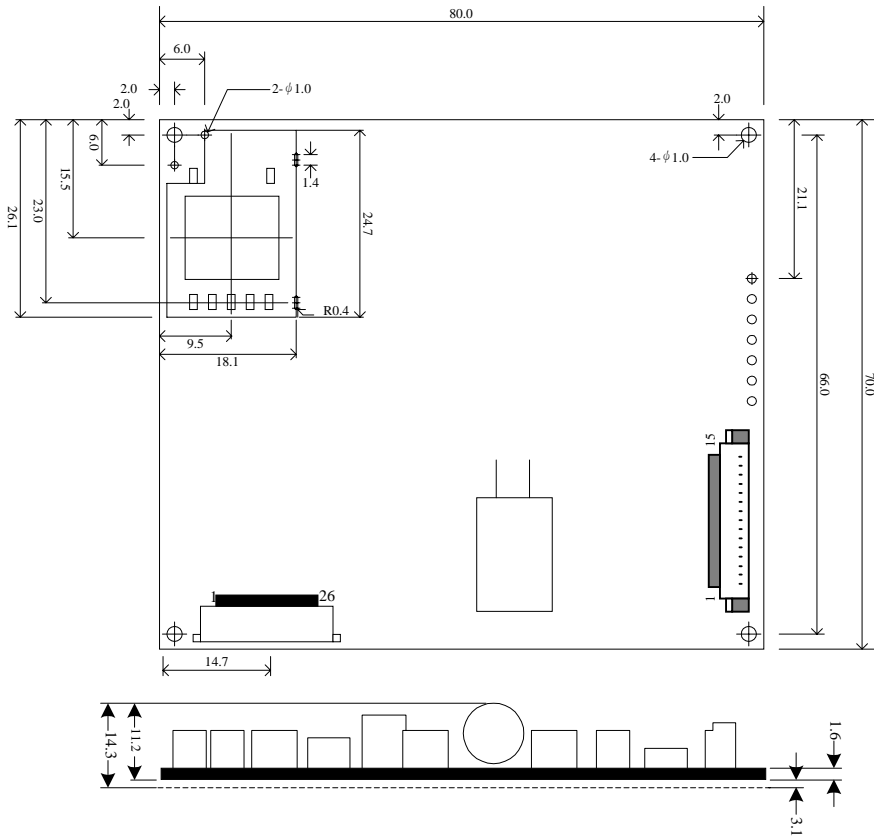

Inverter

